

Universal Axle Collars UNIFIT Car

- Flexible collars for ease of mounting

Application Area

- For all car types

Characteristics

- Material thickness approx. 2.3 mm, elasticity 600 %

Scope Of Delivery

- Including a 60 gram bag long-term fat

Technical Data

Stock-Ø	95 mm
---------	-------

Title	PU Piece	Article No.
UNIFIT Axle Collar Set for Cars	1	157620

AGR: 16.910

Accessories Available	PU Piece	Article No.
Axle Collar Assembly Tool	1	020238

Spare Parts	PU Piece	Article No.
Axle Collars – Stainless Steel Strap short 25 - 50 mm int. Tooth	20	145060
Stainless-Steel Axle Collar Set, long 40 - 110 mm, int. Tooth	20	145059



Universal Axle Collars UNIFIT for Transporters

- Extremely flexible collars for ease of mounting

Application Area

- For off-road vehicles and transporters

Characteristics

- Elasticity 600%

Processing Information

- For Fiat Ducato, Peugeot Boxer and Citroen Jumper a flatter metal strap is to be used for the larger diameter.

Scope Of Delivery

- Including a 60 gram bag long-term fat

Technical Data

Stock-Ø 115 mm

Title	PU Piece	Article No.
UNIFIT Axle Collar Set for Transporters	1	171089

AGR: 16.910

Accessories Available	PU Piece	Article No.
Axle Collar Assembly Tool	1	020238

Spare Parts	PU Piece	Article No.
Axle Collars – Stainless Steel Strap short 25 - 50 mm int. Tooth	20	145060
Stainless-Steel Axle Collar Set, long 40 - 110 mm, int. Tooth	20	145059

Self-locking Metal Straps

- Self locking, thus ease of mounting
- Universally usable thanks to large clamping range
- Stainless steel, thus anti-magnetic and corrosion-resistant
- No wear of the material to be bundled

Application Area

- In extreme ambient temperature
- for the attachment of
- Universal CV boot
- with strong chemical
- Agents and radioactive radiations

Technical Data

Material Stainless Steel antimagnetic

Title	Length	Width	Band Thickness	Tensile Strength	PU Piece	Article No.
Metal Strap MBK	360 mm	4.6 mm	0.25 mm	445 N	25	139258
Metal Strap MBK	520 mm	4.6 mm	0.25 mm	445 N	25	139259
METAL STRIP MBK 679X4.6X0.25	697 mm	4.6 mm	0.25 mm	445 N	25	139260

AGR: 16.911



Metal Tightening Strap

- Good pressure distribution thanks to large strap width
- Universally usable thanks to large clamping range
- High clamping force if collet chucks are used
- Stainless steel, thus anti-magnetic and corrosion-resistant
- No wear of the material to be bundled

Processing Information

- Collet chucks are to be used

Technical Data

Material		Stainless Steel		
Title	Length	Width	PU Piece	Article No.
Stainless Steel Cable Strap	480 mm	6.3 mm	25	139263
AGR: 16.911				
Accessories Available			PU Piece	Article No.
Collet Chuck			1	121798



Axle Collars Clamp Fitting Strap

- Good pressure distribution thanks to large strap surface
- Easy mounting as tothing is hooked-in before clamping
- In the case of the version with internal tothing, the strap does not need to be shortened
- Stainless steel, thus anti-magnetic and corrosion-resistant
- Universally usable thanks to high clamping range

Processing Information

- Use clip pliers

Technical Data

Material Stainless Steel antimagnetic



Title	Clamping range	Width	Tothing	PU Piece	Article No.
Stainless-Steel Axle Collar Set, long	40 - 110 mm	7 mm	Internal tooth	20	145059
Axle Collars – Stainless Steel Strap short	25 - 50 mm	7 mm	Internal tooth	20	145060

AGR: 16.911

Accessories Available

	PU Piece	Article No.
Clamping Tongs AMS 10	1	885380

Axle Collar Gripper Clamps

- Good pressure distribution thanks to large strap surface
- Smooth strap surface prevents any damage to collars
- Factory-original version of most vehicle manufacturers

Processing Information

- Clamping Tongs are to be used

Technical Data

Material Sheet steel zinc plated



Title	Clamping range	Width	PU Piece	Article No.
Axle Collar Gripper Clamps	22 - 29 mm	7 mm	25	914029
Axle Collar Gripper Clamps	29 - 35 mm	7 mm	25	914037
Axle Collar Gripper Clamps	31 - 37 mm	7 mm	25	914045
Axle Collar Gripper Clamps	37 - 44 mm	7 mm	25	914053
Axle Collar Gripper Clamps	70 - 78 mm	9 mm	25	914061
Axle Collar Gripper Clamps	81 - 88 mm	9 mm	25	914070
Axle Collar Gripper Clamps	90 - 97 mm	9 mm	25	914088

AGR: 16.911

Accessories Available

	PU Piece	Article No.
Clamping Tongs AMS 10	1	885380

Clamping Tongs

- Less expenditure of energy thanks to long lever (one- hand operation)
- Clamping and pressing in order to create material bulging and to provide some clearance towards adjacent components
- Robust version for a prolonged lifetime

Application Area

- Easy and clean clamping of axle collar clamping straps and axle collar gripper clamps



Title	PU Piece	Article No.
Clamping Tongs AMS 10 AGR: 16.910	1	885380

Collet Chuck

- Tensioning, crimping and cutting with 1 tool
- Ratchet function for fast tensioning

Application Area

- Easy and clean tensioning, crimping over and cutting of metal straps



Title	PU Piece	Article No.
Collet Chuck AGR: 16.910	1	121798

License Plate Holder premium

- The narrow design does not distract parking sensors or rear view cameras
- Flexible - adapts to streight or arched bodies

Hints

- Available with a screen printing or an epoxy resin coating
- For fastening use flat headed screws
- EU-conform - all requirements of the EG-guidelines 74/483/EWG fulfilled, because all of the outer edges are equipped with the required minimal radius of curvature of 2.5 mm



Title	Printing	Content	PU Piece	Article No.
NUMBERPLATE HOLDER PREMIUM	(Translation missing)	1	1	054369
NUMBERPLATE HOLDER PREM.1C	1-colored	150	1	054370*
HOLDER PREM. 1COLOIUR SCALE 1	1-colored	300	1	054536*
HOLDER PREM. 1COLOUR SCALE 2	1-colored	600	1	054542*
HOLDER PREM. 1COLOUR SCALE 3	1-colored	1050	1	054548*
NUMBERPLATE HOLDER PREM.2C	2-colored	150	1	054371*
HOLDER PREM. 2COLOUR SCALE 1	2-colored	300	1	054537*
HOLDER PREM. 2COLOUR SCALE 2	2-colored	600	1	054543*
HOLDER PREM. 2COLOUR SCALE 3	2-colored	1050	1	054549*
NUMBERPLATE HOLDER PREM.3C	3-colored	150	1	054372*
HOLDER PREM. 3COLOUR SCALE 1	3-colored	300	1	054538*
HOLDER PREM. 3COLOUR SCALE 2	3-colored	600	1	054544*
HOLDER PREM. 3COLOUR SCALE 3	3-colored	1050	1	054551*
NUMBERPLATE HOLDER PREM.4C	4-colored	150	1	054373*
HOLDER PREM. 4COLOUR SCALE 1	4-colored	300	1	054539*
HOLDER PREM. 4COLOUR SCALE 2	4-colored	600	1	054545*
HOLDER PREM. 4COLOUR SCALE 3	4-colored	1050	1	054552*
HOLDER PREM. EPOXY SCALE 1	Epoxy	300	1	054540*
HOLDER PREM. EPOXY SCALE 2	Epoxy	600	1	054546*
HOLDER PREM. EPOXY SCALE 3	Epoxy	1050	1	054553*

AGR: 16.540

License Plate Holder neutral

- Robust design
- Special spring elements provide a fast ejection of the vehicle registration number

Processing Information

- Particularly suitable for interchangeable number plates

Hints

- Available with a screen printing or an epoxy resin coating



Title	Printing	Content	Color	PU Piece	Article No.
NUMBERPLATE HOLDER TOP LINE	(Translation missing)	1	black	1	054375
NUMBERPLATE HOLDER TOP 1C	1-colored	150	-	1	054376*
HOLDER TOP 1COLOUR SCALE 1	1-colored	300	-	1	054555*
HOLDER TOP 1COLOUR SCALE 2	1-colored	600	-	1	054561*
HOLDER TOP 1COLOUR SCALE 3	1-colored	1050	-	1	054567*
NUMBERPLATE HOLDER TOP 2C	2-colored	150	-	1	054377*
HOLDER TOP 1COLOUR SCALE 1	2-colored	300	-	1	054556*
HOLDER TOP 2COLOUR SCALE 2	2-colored	600	-	1	054562*
HOLDER TOP 2COLOUR SCALE 3	2-colored	1050	-	1	054568*
NUMBERPLATE HOLDER TOP 3C	3-colored	150	-	1	054378*
HOLDER TOP 3COLOUR SCALE 1	3-colored	300	-	1	054557*
HOLDER TOP 3COLOUR SCALE 2	3-colored	600	-	1	054563*
HOLDER TOP 3COLOUR SCALE 3	3-colored	1050	-	1	054570*
NUMBERPLATE HOLDER TOP 4C	4-colored	150	-	1	054379*
HOLDER TOP 4COLOUR SCALE 1	4-colored	300	-	1	054558*
HOLDER TOP 4COLOUR SCALE 2	4-colored	600	-	1	054564*
HOLDER TOP 4COLOUR SCALE 3	4-colored	1050	-	1	054571*

AGR: 16.540

License Plate Holder Stainless Steel

- Exclusive design
- No chromed or painted plastic, but
 - chromed stainless steel version of the edges

Title	Content	PU Piece	Article No.
HOLDER PREMIUM STAINLESS STEEL	1	1	054625

AGR: 16.540

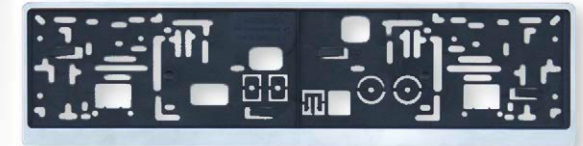
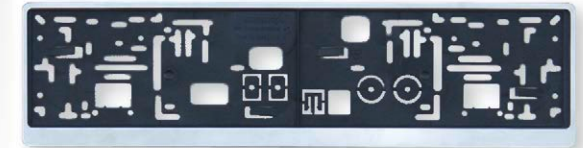

PB Prime Base Plate

Title	PU Piece	Article No.
PB Prime Base Plate	1/200/600/ 1000	340795

AGR: 16.540



PB Strip Silk Mat

Title	PU Piece	Article No.
PB Strip Silk Mat	200/600/ 1000	340796*

AGR: 16.540



PB Strip Silk Hexagon

Title	PU Piece	Article No.
PB Strip Silk Hexagon	200/600/ 1000	340797*

AGR: 16.540



INTERNAL/Approved (2019-03-23 01:04:31)

PB Strip Silk Hexagon

Title	PU Piece	Article No.
PB Strip Silk Hexagon	200/600/ 1000	340798*

AGR: 16.540

PB Strip Silk Carbon

Title	PU Piece	Article No.
PB Strip Silk Carbon	200/600/ 1000	340799*

AGR: 16.540

PB Strip Berner Carbon

Title	PU Piece	Article No.
PB Strip Berner Carbon	1	341051

AGR: 16.540



License Plate Holder

Processing Information

- Particularly suitable for interchangeable number plates

Hints

- Available with a screen printing or an epoxy resin coating

Technical Data

Ultra Violet Resistance Yes

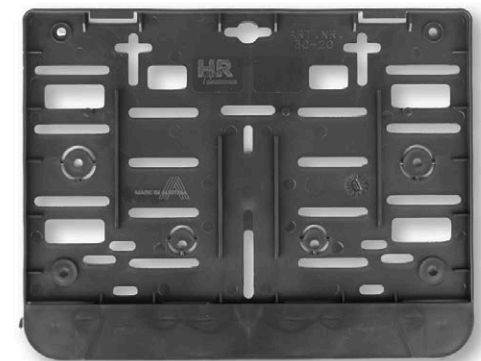
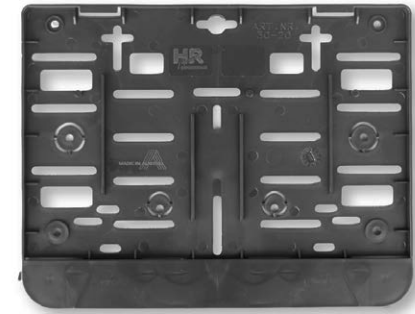

Title	Printing	Content	PU Piece	Article No.
NO.PLTE HOLD.2LIN.NEUTR.HGV/PK	(Translation missing)	1	1	175738
HOLDER 2LINE 1COLOUR SCALE 1	1-colored	100	1	054587*
HOLDER 2LINE 1COLOUR SCALE 2	1-colored	200	1	054594*
HOLDER 2LINE 2COLOUR SCALE 1	2-colored	100	1	054588*
HOLDER 2LINE 2COLOUR SCALE 2	2-colored	200	1	054595*
HOLDER 2LINE 3COLOUR SCALE 1	3-colored	100	1	054589*
HOLDER 2LINE 3COLOUR SCALE 2	3-colored	200	1	054596*
HOLDER 2LINE 4COLOUR SCALE 1	4-colored	100	1	054590*
HOLDER 2LINE 4COLOUR SCALE 2	4-colored	200	1	054597*

AGR: 16.540

Numberplate Holder for Motor Cycle

- Special spring elements provide a fast ejection of the vehicle registration number

Characteristics

- For motorcycle registration plates 210 x 170 mm

Processing Information

- Particularly suitable for interchangeable number plates

Hints

- Available with a screen printing or an epoxy resin coating

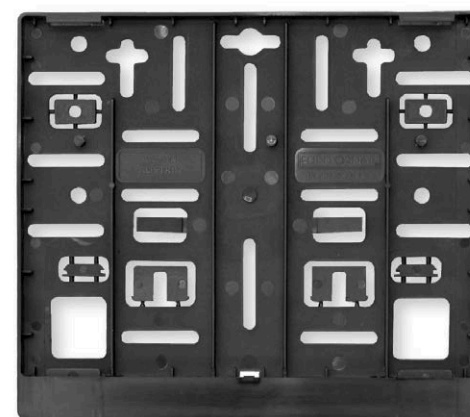
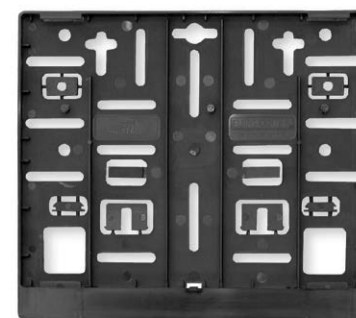

Title	Printing	Content	Color	PU Piece	Article No.
NO.PL.HOLD.NEW.F.MOT.CYCLE	(Translation missing)	1	black	1	024202
HOLD.MOTORBIKE 1COLOUR SCALE1	1-colored	100	-	1	054574*
HOLD.MOTORBIKE 1COLOUR SCALE2	1-colored	200	-	1	054581*
HOLD.MOTORBIKE 2COLOUR SCALE1	2-colored	100	-	1	054575*
HOLD.MOTORBIKE 2COLOUR SCALE2	2-colored	200	-	1	054582*
HOLD.MOTORBIKE 3COLOUR SCALE1	3-colored	100	-	1	054576*
HOLD.MOTORBIKE 3COLOUR SCALE2	3-colored	200	-	1	054583*
HOLD.MOTORBIKE 4COLOUR SCALE1	4-colored	100	-	1	054578*
HOLD.MOTORBIKE 4COLOUR SCALE2	4-colored	200	-	1	054584*

AGR: 16.540

Tarpaulin tensioning belts

Application Area

- Fixation of truck tarpaulins

Technical Data

Material Stainless Steel



Title	Length	Width	PU Piece	Article No.
DIREKT BUCKLE 31.0048.20	-	-	1	060137
FIXING PLATE 31:2428:20	-	-	100	059868
Belt Strap single	650 mm	45 mm	1	014257
TARPAULIN CLAMPING BELT 45MM	650 mm	45 mm	1	014190
TARPAULIN CLAMPING BELT 45MM	650 mm	45 mm	1	014191

AGR: 08.900

Canvas Cramp A

Application Area

- Fixing of truck canvases

Characteristics

- Zinc-plated, for round eyelets 36 and 40 mm, for oval eyelets 40 x 10 mm and 42 x 22 mm, for slotted eyelets 38 x 8 mm

Technical Data

Material	Steel zinc plated
Surface protection	ZP
Type, Bracket/Sprigs_01	for oval eyes 40x10 mm and 42x22 mm
Type, Bracket/Sprigs_02	for slot eyes 38x8 mm
Type, Bracket/Sprigs_03	for round eyes 36 mm and 40 mm

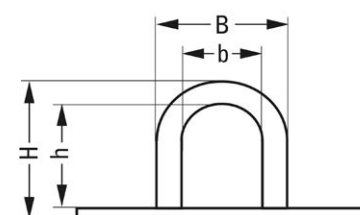
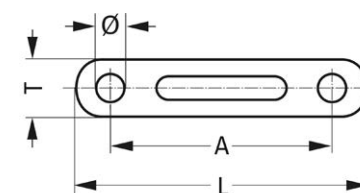

Title	Clear Height (H) In Mm	Total Height	Clear Width (B) In Mm	Width	Length	Depth	Hole Distance (A) In Mm	Bef-Hole Diameter	PU Piece
Canvas Cramps A PZ 20/25	25 mm	33 mm	20 mm	32 mm	71 mm	20 mm	51 mm	5 mm	25
Canvas Cramps A PZ 20/30	30 mm	38 mm	20 mm	32 mm	71 mm	20 mm	51 mm	5 mm	25
Canvas Cramps A PZ 20/40	38 mm	46 mm	20 mm	32 mm	71 mm	20 mm	51 mm	5 mm	25

Article No.

366242

366250

366269

AGR: 16.610

Sling swivel

Application Area

- Truck-tarpaulin securing

Characteristics

- Galvanzides, for oval rings 40 x 10 mm and 42 x 22 mm, for slit grommets 38 x 8 mm

Technical Data

Material	Steel zinc plated
Surface protection	ZP
Type, Bracket/Sprigs_01	for oval eyes 40x10 mm and 42x22 mm
Type, Bracket/Sprigs_02	for slot eyes 38x8 mm

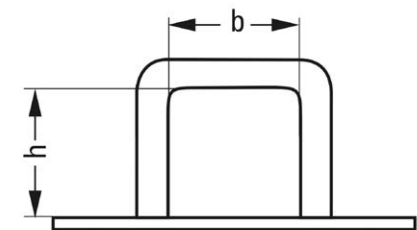
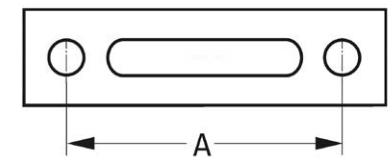
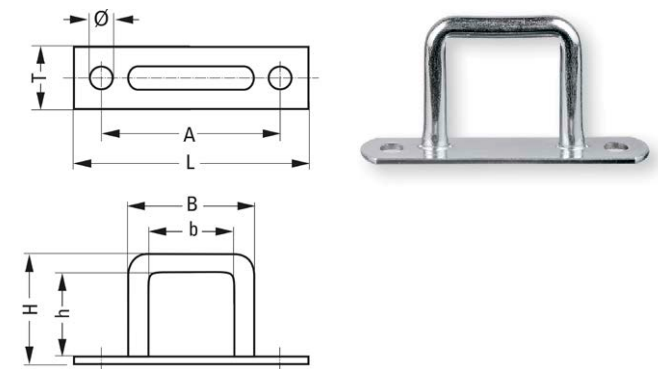

Title	Clear Height (H) In Mm	Total Height	Clear Width (B) In Mm	Width	Length	Depth	Hole Distance (A) In Mm	Hef-Hole Diameter	PU Piece
PZ 10/30GRBELT PROTECTOR	30 mm	36 mm	26 mm	36.5 mm	66 mm	15 mm	51 mm	5 mm	25

Article No.

110340

AGR: 16.610

INTERNAL/Approved (2019-03-23 01:05:31)

Folding clamp

Application Area

- Truck-tarpaulin securing

Characteristics

- Galvanized, according to custom regulations, with a pressed on counter plate and holes für countersunk screws, for round eyelets
- 36 and 40 mm, for oval rings 42 x 22 mm

Technical Data

Material	Steel zinc plated
Surface protection	ZP
Type, Bracket/Sprigs_01	for round eyes 36 mm and 40 mm
Type, Bracket/Sprigs_02	for oval eyes 42x22mm

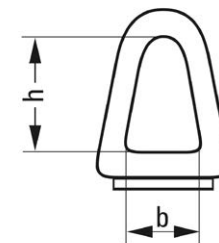
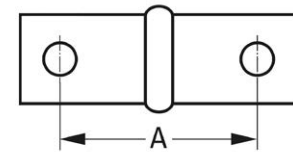
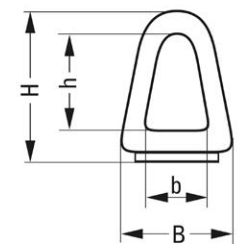
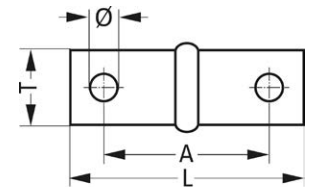

INTERNAL/Approved (2019-03-23 01:05:46)

Title	Clear Height (H) In Mm	Total Height	Clear Width (B) In Mm	Width	Length	Depth	Hole Distance (A) In Mm	Bef-Hole Diameter	PU Piece	Article No.
-------	------------------------	--------------	-----------------------	-------	--------	-------	-------------------------	-------------------	----------	-------------

Turn Lock

Application Area

- Fixing of truck canvases

Characteristics

- Zinc-plated, with stainless steel spring, for oval eyelets 42 x 22 mm

Technical Data

Material	Steel zinc plated
Surface protection	ZP
Type, Bracket/Sprigs_01	for oval eyes 42x22mm

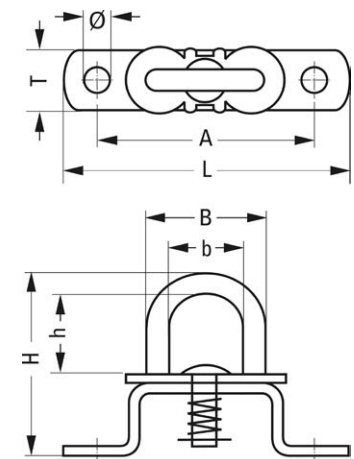

Title	Clear Height (H) In Mm	Total Height	Clear Width (B) In Mm	Width	Length	Depth	Hole Distance (A) In Mm	Bef-Hole Diameter	PU Piece	Article No.
Turn Lock	17 mm	45.5 mm	17.5 mm	29 mm	66 mm	15 mm	51 mm	5.5 mm	25	366277

AGR: 16.610

Ring Hook

Application Area

- Fixing of truck canvases

Characteristics

- Hot-dip galvanized, with bore holes for countersunk screws

Technical Data

Material	Steel
Surface protection	hot dip galvanized

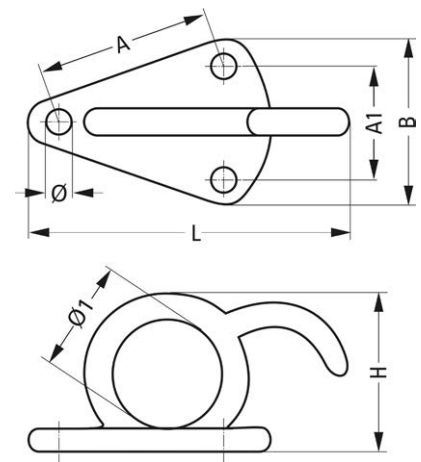

Title	Total Height	Width	Length	Hole Distance (A) In Mm	Hole Distance (A1) In Mm	Bef-Hole Diameter	Implementation-Ø (Ø1)	PU Piece	Article No.
Ring Hook	31 mm	45 mm	69 mm	34 mm	31 mm	5.3 mm	19 mm	25	366390

AGR: 16.611

Three Hole Canvas Hook

Application Area

- Fixing of truck canvases up to a rope diameter of 9 mm

Characteristics

- Hot-dip galvanized, small version, with bore holes for countersunk screws

Technical Data

Material	Steel
Surface protection	hot dip galvanized

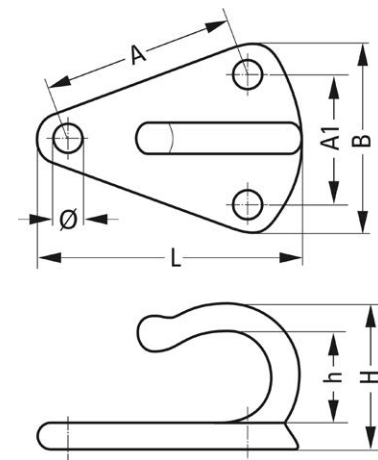

Title	Clear Height (H) In Mm	Total Height	Width	Length	Hole Distance (A) In Mm	Hole Distance (A1) In Mm	Bef-Hole Diameter	PU Piece	Article No.
Three Hole Canvas Hook	13 mm	24.5 mm	40 mm	50 mm	34 mm	28 mm	5.3 mm	25	110342

AGR: 16.611

Buckle Straps

Application Area

- Fixing of truck canvases

Characteristics

- With welded roller buckle, plastic, beige

Technical Data

Material	Plastic
----------	---------



Title	Length	Width	Hole Distance (A) In Mm	PU Piece	Article No.
Buckle Strap PZ 101	300 mm	20 mm	22 mm	25	366587

AGR: 16.614

Rubber Clamping Ring

Application Area

- Fixing of truck canvases

Characteristics

- Color: black



Title	Length	Material Thickness-Ø	PU Piece	Article No.
Rubber clamping Ring PZ 160	200 mm	8 mm	25	366706
Rubber clamping Ring PZ 160	250 mm	8 mm	25	366714

AGR: 16.619

Rubber tension ring with S-hook

Application Area

- Transport network fastening
Truck-tarpaulin securing

Characteristics

- Color black

Title	Length	Material Thickness-Ø	PU Piece	Article No.
TENSION RING WITH CLAMP 8X200	200 mm	8 mm	25	106795

AGR: 16.619



Customs-Approved PVC Strap

Application Area

- Fixing of truck canvases

Characteristics

- PVC with fabric underlayer

Processing Information

- Customs-No. III B2-Z 1209-4/73

Technical Data

Material Polyvinyl Chloride (PVC)

Title	Length	Width	Lace-Strenght (A)	PU Roll	Article No.
Customs-Approved PVC Strap PZ 130	50 m	24 mm	3 mm	1	366625

AGR: 16.614



Customs-Approved Canvas Rope with Steel Core

Application Area

- Fixing of truck canvases

Characteristics

- With TIR steel wire
- color: transparent



Title	Rope Length	Diameter (D) In Mm	Color	PU Amount	Article No.
Cust. Rope w. Steel Inlet	100 m	8 mm	Transparent	1	366463
TARPAUL.CBL INCH 6MM 250M-RL	250 m	6 mm	Transparent	1	167251
Customs-Approved Rope with Steel Core	250 m	8 mm	Transparent	1	366471

AGR: 16.612

Expander Rope

Application Area

- Fixing of truck canvases

Characteristics

- Rubber version
- color: gray



Technical Data

Material	Rubber
----------	--------

Title	Rope Length	Diameter (D) In Mm	Color	PU Ring	Article No.
Expander Rope	100 m	8 mm	Grey	1	110350

AGR: 16.612

Round Eyelets

Application Area

- Repair of Canvasses

Characteristics

- According DIN 7322, zinc-plated

Technical Data

Type, Eyes	Round
Material	Zinc plated

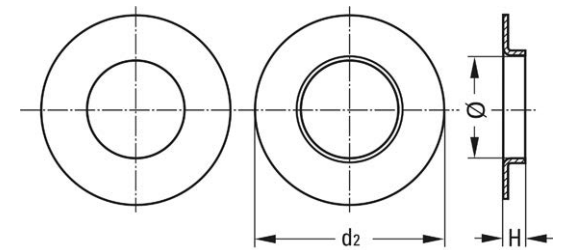

Title	Diameter Internal	Ø external	Height	PU Piece	Article No.
Round Eyelets	20 mm	36 mm	9.4 mm	25	110344
Round Eyelets	25 mm	44 mm	11.3 mm	25	366480
Round Eyelets	40 mm	62 mm	13 mm	25	366501

AGR: 16.613

Plastic Washer for Round Eyelets

Application Area

- Repair of Canvases

Characteristics

- High-pressure polyethylene
- color: transparent

Technical Data

Type, Eyes	Round
Material	Plastic
Color	Transparent

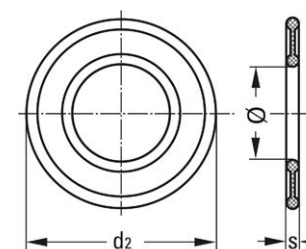

Title	Diameter Internal	Ø external	Height	PU Piece	Article No.
Plastic Washer	20 mm	37.8 mm	1.5 mm	25	110335

AGR: 16.619

Round Hollow Punch

Application Area

- Perforation of canvass, rubber, cardboard, leather for round eyelets

Characteristics

- Stable metal version



Title	Internal Ø (Opening Of Eyelet)	PU Piece	Article No.
Hollow Punch	20 mm	1	110347
Hollow Punch	25 mm	1	366749
Hollow Punch	36 mm	1	366757

AGR: 16.616

Round Piercing Punch

Application Area

- For round eyelets

Characteristics

- Stable metal version



Title	Internal Ø (Opening Of Eyelet)	PU Piece	Article No.
Round Piercing Punch	20 mm	1	110349

AGR: 16.617

Oval Eyelets

Application Area

- Repair of Canvases

Characteristics

- Zinc-plated

Technical Data

Type, Eyes Oval

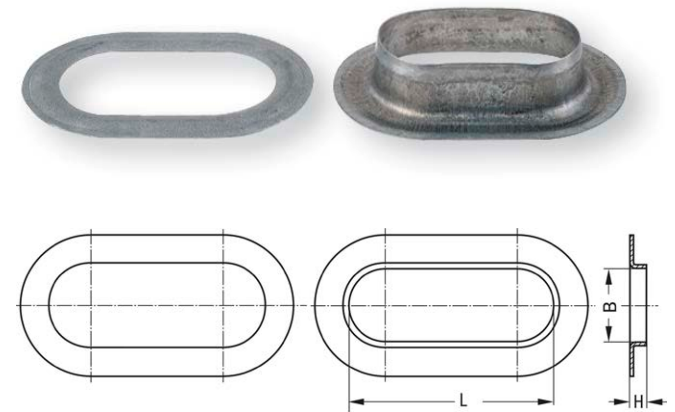

Title	Internal Length (A) In Mm	Width inside	Height	Material	PU Piece	Article No.
EYELET OVAL BRASS 42X22 MM	42 mm	22 mm	13 mm	Brass	25	139273
Oval Eyelets	42 mm	22 mm	13 mm	Zinc plated	25	366510

AGR: 16.613

Plastic Washer for Oval Eyelets

Application Area

- Repair of Canvases

Characteristics

- High-pressure polyethylene
- color: transparent

Technical Data

Type, Eyes	Oval
Color	Transparent

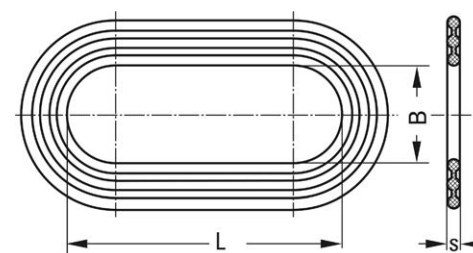

Title	Internal Length (A) In Mm	Width inside	Height	Material	PU Piece	Article No.
Plastic Washer	42 mm	22 mm	1.5 mm	Plastic	25	366560

AGR: 16.619

Slotted Exelets

Application Area

- Reparation of tarpaulins

Characteristics

- Broad design
- Galvanized

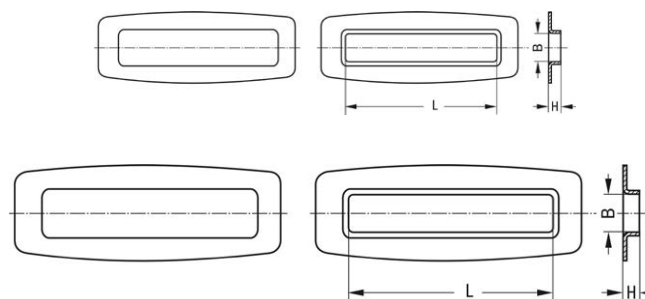

Title	Eyelet Opening, A	Eyelet Opening, B	Height	PU Piece	Article No.
PZ 92/39X7 SLOTTED EYEL.	38 mm	8 mm	10.3 mm	25	366528

AGR: 16.613

INTERNAL/Approved (2019-03-23 01:07:04)

Wide-Band Pressure Roller

Application Area

- Pressing on the canvas during repair



Title	PU Piece	Article No.
Wide-Band Pressure Roller	1	366846

AGR: 16.619

Patch for truck liner

- Special adhesive film for the immediate and permanent repair of truck and tarpaulins
- Easy to use, durable repairs for traveling
- There is no additional tools such as Hot air guns, brush or glue required



Application Area

- For the repair of damaged or cut plan and films

Processing Information

- Clean and dry the surface of dust, grease and oil Roll and cut tape length.
- RECOMMENDATION: round the corners with scissors into pieces of 5x5 mm
Pull silicone paper, place the tape accurate to the damaged area and press firmly.

Hints

- IMPORTANT: After applying the adhesive film can no longer be corrected and also very difficult to remove

Title	Length	Width	Color, Ral	PU Piece	Article No.
ROL.TARPAUL.REP.EASYPATCH BLAC	2500 mm	100 mm	Jet black	1	120470
ROL.TARPAUL.REP.EASYPATCH BLUE	2500 mm	100 mm	Ultramarine blue	1	120473
ROL.TARPAUL.REP.EASYPATCH GREE	2500 mm	100 mm	Opal green	1	120474
ROL.TARPAUL.REP.EASYPATCH GREY	2500 mm	100 mm	Agate grey	1	120471
ROL.TARPAUL.REP.EASYPATCH ORAN	2500 mm	100 mm	Deep orange	1	214827

Tarpaulin accessories

Title	Length	Width	Color, Ral	PU Piece	Article No.
ROL.TARPAUL.REP.EASYPATCH RED	2500 mm	100 mm	Carmin red	1	120472
ROL.TARPAUL.REP.EASYPATCH SILV	2500 mm	100 mm	White aluminium	1	214824
ROL.TARPAUL.REP.EASYPATCH WHIT	2500 mm	100 mm	Traffic white	1	120475
ROL.TARPAUL.REP.EASYPATCH YELL	2500 mm	100 mm	Signal yellow	1	214826

AGR: 16.690

Rope-End Locking Device with Simplex Hook

Application Area

- Fixing of truck canvas

Characteristics

- Zinc-plated for 8 mm ropes

Technical Data

Type, Hooks	Simplex hook
Material	Steel
Surface protection	zinc plated

Title	Length	PU Piece	Article No.
Rope End Locking Device with Simplex Hook	120 mm	25	366340

AGR: 16.612



Simplex Hook

Application Area

- Fixing of truck canvas

Characteristics

- Zinc-plated

Technical Data

Type, Hooks	Simplex hook
Material	Steel
Surface protection	zinc plated

Title	Length	PU Piece	Article No.
Simplex Hook	55 mm	25	366374

AGR: 16.611



Rope End Locking Device in Accordance with Customs Regulation (TIR)

Application Area

- Canvas Ropes

Characteristics

- Lead-sealing in accordance with TIR requirements
- rope end locking device: zinc-plated
- sleeve: brass
- rivet ping: aluminum



Title	Length	Wire Strength (S) In Mm	Internal Ø (Opening Of Eyelet)	PU Piece	Article No.
BRASS BUSHING FOR 6 MM-CABLE	-	-	-	25	168656
Sleeve, brass	-	-	8 mm	25	366366
Rivet Pin, aluminum	15 mm	-	-	25	366404
INCH-CAB.END.CONN 6 MM	70 mm	6 mm	-	25	167252
PZ51/8 CAB.END.INCH	70 mm	8 mm	-	25	366358

AGR: 16.612 / 16.615

Tool for cord end catch

- According to custom regulations
- Hardened tip

Application Area

- Cord end catch

Scope Of Delivery

- Bottom
- Holder for tip
- Beading stamp



Title	PU Piece	Article No.
TOOL.F.INCH CABLE END CL.6MM	1	175542

AGR: 16.619

Double Hook

Application Area

- Fixing of truck canvases

Characteristics

- Zinc-plated

Technical Data

Type, Hooks	Ramshorn hook
Material	Steel
Surface protection	zinc plated



Title	Length	Width	Thickness	PU Piece	Article No.
Double Hook	40 mm	11 mm	3.8 mm	25	200062

AGR: 16.611

Hollow rivets (double calott), flat head, steel zinc plated

Application Area

- Truck canvases

Characteristics

- Zinc-plated

Hints

- For blind rivets and rivet nuts, please see the chapter "DIN and Standard Parts"

Technical Data

Surface Protection, Shell	ZP zinc plated
---------------------------	----------------



Title	Husks Ø	Ø head	Length, Sleeve	PU Piece	Article No.
Hollow Rivets zi PZ 150/12	3 mm	13 mm	12 mm	100	366650

AGR: 16.615

INTERNAL/Approved (2019-03-23 01:07:51)

Clamping Lock Strap

Application Area

- Fast and safe rigging of goods at transport and stocking

Characteristics

- GS-approved, Lashing straps according to DIN EN 12195-2, reinforced PES-belt with small elongation, protected by rubbing and abrasion,
- gentle to surfaces, hard-wearing brand quality

Hints

- LC (lashing capacity) = allowed tensile force



Ratchet Lashing Strap, 1-piece

- Ratchet Lashing Strap, 1-piece

Application Area

- Ratchet Lashing Strap, 1-piece

Characteristics

- Ratchet Lashing Strap, 1-piece

Hints

- LC (lashing capacity) = allowed tensile force



Title	Permissible Traction Force (Direct Tension)	Permissible Carrying Capacity	Pre-Tensioning Force	Length (m)	Total Width	Color	PU Piece	Article No.
Ratchet Lashing Strap	250 daN	500 daN	-	4 m	25 mm	Blue	1	055408
Ratchet Lashing Strap	500 daN	1000 daN	-	4 m	25 mm	Orange	1	103415
Ratchet Lashing Strap	500 daN	1000 daN	190 daN	6 m	25 mm	Blue	1	055409
Ratchet Lashing Strap	1000 daN	2000 daN	240 daN	6 m	35 mm	Blue	1	055410
Ratchet Lashing Strap	2000 daN	4000 daN	300 daN	8 m	50 mm	Blue	1	055411
Ratchet Lashing Strap	2000 daN	4000 daN	300 daN	10 m	50 mm	Orange	1	109129

AGR: 08.900

Ratchet Lashing Strap with Twin Peak Hook, 2 Pieces

Application Area

- Fast and safe lashing of goods during transport and storage

Characteristics

- Solid end: 0.5 m,
- except for article no. 055413 (0.3 m)

Hints

- LC (lashing capacity) = LC value represents the force that the user can provide in direct lashing (e.g., 2500 daN)



- STF (Standard Tension Force) = pretension force = STF value represents the force that the user can apply to the loading area (for example, 400 daN) when pulling down the load (decisive for lashing)
- DaN = Deka Newton = unit of measure for force (10 Newtons = 1 daN = approx. 1 kg)
- Toning strips on the strap indicate the maximum pulling force of the lashing strap (LC), each strip being for 1 ton or 1,000 daN

Title	Permissible Traction Force (Direct Tension)	Permissible Carrying Capacity	Pre-Tensioning Force	Length (m)	Total Width	Color	PU Piece	Article No.
Ratchet Lashing Strap	500 daN	1000 daN	210 daN	6 m	25 mm	Blue	1	055412
Ratchet Lashing Strap	1000 daN	2000 daN	240 daN	6 m	35 mm	Blue	1	055413
Ratchet Lashing Strap	2000 daN	4000 daN	300 daN	8 m	50 mm	Blue	1/50/100/200	088614
Ratchet Lashing Strap	2000 daN	4000 daN	300 daN	9.5 m	50 mm	Blue	1	055415
Ratchet Lashing Strap	2500 daN	5000 daN	300 daN	8 m	50 mm	Blue	1	052370
Ratchet Lashing Strap	2500 daN	5000 daN	300 daN	10 m	50 mm	Blue	1	005498

AGR: 08.900

Ratchet Lashing Straps with Snap Hook, 2 Pieces

- Top over lashing is the most common method for cargo securing, mostly with straps
- For calculating the lashing expense, 5 points have to be identified and put into correlation: >softreturn/>1. STF-value of the ratchet (preload value, which is applied through the ratchet lever and strap onto the cargo)
 - ▶ 2. Coefficient of gliding (Can be raised through anti-slip mats)
 - ▶ 3. Lashing angle
 - ▶ 4. LC of the lashing point
 - ▶ 5. Weight of the cargo
- Three of these five points can be optimized and therefore the overall securing effort is being reduced

Application Area

- Fast and safe rigging of goods at transport and stocking

Characteristics

- Solid end: 0.5 mm



INTERNAL/Approved (2019-03-23 01:08:20)

Belts and round slings

- GS-approved, Lashing straps according to DIN EN 12195-2, reinforced PES-belt with small elongation, protected by rubbing and abrasion, gentle to surfaces, hard-wearing brand quality

Hints

- LC (lashing capacity) = LC-value stands for the strength, which the user produces during the direct lashing (e.g. 2500 daN)
- STF (Standard Tension Force) = preload force = Stf-value standce for the strength, which the user produces during the pull down (lashing) of the load onto the loading area (e.g. 400daN), crucial while down lashing
- daN = Deka Newton = measurement unit for force (10 Newton = 1 daN = approx. 1 kg)
- Tonnage strips on the strap clarify the maximum tensile force of the lashing strap (LC), every strap stands for 1 ton or 1.000 daN

Title	Permissible Traction Force (Direct Tension)	Permissible Carrying Capacity	Pre-Tensioning Force	Length (m)	Total Width	Color	PU Piece	Article No.
Ratchet Lashing Strap	500 daN	1000 daN	220 daN	6 m	25 mm	Blue	1	055418
Ratchet Lashing Strap	1000 daN	2000 daN	280 daN	6 m	35 mm	Orange	1	109130
Ratchet Lashing Strap	2000 daN	4000 daN	300 daN	8 m	50 mm	Blue	1	184455

AGR: 08.900

Ratchet Lashing Strap with Claw Hook, 2-part

- Top over lashing is the most common method for cargo securing, mostly with straps
- For calculating the lashing expense, 5 points have to be identified and put into correlation: >softreturn/>1. STF-value of the ratchet (preload value, which is applied through the ratchet lever and strap onto the cargo)
 - ▶ 2. Coefficient of gliding (Can be raised through anti-slip mats)
 - ▶ 3. Lashing angle
 - ▶ 4. LC of the lashing point
 - ▶ 5. Weight of the cargo
- Three of these five points can be optimized and therefore the overall securing effort is being reduced

Application Area

- Fast and safe rigging of goods at transport and stocking



Characteristics

- Fixed end: 0.5 m
- GS-approved, Lashing straps according to DIN EN 12195-2, reinforced PES-belt with small elongation, protected by rubbing and abrasion, gentle to surfaces, hard-wearing brand quality

Hints

- LC (lashing capacity) = allowed tensile force indicated the force, which the

Title	Permissible Traction Force (Direct Tension)	Permissible Carrying Capacity	Pre-Tensioning Force	Length (m)	Total Width	Color	PU Piece	Article No.
Ratchet Lashing Strap	2000 daN	4000 daN	300 daN	8 m	50 mm	Blue	1	109040

AGR: 08.900

Lashing Strap with Ratchet and Carabiner



Characteristics

- • Long arm ratchet - double preload force for
- effortless lashing

Title	Permissible Traction Force (Direct Tension)	Permissible Carrying Capacity	Pre-Tensioning Force	Length (m)	Total Width	Color	PU Piece	Article No.
Lashing Strap with Ratchet and Carabiner	2500 daN	5000 daN	500 daN	8 m	50 mm	Orange	1	006453
Lashing Strap with Ratchet and Carabiner	2500 daN	5000 daN	500 daN	10 m	50 mm	Orange	1	006447

AGR: 08.900

Ratchet Lashing Strap with long lever pull ratchet and double claw hook, 2-piece

- The same charge can be secured with less restraint straps
- Due to the longer ratchet lever and the high ratio the ratchets significantly higher biasing force value reached at the same handling as compared to pressure ratchets



INTERNAL/Approved (2019-03-23 01:08:28)

Belts and round slings

Application Area

- Fast and safe lashing of goods during transport and storage

Characteristics

- Scratch and abrasion resistant, strong translation thanks 4 tooth wheels, Optimized finger grip for easy handling, TÜV and GS Mark

Processing Information

- Top over lashing is the most common method for cargo securing, mostly with straps
- For calculating the lashing expense, 5 points have to be identified and put into correlation:
 1. STF-value of the ratchet (preload value, which is applied through the ratchet lever and strap onto the cargo)
 2. Coefficient of gliding (Can be raised through anti-slip mats)
 3. Lashing angle
 4. LC of the lashing point
 5. Weight of the cargo
- Three of these five points can be optimized and therefore the overall securing effort is being reduced



Hints

- LC (lashing capacity) = LC-value stands for the strength, which the user produces during the direct lashing (e.g. 2500 daN)
- STF (Standard Tension Force) = preload force = Stf-value standce for the strength, which the user produces during the pull down (lashing) of the load onto the loading area (e.g. 400daN), crucial while down lashing
- daN = Deka Newton = measurement unit for force (10 Newton = 1 daN = approx. 1 kg)
- Tonnage strips on the strap clarify the maximum tensile force of the lashing strap (LC), every strap stands for 1 ton or 1.000 daN

Title	Permissible Traction Force (Direct Tension)	Permissible Carrying Capacity	Pre-Tensioning Force	Length (m)	Total Width	Color	PU Piece	Article No.
Ratchet Lashing Strap	2500 daN	5000 daN	500 daN	8 m	50 mm	Blue	1/50/150	184448
Ratchet Lashing Strap	2500 daN	5000 daN	500 daN	10 m	50 mm	Blue	1/50/150	184450

AGR: 08.900

Lashing Strap

- Two-stage opening of the ratchet
- No danger through sliding or tipping cargo
- No risk of injury through the so called whip effect, because the belt tension is released under control when the ratchet is released
- The ratchet is immediately ready again due to the the automatic resetting

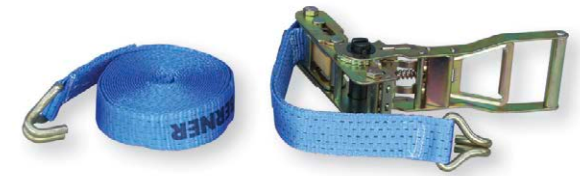

Application Area

- For cargo, which is in risk of tipping or danger of slipping

Characteristics

- If there is danger of sliding or tipping while opening, the 2step-ratchet can be tensioned again
- If the cargo is not in danger of sliding or tipping, the cargo can be released as usual with the second opening stage

Title	Permissible Traction Force (Direct Tension)	Permissible Carrying Capacity	Pre-Tensioning Force	Length (m)	Total Width	Color	PU Piece	Article No.
Ratchet Lashing Strap	2500 daN	5000 daN	500 daN	8 m	50 mm	Blue	1	082147

AGR: 08.900

Lashing Strap

- Weight reduction in comparison to the lashing chain
- Lower acquisition costs
- Easy handling through textile lashing strap, fast and comfortable, but not at the expense of the quality
- The lashing strap is 5.3 mm thick and extremely wear-resistant



Application Area

- Heavy load securing for lashing straps

Hints

- Only use heavy load lashing straps for diagonal lashing and no specification of the STF on the label

Title	Permissible Traction Force (Direct Tension)	Permissible Carrying Capacity	Length (m)	Total Width	Color	PU Piece	Article No.
Ratchet Lashing Strap	5000 daN	10000 daN	4 m	50 mm	Red	1	082153

AGR: 08.900

INTERNAL/Approved (2019-03-23 01:08:56)

Car Lashing Strap with Rubber Hose

Application Area

- Simple way of securing of cars through the rubber hose

Characteristics

- High strengthened polyester, covered with low elongation, wear and abrasion-resistant, surface protection, according to EN 12195-2



Title	Permissible Traction Force (Direct Tension)	Pre-Tensioning Force	Length (m)	Total Width	Color	PU Piece	Article No.
Car Lashing Strap with Rubber Hose	1500 daN	300 daN	2.6 m	35 mm	Blue	1	082627

AGR: 08.900

Ratchet lashing strap with overcenter lock and strapping rail fitting

Application Area

- For load securing in combination with a strapping rail - these are fix mounted on the structure (especially for gardening, food trade, and so on)



Title	Permissible Traction Force (Direct Tension)	Permissible Carrying Capacity	Length (m)	Total Width	Color	PU Piece	Article No.
Ratchet lashing with overcenter lock	750 daN	1500 daN	3 m	45 mm	Blue	1	006460

AGR: 08.900

Loose end with double claw hook



Title	Permissible Traction Force (Direct Tension)	Permissible Carrying Capacity	Length (m)	Total Width	Color	PU Piece	Article No.
Loose end	2500 daN	5000 daN	7.5 m	50 mm	Blue	1	184452

AGR: 08.900

Automatic Lashing Strap

- Automatic lashing strap with ratchet function similar to the seat belt in a car
- Fast, efficient and secure fixation
- Consuming knots, entanglements and loose components are avoided as the automatic lashing strap is retractable when not in use
- Hooks made of cast rubber significantly reduces the risk scratches during use
- By simply pressing the red button you are ensured a quick and easy storage without spare parts since the strap automatically retracts



Application Area

- Fast and secure fixation of goods during transportation and in storage

Hints

- According to EN 12195-2

Title	Permissible Traction Force (Direct Tension)	Permissible Carrying Capacity	Pre-Tensioning Force	Length (m)	Total Width	Color	PU Piece	Article No.
Automatic lashing strap	250 daN	500 daN	25 daN	3 m	25 mm	black	1	111724
Automatic lashing strap	500 daN	1000 daN	75 daN	3 m	50 mm	black	1	111727

AGR: 08.900

Hoisting Slings

- Approved by the respective professional association for all modes of assembly
- Color-coded according to bearing capacity
- Additionally woven-in tons straps for optimal safety

Application Area

- Lifting and securing of goods and tools

Characteristics

- Durable polyester (PES) belt loops with additionally reinforced end straps, safety factor 7:1, GS-tested (Safety Tested) according to EN 1492-1, CE mark, German brand quality



Title	Permitted tensile force	Permissible Carrying Capacity(U-Shape)	Length (m)	Total Width	Color	PU Piece	Article No.
Hoisting Slings	1000 daN	2000 daN	2 m	30 mm	Purple	1	055421
Hoisting Slings	1000 daN	2000 daN	3 m	30 mm	Purple	1	109124
Hoisting Slings	1000 daN	2000 daN	4 m	30 mm	Purple	1	055422
Hoisting Slings	1000 daN	2000 daN	5 m	30 mm	Purple	1	109119
Hoisting Slings	1000 daN	2000 daN	6 m	30 mm	Purple	1	200841
Hoisting Slings	2000 daN	4000 daN	2 m	60 mm	Green	1	200842
Hoisting Slings	2000 daN	4000 daN	4 m	60 mm	Green	1	055423
Hoisting Slings	2000 daN	4000 daN	6 m	60 mm	Green	1	055425
Hoisting Slings	3000 daN	6000 daN	2 m	90 mm	Yellow	1	200843
Hoisting Slings	3000 daN	6000 daN	4 m	90 mm	Yellow	1	055424
Hoisting Slings	3000 daN	6000 daN	6 m	90 mm	Yellow	1	055426

AGR: 08.900 / 08.901

Round Slings

- Impregnated and wear-resistant protective shell for an enhanced lifetime
- Color-coded according to load capacity
- Additionally woven-in tons straps and load capacity print for optimal safety

Application Area

- Hoisting and securing of goods and tools



Belts and round slings

Characteristics

- With single coat made of durable polyester (PES), safety factor of 7:1, GS-tested (Safety Tested) according to EN 1492-2, CE symbol, German brand quality

Hints

- The length indicated in the table is the perimeter. In order to obtain the usage dimension length L1, the perimeter is to be halved.

Title	Permitted tensile force	Permissible Carrying Capacity(U-Shape)	Useable Length	Length (m)	Color	PU Piece	Article No.
Round Sling	1000 daN	2000 daN	0.5 m	1 m	Purple	1	216420
Round Sling	1000 daN	2000 daN	1 m	2 m	Purple	1	055427
Round Sling	1000 daN	2000 daN	1.5 m	3 m	Purple	1	059612
Round Sling	1000 daN	2000 daN	2 m	4 m	Purple	1	055429
Round Sling	1000 daN	2000 daN	2.5 m	5 m	Purple	1	216421
Round Sling	1000 daN	2000 daN	3 m	6 m	Purple	1	200844
Round Sling	1000 daN	2000 daN	4 m	8 m	Purple	1	059611
Round Sling	2000 daN	4000 daN	0.5 m	1 m	Green	1	216422
Round Sling	2000 daN	4000 daN	1 m	2 m	Green	1	216419
Round Sling	2000 daN	4000 daN	1.5 m	3 m	Green	1	055428
Round Sling	2000 daN	4000 daN	2 m	4 m	Green	1	055430
Round Sling	2000 daN	4000 daN	2.5 m	5 m	Green	1	216418
Round Sling	2000 daN	4000 daN	3 m	6 m	Green	1	200845
Round Sling	2000 daN	4000 daN	4 m	8 m	Green	1	216417
Round Sling	3000 daN	6000 daN	0.5 m	1 m	Yellow	1	216416
Round Sling	3000 daN	6000 daN	1 m	2 m	Yellow	1	216415
Round Sling	3000 daN	6000 daN	1.5 m	3 m	Yellow	1	216414
Round Sling	3000 daN	6000 daN	2 m	4 m	Yellow	1	055431
Round Sling	3000 daN	6000 daN	2.5 m	5 m	Yellow	1	216413
Round Sling	3000 daN	6000 daN	3 m	6 m	Yellow	1	055432
Round Sling	3000 daN	6000 daN	4 m	8 m	Yellow	1	059691
Round Sling	4000 daN	8000 daN	1 m	2 m	Grey	1	216412
Round Sling	4000 daN	8000 daN	1.5 m	3 m	Grey	1	216411
Round Sling	4000 daN	8000 daN	2 m	4 m	Grey	1	216409
Round Sling	4000 daN	8000 daN	2.5 m	5 m	Grey	1	216408
Round Sling	4000 daN	8000 daN	3 m	6 m	Grey	1	216407

Title	Permitted tensile force	Permissible Carrying Capacity(U-Shape)	Useable Length	Length (m)	Color	PU Piece	Article No.
Round Sling	4000 daN	8000 daN	4 m	8 m	Grey	1	216405
Round Sling	4000 daN	8000 daN	5 m	10 m	Grey	1	216406

AGR: 08.901

Round Slings

- With an impregnated and abrasion-proof protective coat for a long lifetime
- Color-coded according to carrying capacity as well as additional woven tonnage stripes and a load capacity imprint



Characteristics

- • double coating out of resistant polyester(PES)
- • Safety factor 7:1, GS-sign, CE-sign
- • according to DIN V 61360

Title	Permitted tensile force	Permissible Carrying Capacity(U-Shape)	Useable Length	Length (m)	Color	PU Piece	Article No.
Round Slings	1000 daN	2000 daN	1 m	2 m	Purple [2]	1	151799
Round Slings	1000 daN	2000 daN	1.5 m	3 m	Purple [2]	1	109125
Round Slings	1000 daN	2000 daN	2 m	4 m	Purple [2]	1	151800
Round Slings	2000 daN	4000 daN	2 m	4 m	Green	1	151801
Round Slings	2000 daN	4000 daN	3 m	6 m	Green	1	151802
Round Slings	3000 daN	6000 daN	2 m	4 m	Yellow	1	109031
Round Slings	3000 daN	6000 daN	3 m	6 m	Yellow	1	151803
Round Slings	3000 daN	6000 daN	4 m	8 m	Yellow	1	151804

AGR: 08.901

One Way Round Sling

Characteristics

- Safety factor 1 : 5,
- Minimum breaking force is equivalent to the quintuple load capacity

Hints

- Color of sling 500 mm black
- Color of sling 1000 mm white
- Color may slightly differ from the picture

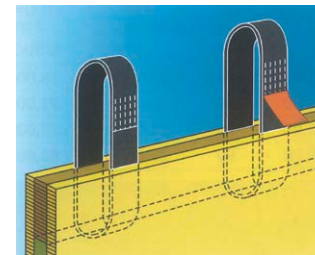

Title	Permissible Carrying Capacity (Sling)	Total Width	Color	PU Piece	Article No.
One Way Round Sling	730 daN	50 mm	black	90	151654
One Way Round Sling	1400 daN	50 mm	White	100	248620

AGR: 08.901

Edge Protector

- Protective hose from PVC-coated tissue material

Application Area

- Protects the tension belt from rubbing



Title	Length	Length x width	External Width	PU Piece	Article No.
EDGE PROTECTOR CT 50 AGR: 08.900	500 mm	500 x 50 mm	50 mm	1	109122

INTERNAL/Approved (2019-03-23 01:10:04)

Strip Protector

- Protection of the corners against large cargo of various size and quality
- Suitable for different forms of load
- Specially tested rubber coating
- Resistent against deformation and low or high temperature fluctuations
- Strap schooner PPCA with item number 248602, has a special cut in the middle of the strap. This enables attaching the strap to a pre-existing one.



Title	Length x total width	Color	PU Piece	Article No.
Edge Protection Profile	100 x 290 mm	black	1	248601
Edge Protection Profile	100 x 290 mm	black	1	248602

AGR: 08.900

Transport Belt Block

- For a fully stable mounting of the cargo
- No deformation through high or low outside temperatures
- Resists against a pressure of a few hundred kilograms



Title	Length x total width	Color	PU Piece	Article No.
Edge Protection Profile	40 x 100 mm	black	1	248600

AGR: 08.900

Edge Protection Profile

- Reliable protection of lashing straps or bundling ties
- Distribution of the clamping pressure in a beneficial ratio through wide surface
- Withstands a pressure of hundreds of kilogram
- Resistant against all weather conditions
- Lateral stop prevents shifting of the strap

Application Area

- Perfect edge securing for all kind of sensitive and fragile transported goods
- for smaller loads
- Special form for a better protection of the edges of the cargo



INTERNAL/Approved (2019-03-23 01:10:20)

Title	Length x total width	Color	PU Piece	Article No.
-------	----------------------	-------	----------	-------------

Edge Protection Profile

- Reliable protection of lashing straps or bundling ties
- Distribution of the clamping pressure in a beneficial ratio through wide surface
- Lateral stop prevents shifting of the strap
- CE-certified
- Break-proof

Application Area

- Perfect edge securing for all kind of sensitive and fragile transported goods

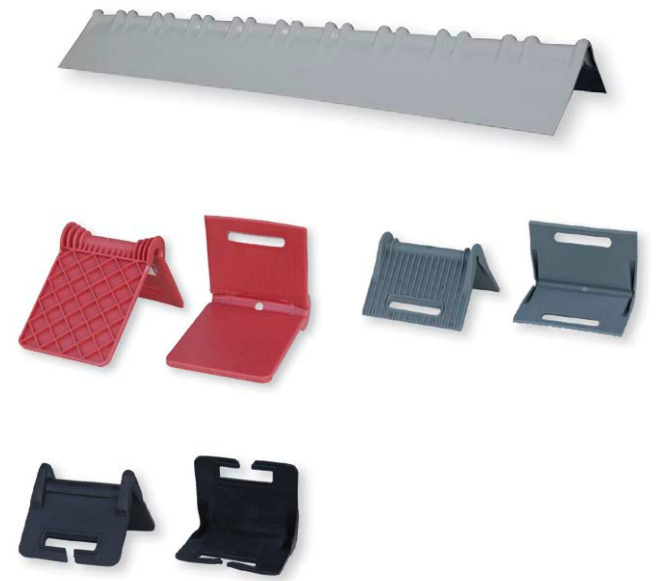

Title	Length x total width	Color	PU Piece	Article No.
Edge Protection Profile AGR: 08.900	175 x 1200 mm	White	1	248604

Edge Protection Profile

- Reliable protection of lashing straps or bundling ties
- Distribution of the clamping pressure in a beneficial ratio through wide surface
- break-proof
- Lateral stop prevents shifting of the strap
- Resistant against all weather conditions

Application Area

- Perfect edge securing for all kind of sensitive and fragile transported goods
- Especially suitable for smaller loads



Title	Length x total width	Color	PU Piece	Article No.
Edge Protection Profile	100 x 130 mm	Red	1	248603
Edge Protection Profile	100 x 130 mm	black	1	248613

AGR: 08.900

Edge Protection Profile

- Reliable protection of lashing straps or bundling ties
- Distribution of the clamping pressure in a beneficial ratio through wide surface
- Protects the corners against cargo
- Break-proof
- Lateral stop prevents shifting of the strap
- Resistant against all weather conditions

Application Area

- Perfect edge securing for all kind of sensitive and fragile transported goods
- Edge protection protects especially the lashing strap and sensitive products. Not suitable for palletized cargo and bulk materials. Particularly suitable for sensitive products like rolled goods, barrels, plasterboard or chipboards
- Permanently resistant



Title	Length x total width	Color	PU Piece	Article No.
Edge Protection Profile AGR: 08.900	160 x 210 mm	black	1	248609

Edge Protection Profile

- Reliable protection of lashing straps or bundling ties
- Distribution of the clamping pressure in a beneficial ratio through wide surface
- Patented
- Ce certified for industry
- Lateral stop prevents shifting of the strap

Application Area

- Perfect edge securing for all kind of sensitive and fragile transported goods
- Edge protection protects especially the lashing strap and sensitive products. Not suitable for palletized cargo and bulk materials. Particularly suitable for sensitive products like rolled goods, barrels, plasterboard or chipboards
- Eco version of the edge protector KPDL



INTERNAL/Approved (2019-03-23 01:10:49)

Title	Length x total width	Color	PU Piece	Article No.
Edge Protection Profile	160 x 210 mm	Red	1	248607
Edge Protection Profile	160 x 210 mm	black	1	248608

AGR: 08.900

Edge Protection Profile

- Reliable protection of lashing straps or bundling ties
- Distribution of the clamping pressure in a beneficial ratio through wide surface
- Withstands a load of hundreds of kilogram
- Lateral stop prevents shifting of the strap

Application Area

- Perfect edge securing for all kind of sensitive and fragile transported goods

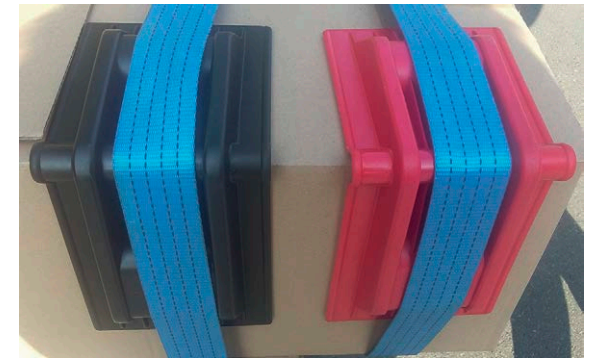

Title	Length x total width	Color	PU Piece	Article No.
Edge Protection Profile	160 x 230 mm	Red	1	248605
Edge Protection Profile	160 x 230 mm	black	1	248606

AGR: 08.900

Aluminum Clamping Bar

Application Area

- Securing of goods on the loading area
- Combination with barrier nets or frames

Characteristics

- Pipes made of high-quality aluminum with solid anti-slip rubber feet on both sides, stageless quick adjustment up to 15°, crepe rubber disks, safe release of the inclination of the pressed-on parts of spread mechanism

Title	Clamping range	Chain nominal thickness	PU Piece	Article No.
Clamping bar	2.26 - 2.63 m	38 mm	1	055434

AGR: 08.900



Partition Locking Device

Application Area

- Securing of goods at the platform gate

Characteristics

- Extractable aluminum profile with 2 locking devices



Title	Clamping range	PU Piece	Article No.
Partition Locking Device	2.40 - 2.70 m	1	055433

AGR: 08.900

Lashing Chain with Separate Tensioning Chain

Application Area

- Securing of heavy loads

Characteristics

- Ratched load clamping fixture with separate chain, quality class 8, reliable traction force (daN) with direct traction, manufactured in accordance with DIN EN 12195-3



Title	Permitted tensile force	Length total (mm)	Chain nominal thickness	Tension Distance	Tensioner Closed	PU Piece	Article No.
Lashing Chain	6300 daN	3500 mm	10 mm	140 mm	610 mm	1	055436*
Lashing Chain	4000 daN	3500 mm	8 mm	155 mm	560 mm	1	055435*

* = The delivery time is 35 days

AGR: 08.900

INTERNAL/Approved (2019-03-23 01:10:59)

Container Mesh

- Simple operation provides maximum security
- High quality of polypropylene multifilament (PPM) technology ensures long service life

Application Area

- Covering full containers, tipping containers and trucks



Title	Length x total width	Mesh Size	Chain nominal thickness	Color	PU Amount	Article No.
Container Net	5 x 3.5 m	45 mm	3 mm	Green	1	055439
Container Net	6 x 3.5 m	45 mm	3 mm	Green	1	167690
Container Net	7 x 3.5 m	45 mm	3 mm	Green	1	055440
Container Net	8 x 3.5 m	45 mm	3 mm	Green	1	201020

AGR: 08.900

Cover Nets for Transporters

- Easy usage
- High-quality polypropylene-multifilament (PPM) guarantees an enhanced lifetime
- Knotless version

Application Area

- Covering of loading areas where vans and car drawn trailers

Hints

- Without rubber border strip

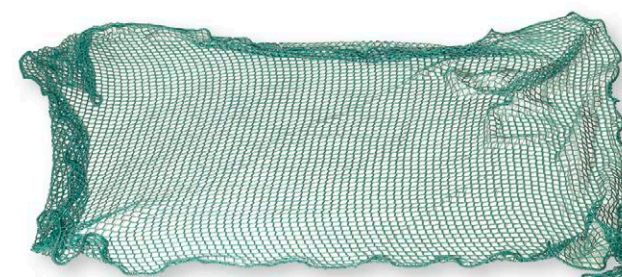

Title	Length x total width	Mesh Size	Chain nominal thickness	Color	PU Piece	Article No.
Cover Net for Transporters	2.5 x 3.5 m	35 mm	3 mm	Green	1	052957
Cover Net for Transporters	2.5 x 4 m	35 mm	3 mm	Green	1	052956
Cover Net for Transporters	2.5 x 4.5 m	35 mm	3 mm	Green	1	052958

AGR: 08.900

Expander Rope

Application Area

- Fixing of truck canvases

Characteristics

- Rubber version
- color: gray

Technical Data

Material	Rubber
----------	--------

Title	Rope Length	Diameter (D) In Mm	Color	PU Ring	Article No.
Expander Rope	100 m	8 mm	Grey	1	110350

AGR: 16.612



Ring Hook

Application Area

- Fixing of truck canvases

Characteristics

- Hot-dip galvanized, with bore holes for countersunk screws

Technical Data

Material	Steel
Surface protection	hot dip galvanized

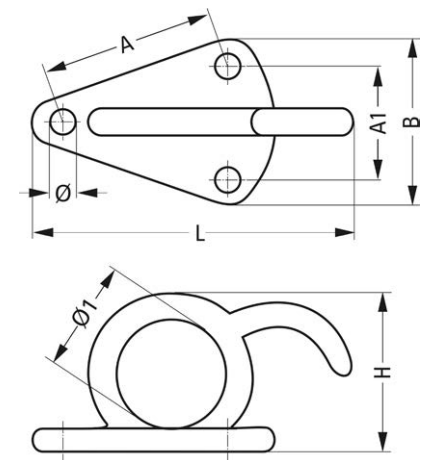

Title	Total Height	Width	Length	Hole Distance (A) In Mm	Hole Distance (A1) In Mm	Bef-Hole Diameter	Implementation-Ø (Ø1)	PU Piece	Article No.
Ring Hook	31 mm	45 mm	69 mm	34 mm	31 mm	5.3 mm	19 mm	25	366390

AGR: 16.611

Three Hole Canvas Hook

Application Area

- Fixing of truck canvases up to a rope diameter of 9 mm

Characteristics

- Hot-dip galvanized, small version, with bore holes for countersunk screws

Technical Data

Material	Steel
Surface protection	hot dip galvanized

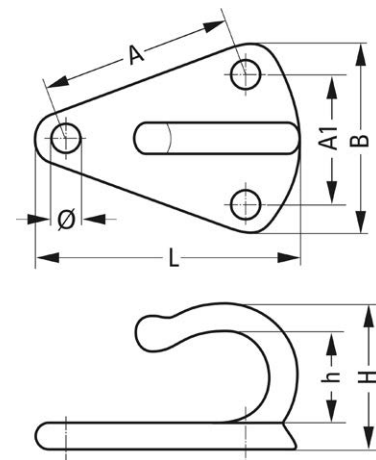

Title	Clear Height (H) In Mm	Total Height	Width	Length	Hole Distance (A) In Mm	Hole Distance (A1) In Mm	Bef-Hole Diameter	PU Piece	Article No.
Three Hole Canvas Hook	13 mm	24.5 mm	40 mm	50 mm	34 mm	28 mm	5.3 mm	25	110342

AGR: 16.611

Anti-Slip Mat

- Enhanced level of protection and safety thanks to anti-slip effect.
- Better stability and safety
- Individual formats by means of own cuttings
- Reduction of the required lashing material as well as of the approved traction force
- Multiply reusable

Characteristics

- Rubber granules with a special, non-slip surface
Grater value 0.6 μ



Title	Length x total width	Chain nominal thickness	Color	PU Roll	Article No.
Anti-Slip Mat	5000 x 250 mm	8 mm	black	1	055441

AGR: 08.900

Anti-Grind-Matt

- Due to the use of a anti-slip mat the friction coefficient between the material and the underfloor is increased, higher security during transportation
- less tension belts are needed
- sizes are matched with the sizes of transport pallets



Application Area

- Load securing
- Storage of smooth or slippery materials



Title	Length	External Width	Total height	Color	PU Piece	Article No.
Anti-Slip Mat 61x122 cm	1220 mm	610 mm	4 mm	black	1	124503
Anti-Slip Mat 91x122 cm	1220 mm	910 mm	4 mm	black	1	124501
Anti-Slip Mat 30x182 cm	1820 mm	300 mm	4 mm	black	1	124500
Anti-Slip Mat 45x182 cm	1820 mm	450 mm	4 mm	black	1	124502

AGR: 08.106

INTERNAL/Approved (2019-03-23 01:11:39)

Protection mat

- Well-suited to protect sensitive surfaces from damages
- Slip-resistant mat in the trunk
- Depositing of tools or materials on sensitive or lacquered surfaces
- No slipping of materials while repairing

Application Area

- Slip-resistant mat
- Place mat
- Transport lock
- Underlay for tools
- Covering



Title	Length x total width	Color	PU Piece	Article No.
Protection mat	900 x 610 mm	black	1	219197

AGR: 08.106

CORDSTRAP Strapping system

- Easy handling
- Particularly high tear resistance
- Retensionable
- No scratching or damaging of surfaces
- Extensibility and resilience of the straps absorb jolts
- Does not rust, weather-resistant and UV-resistant
- No risk of injury

Title	PU Amount	Article No.
CORDSTRAP-CLAMB CTT-20	1	059064
CORDSTRAP-CLIP 13MM 1000STK	1	059066
CORDSTRAP-DISPENSER CSD-76	1	059065
POLY. ENCOMP. BELT 13MM 1400LM	1	059067

AGR: 08.900



Truck Marking Boards ECE 70

Application Area

- Rear marking plates for heavy and long vehicles and trailers, i.e. trucks, tractors, trailers and semi-trailer/trailers
- In Germany, according to § 53 (10) no. 2 StVZO (with attachments) i. V. m. § 49a (7)
- Road Traffic Licensing Regulations allowed
- Required by ECE 70.00 in almost all other European countries

Characteristics

- Aluminum sheet 1.5 mm, admission E3
- Yellow: foil type 2 with registration number
- Red-orange: fluorescent film

Processing Information

- Optional 2 x half marks or 1 x full mark for each vehicle
- Can be mounted both horizontally and vertically

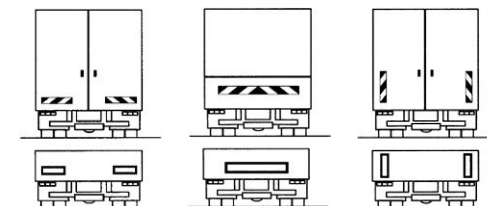

Title	Application Vehicle Type	Type, Warning Markings	Length	Width	PU Piece	Article No.
Full Marking Plates AGR: 16.934	Trailer	Full marking	1130 mm	200 mm	1	121203

INTERNAL/Approved (2019-03-23 01:12:03)

Kit truck und truck trailer panles

Application Area

- Rear marking plates for heavy and long vehicles and trailers, ie Trucks and tractors (motor vehicles)
- In Germany, according to § 53 (10) no. 2 StVZO (with attachments) i. V. m. § 49a (7) Road Traffic Licensing Regulations allowed
- Required by ECE 70.00 in almost all other European countries

Characteristics

- Aluminum sheet 1.5 mm, admission E3
- Yellow: foil type 2 with registration number
- Red-orange: fluorescent film

Processing Information

- Optional 2 x half marks or 1 x full mark for each vehicle
- Can be mounted both horizontally and vertically
- Red triangle must point upwards and outwards

Scope Of Delivery

- Set consisting of a right-looking and a left-looking half mark (one vehicle)

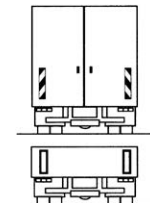
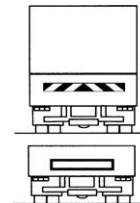
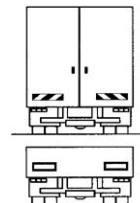

Title	Application Vehicle Type	Type, Warning Markings	Length	Width	PU Paar	Article No.
Semi-Marking Plates	Motor vehicles	Semi marking	565 mm	130 mm	1	117599

AGR: 16.934

Warning Signs for Loading Ramps

Application Area

- For the marking of loading ramps and similar vehicle components, also suitable in the case of a loading according to § 53 b (5) RTLR

Characteristics

- Film on flexible plastic with fixed aluminum holder
- Edge protection at the bottom, which also serves as a weight holder in two holes (Ø 6 mm) at a distance of 206 mm are included
- Foil type 2
- Temperature resistant and salt water resistant

Processing Information

- 1 x 1 x pointing right and left-setting per vehicle
- Red triangle must point upwards and outwards

Technical Data

Color red / white



Container Warning Marks, Foil, L/R in Set

Application Area

- Labeling of containers and swap containers which are placed in common traffic areas
- Road safety obligation according to § 32 (1) RTLR, as it is blocking traffic (additionally, a special permit granted by the road traffic office according to § 32 VwV RTLR 1 (III) is required).
- Proper labeling on traffic Gazette of 28.04.1982 and 11.01.1984

Characteristics

- Sensitive, flexible warning marking tape
Foil type 2 according to DIN 67520, Part 2 (reflection) and DIN 6171 Part 1 (color)
Back Printing for effective scratch and UV protection

Processing Information

- 4 x 4 x pointing right and left-setting per container
Red triangle must point upwards and outwards

Scope Of Delivery

- Set of 4 pretty looking and 4 left pointing films (a container)

Technical Data

Color	red / white
Norms	DIN 67520-2
Fastening Type	Self adhesive



Title	Type, Warning Markings	Length	Width	PU Set	Article No.
Container Warning Marks, Foil, L/R in Set	Full marking	705 mm	141 mm	1	161559

AGR: 16.934

Warning Mark Foil

Application Area

- According to DIN 30710



- Identification of vehicles used for the construction, maintenance or cleaning the streets and equipment for road space, or refuse collection and measurement vehicles the Regulatory Authority for Telecommunications and Posts accordance with § 35 (6) + (7) Highway Code, § 52 (4) no. 1 traffic regulations i. V. m. § 49a (7) with German and leaflets for winter service vehicles

Characteristics

- Sensitive, flexible and detachable warning marking tape on a roll
Foil type 2 according to DIN 67520, Part 2 (reflection) and DIN 6171 Part 1 (color)
Back Printing for effective scratch and UV protection

Processing Information

- The minimum requirement for each vehicle: Front and rear depending 141x1128 mm, connected at least 141x282 mm uncovered
A lateral identification is recommended for vehicle use transversely to the direction of travel
The strips must fall outwards

Technical Data

Fastening Type Self adhesive

Title	Application Vehicle Type	Type, Warning Markings	Length	Width	PU Piece	Article No.
Warning Mark Foil	Vehicles with special rights Winter service vehicles Municipal vehicles garbage truck Container	left-handed	9 m	141 mm	1	164762
Warning Mark Foil	Vehicles with special rights Winter service vehicles Municipal vehicles garbage truck Container	right-handed	9 m	141 mm	1	164761

AGR: 16.934



Warning Boards

Application Area

- Identification of road vehicles with extra wide / extra long or extra-wide / extra-long cargo according to § 32 StVZO in conjunction with § 22 (2) Highway Code and § 29 VwVStVO (Exemption: § 46 Highway Code, § 70 and 71 Road Traffic Regulations, § 49a (7) Road Traffic Licensing Regulations)



Characteristics

- Galvanized steel sheet 0.8 mm, beaded outer edges, right- or left-setting, reversible
- Glued foil type 1 according to DIN 11030

Processing Information

- Red triangle must be directed upwards/outwards

Technical Data

Norms DIN 11030

Title	Length	Width	PU Piece	Article No.
Warning Board	423 mm	423 mm	1	161393

AGR: 16.934

Dangerous Goods - Warning Sign

Application Area

- Identifying dangerous goods, in which dangerous goods (such as gasoline, heating oil, diesel) are transported in accordance with ADR Standard 5.3.2.

Characteristics

- Galvanized steel sheet 0.8 mm, vertically hinged with black edge trim and twist closure
Film type 1

Processing Information

- At the front and rear of the vehicle must have a single panel be mounted
Application: the front and rear

Scope Of Delivery

- Includes mounting hardware and spare screw cap



Title	Type, Warning Markings	Length	Width	PU Piece	Article No.
Dangerous Goods Warning Sign AGR: 16.934	Full marking	400 mm	300 mm	1	161398

Foldable Waste Sign

Application Area

- Identification of waste shipments where vehicles transporting hazardous waste and special waste on public roads, according to Recycling and Waste Management Act (KrW / Recycling Act)
- § 49 (6) for domestic shipments
- § 10 for cross-border transport

Characteristics

- Galvanized steel sheet 0.8 mm, vertically hinged with black edge trim and twist closure
- Film type 1

Processing Information

- One sign each is to be attached to front and rear

Scope Of Delivery

- With fixing material

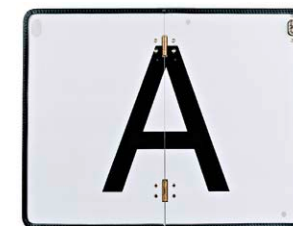

Title	Type, Warning Markings	Length	Width	PU Piece	Article No.
Folding Waste billboard	Full marking	400 mm	300 mm	1	161397

AGR: 16.934

Metal cap for fold-out plate



Title	PU Piece	Article No.
METAL CLOSURE F.FOLDING PANELS	1	167253

AGR: 16.934

Reflective Speed Limit Sign

- Enhanced visibility (even in the dark), thanks to reflectiveness according to DIN 75 069

Application Area

- Identification of the vehicle speed according to § 58 (2) StVZO
- For trucks and buses

Characteristics

- Foil type 2 with red border and black numbers, self-adhesive, Ø 200 mm

Technical Data

External-Ø	200 mm
Self Adhesive	Yes

Title	Indication Of Speed	PU Piece	Article No.
SPEED LIMIT STICKER 70KM	70 km/h	1	118883
Speed Limit Stickers	80 km/h	1	111905

AGR: 16.934



Retro reflective contour marking ECE-R 104

- The rear and the sides of the vehicle are defined clearly by contour markings and make it visible from a distance of 1000 meter. Therefore vehicles which have contour markings can be recognized up to 8-9 seconds earlier.
- Contour markings are sending visual hints to drivers, which helps to determine the size and speed of trucks
- The retroreflective film also provides an optimum of reflection when it is laterally illuminated, reflection even under wet conditions
- The structure of the surface is a rhombus or a honeycomb
- Very thin single-pass film - easily glueable on corners
- Resistant against petrol vapor and occasional spillages of fuels
- No damaging through water and high-pressure cleaners
- No separate sealing of the edges necessary
- All films are self-adhesive

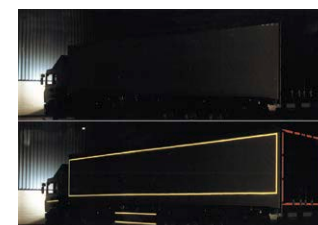

INTERNAL/Approved (2019-03-23 01:13:22)

Warning markings

Application Area

- Retro reflective contour marking is suitable for heavy and long motor vehicles and their trailers, trucks and vans according to ECE-rule number 104
- Application for fixed bodies and grounds

Hints

- From Juli 2011 all new trucks with a weight of 7.5 tonns or more and all new trailers with a weight of 3.5 tonns or more obligatorily have to have contour markings.
- Detailed instructions for a lawful and proper fixation as well as instructions for cleaning and mentainance included
- Do not use for tarpaulin superstructures

Title	Length	Width	Color	PU Roll	Article No.
REFL.ADH.STRIP.RED 12.5M	12.5 m	50 mm	Red	1	156815
REFL.ADH.STRIP.WHI 50M 50MM	50 m	50 mm	White	1	156814
REFL.ADH.STRIP.YELLOW 50M 50MM	50 m	50 mm	Yellow	1	156813

AGR: 12.474

Retro-Reflective Warning Foil ECE-R 104

- Very thin monolayer film - easily glued to corners
- Retroreflective sheeting (type 3) - optimum reflection even at oblique being illuminated and wet
- No separate sealing the edges necessary
- Very good visibility - increased traffic safety

Application Area

- Identification of heavy and long vehicles and their trailers, and of vans according to ECE-104 and ECE-48
- With ECE approval (E1) without special permission usable

Characteristics

- Self-adhesive, flexible film warning label on a roll
- Film type 3
- No damage from petrol fumes, occasional fuel splash, water and high-pressure cleaner

Processing Information

- Application to rigid surfaces and structures plan / tanker

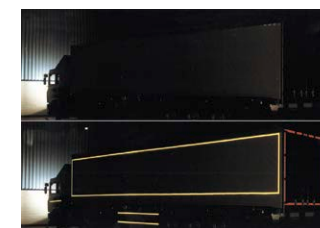

- Guidelines for the attachment of warning labels on next page



Title	Length	Width	Color	PU Piece	Article No.
Warn. for solid underground red	50 m	50 mm	Red	1	088338
Warn. for Canvas/Tank red	50 m	51 mm	Red	1	088342
Warn. for Canvas/Tank white	50 m	51 mm	-	1	088341
Warn. for Canvas/Tank yellow	50 m	51 mm	Yellow	1	088343

AGR: 12.474

Warnings Boards

Hints

- Warning board
This warning board indicates that dangerous goods are being transported. This could be various substances and risks, packed in different wrappings like barrels, canisters, cartons, boxes and so on. The rules and restrictions for combining items for shipping must be kept in any case.
- Vehicles, which carry a certain amount of goods which pose a risk for living beings, have to be clearly marked. The marking has to be done, so if there is an accident the rescue teams can take the right measures.



Technical Data

Norms DIN 30710

Title	Type, Warning Markings	Length	Width	PU Piece	Article No.
WARNING SIGN ORGE SHEET	Full marking	400 mm	300 mm	1	146584

AGR: 16.934

Low noise label/-table "L"

Hints

- This truck is not subject to the in Austria applicable night-time driving ban (special engine and noise encapsulation)

Technical Data

Fastening Type Self adhesive



Title	Width	PU Piece	Article No.
LOW NOISE STICKER"L"ALU	-	1	025411
LOW NOISE-STICKER L (FOR A)	200 mm	1	167220

AGR: 16.934

Route Approval Sticker

Hints

- Likewise marked vehicles have a route permit for a specific driving path, which is otherwise closed-off for trucks.



Title	PU Piece	Article No.
ROUTE APPROVAL-STICKER "R"	1	025405
AGR: 16.934		

Flatblade range UNIFLAT

- Resistant to cracking and UV degradation due to high wiper quality
- Asymmetric flexor and optimal fit to glass at all conditions
- The spoiler with variable geometry adjusts according to wind flow over the wiper. Therefore windlift effect is reduced and the wipe quality is enhanced
- Optimal water displacement also at high speed
- Fits all major connection systems: Federal Mogul, Bosch, Valeo
- Original Equipment (OE) technique incorporated
- Low stock investment and high stock turn for the garage
- Quality made in Europe

Application Area

- System for over 90% of current vehicle models on the market
- Fits directly onto the wiper arm for vehicles with flat blade wipers
- Can be converted for J-hook 9 x 9 x 3 and 4 mm for vehicles with conventional wiper bar (retrofit)

Hints

- All adapters supplied in packaging
- Application list can be downloaded in B.Com

Title	Length	Number Of Containing Adapters	PU Piece	Article No.
Flatblade EV350	350 mm	6	1	113274
Flatblade EV375	375 mm	6	1	113275
Flatblade EV425	425 mm	6	1	113277
Flatblade EV500	500 mm	7	1	113280
Flatblade EV550	550 mm	6	1	113284
Flatblade EV750	750 mm	6	1	113289

AGR: 16.200

Flat Blades for Passenger Cars

- Full width spoiler like OE blades for stability on long blades and better wipe performance
- New Master Connector System fits 7 arm types by using only 4 different connectors

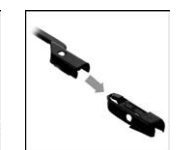
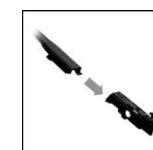
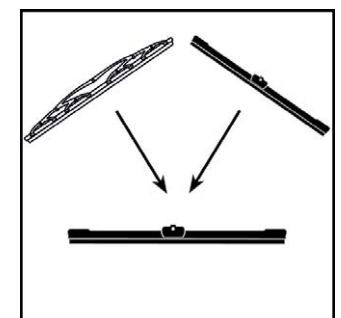

INTERNAL/Approved (2019-03-23 01:14:10)



Windscreen wipers

- Compact product range of all standard sizes for a small warehouse investment
- Due to asymmetrical bending, the wiper optimally adapts to the windshield
- Optimum water displacement even at high speeds
- Convertable to J-Hooks of cars with standard blades with Retrofit Adapter

Application Area

- Usable for all common systems like Federal Mogul, Champion, Bosch und Valeo
- Range delivers 95% model coverage of the current market

Hints

- All adapters are included



Title	Length	PU Piece	Article No.
Flat Blade	350 mm	1	338376
Flat Blade	380 mm	1	338375
Flat Blade	400 mm	1	338367
Flat Blade	430 mm	1	338366
Flat Blade	450 mm	1	338365
Flat Blade	480 mm	1	338364
Flat Blade	500 mm	1	338363
Flat Blade	530 mm	1	338361
Flat Blade	550 mm	1	338360
Flat Blade	580 mm	1	338374
Flat Blade	600 mm	1	338373
Flat Blade	650 mm	1	338372
Flat Blade	700 mm	1	338371
Flat Blade	750 mm	1	338369
Flat Blade	800 mm	1	338368

AGR: 16.200

Wiper Blades for Cars

- OEM-quality guarantees high performance and high speed
- The metallic wiper frame serves as basis for a balanced distribution of power and enables a perfect movement over the window pane
- Good visibility of the road, no seizure and no scratches thanks to the high-quality wipers
- Simple assembly thanks to universal adapter



Title	Length	PU Piece	Article No.
Car Windshield Wiper A29	290 mm	1	047369
Car Windshield Wiper A33	330 mm	1	047370
Car Windshield Wiper A36	360 mm	1	047371
Car Windshield Wiper A38	380 mm	1	047372
Car Windshield Wiper A41	410 mm	1	047373
Car Windshield Wiper A43	430 mm	1	047376
Car Windshield Wiper A45	450 mm	1	047377
Car Windshield Wiper A48	480 mm	1	047378
Car Windshield Wiper A51	510 mm	1	047379
Car Windshield Wiper A53	530 mm	1	047380
Car Windshield Wiper A55	550 mm	1	047381
Car Windshield Wiper A58	580 mm	1	047382
Car Windshield Wiper A60	600 mm	1	047383
Car Windshield Wiper AM61	600 mm	1	047403
Car Windshield Wiper A65	650 mm	1	047384
Car Windshield Wiper A70	700 mm	1	058603

AGR: 16.200

Wiper Blades for Cars with Spoilers

Title	Length	PU Piece	Article No.
Windshield Wiper for Cars AS 51	510 mm	1	047390
Windshield Wiper for Cars AS 53	530 mm	1	047391
Windshield Wiper for Cars AS 55	550 mm	1	047393
Windshield Wiper for Cars AS 60	600 mm	1	047394
Windshield Wiper for Cars AS 65	650 mm	1	047395

AGR: 16.200



Wiper Blades for Cars with Spray Nozzle

Title	Length	PU Piece	Article No.
Windshield Wiper for cars AW 60	600 mm	1	047401

AGR: 16.200



Plastic Rear Wiper for Cars

Title	Length	PU Piece	Article No.
Windshield Wiper for Cars AR 29	290 mm	1	047396
Windshield Wiper for Cars AR 36	360 mm	1	047397
Windshield Wiper for Cars AR 41	410 mm	1	047398

AGR: 16.200



Refill for automotive wiper blades

- Low friction through gaphit coating
- Aquisition costs are lower for replacement rubbers than for
 - Replacement wipers
- Optimal suitable for used vehicles and other manufacturers
- Universally suitable for all vehicles
- Low storage through a bigger package content

Title	Length	Width	Content	PU Package	Article No.
Wiper blade rubber Standard	610 mm	6,3 mm	40 PC	1	250013
Wiper Rubber AERO	750 mm	6.3 mm	20 PC	1	005364
Wiper blade rubber Standard	750 mm	6,3 mm	20 PC	1	250014

AGR: 16.209



Wiperblade refill hybrid

- combines the aerodynamics of Flat bar wipers and the perfect contact with the windshield wipers of traditional technology

Title	Length	Width	Content	PU Package	Article No.
Wiper blade rubber Hybrid	750 mm	6,3 mm	20 PC	1	332103

AGR: 16.209



Wiperblade refill rear asia

Application Area

- Suitable for rear wiper for the following brands: Toyota, Daewoo, Mazda, Mitsubishi, Honda, Nissan, Hyundai, Proton, Isuzu, SaangYong, Kia, Subaru, Lexus, Suzuki, Mahindra, Tata, Daihatsu, Infiniti, Fiat and Alfa Romeo



Title	Length	Width	Content	PU Package	Article No.
Wiper blade Rubber Asia (Rear)	420 mm	6,3 mm	20 PC	1	332303

AGR: 16.209

Wiper Blades for Trucks

- OEM-quality in robust heavy-duty version (complete metallic wiper frame) ensures the high performance of the wiper even under severe water flow conditions
- Metallic wiper frame serves as basis for an equal force distribution and ensures a smooth movement over the screen
- Good visibility of the road, no seizure and no gritting thanks to the high-quality rubber of the wipers
- Easy mounting thanks to the universal adapter



Title	Length	PU Piece	Article No.
Windshield Wiper LKW T 45	450 mm	1	047432
Windshield Wiper LKW T 510	510 mm	1	047433
Windshield Wiper LKW T 55H	550 mm	1	047436
Windshield Wiper LKW T 550	550 mm	1	047435
Windshield Wiper LKW T 60H	600 mm	1	047439
Windshield Wiper LKW T 600	600 mm	1	047438
Windshield Wiper LKW T 65H	650 mm	1	047440
Windshield Wiper LKW T 70	700 mm	1	047441
Windshield Wiper LKW T 70H	700 mm	1	047442
Windshield Wiper LKW T 80S	800 mm	1	047443
Windshield Wiper LKW T 90S	900 mm	1	047444
Windshield Wiper LKW T 100H	1000 mm	1	047445
Windshield Wiper LKW T 100S	1000 mm	1	047446

AGR: 16.210

Refill for Truck Wiper Blades

- Low abrasion thanks to graphite coating
- Purchasing costs for replacement rubbers are lower than for a complete wiper
- Time-saving
- Universally suitable for all vehicles
- Less storage space required thanks to larger packaging unit

Hints

- The AERO version is only suitable for Bosch designs
- Not suitable for Valeo/SWF design

Title	Length	Width	Content	PU Package	Article No.
Wiper Rubber	750 mm	8.5 mm	20 PC	1	005367
Wiper Rubber	1050 mm	8.5 mm	20 PC	1	005368

AGR: 16.219



Hoses with Braid Type B

Characteristics

- NBR nitrile rubber with CO cotton braid, OEM quality according to the requirements of the German automotive industry, Ref DIN 73379-1

Processing Information

- Not suitable for use in the tank
- Not suitable for brake fluid, transmission and engine oil

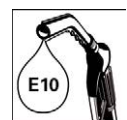
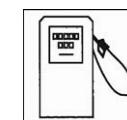
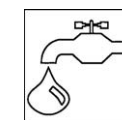
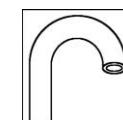
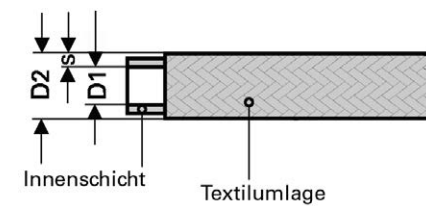
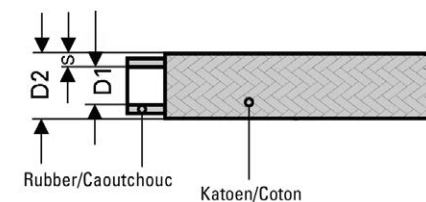

Title	Diameter Internal	External-Ø	Wall Thickness	Lengths, Meter	Color	Vehicle Allocation Manufacturer	Type, Operation	PU Spool	Article No.
Hose with Braid	3.2 mm	7 mm	1.9 mm	20 m	black	BMW Opel / Vauxhall	Diesel return hose	1	340774
Hose with Braid	3.5 mm	7.5 mm	2 mm	20 m	black	Universal	Fuel hose	1	305847
Hose with Braid	4.5 mm	9.5 mm	2.5 mm	20 m	black	Universal	Fuel hose	1	305855
RO PETR.HSE.5MM 15M	5 mm	10 mm	2.5 mm	15 m	black	Universal	Fuel hose	1	144791
Hose with Braid	5.5 mm	10.5 mm	2.5 mm	15 m	black	Universal	Fuel hose	1	298131
RO PETR.HSE.7MM 15M	7 mm	12 mm	2.5 mm	15 m	black	Universal	Fuel hose	1	144790
Hose with Braid	7.5 mm	12.5 mm	2.5 mm	15 m	black	Universal	Fuel hose	1	298140
RO PETR.HSE.9MM 10M	9 mm	14 mm	2.5 mm	10 m	black	Universal	Fuel hose	1	144428
Hose with Braid	10 mm	15 mm	2.5 mm	10 m	black	Universal	Fuel hose	1	298158
Hose with Braid	12 mm	18 mm	3 mm	10 m	black	Universal	Fuel hose	1	402370

AGR: 16.310

Hose with External Rubber Layer Type 2A

Characteristics

- NBR nitrile rubber braiding with CO cotton or viscose CV and CR chloroprene rubber outer layer, abrasion, ozone and light resistant, original equipment in accordance with the requirements of the German automotive industry, based on DIN 73379-1

Processing Information

- Not suitable for use in the tanks
Not suitable for brake fluid, transmission and engine oil

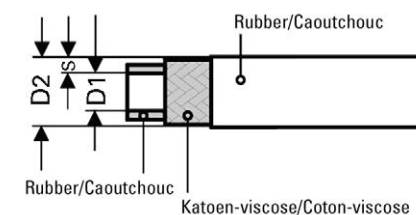

Vehicle tubes and filters

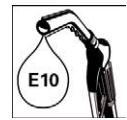
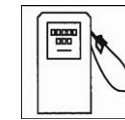
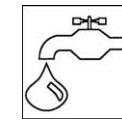
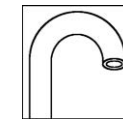
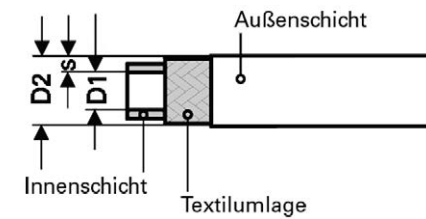

Title	Diameter Internal	External-Ø	Wall Thickness	Lengths, Meter	Color	Vehicle Allocation Manufacturer	PU Spool	Article No.
RO PETR.HSE.4MM 15M	4 mm	10 mm	3 mm	15 m	black	Universal	1	144427
Hose with External Rubber Layer	4.5 mm	10.5 mm	3 mm	15 m	black	Universal	1	307238
Hose with External Rubber Layer	5.3 mm	11.3 mm	3 mm	15 m	black	Universal	1	307297
Hose with External Rubber Layer	5.5 mm	11.5 mm	3 mm	15 m	black	Universal	1	307246
Hose with External Rubber Layer	7 mm	13 mm	3 mm	15 m	black	Universal	1	307556
Hose with External Rubber Layer	7.3 mm	13.3 mm	3 mm	10 m	black	Universal	1	309966
Hose with External Rubber Layer	7.5 mm	13.5 mm	3 mm	10 m	black	Universal	1	309893
RO PETR.HSE.8MM 15M	8 mm	14 mm	3 mm	15 m	black	Universal	1	144425
Hose with External Rubber Layer	9 mm	15 mm	3 mm	10 m	black	Daimler Chrysler	1	309974
Hose with External Rubber Layer	9.3 mm	15.3 mm	3 mm	10 m	black	BMW	1	309990
Hose with External Rubber Layer Type 2A	10 mm	16 mm	3 mm	10 m	black	Universal	1	144424
Hose with External Rubber Layer	11.3 mm	17.5 mm	3.1 mm	10 m	black	BMW	1	310042
RO PETR.HSE.12MM 5M	12 mm	19 mm	3.5 mm	5 m	black	Universal	1	144412
RO PETR.HSE.14MM 5M	14 mm	22 mm	4 mm	5 m	black	Universal	1	144410

AGR: 16.310

INTERNAL/Approved (2019-03-23 01:18:19)

4-Layer Fabric Tube Type 3E

Characteristics

- Fluororubber core against diffusion and ECO epichlorohydrin rubber coating with AR aramide enclosure

Processing Information

- Not suitable for use in the tank
- Not suitable for brake fluid

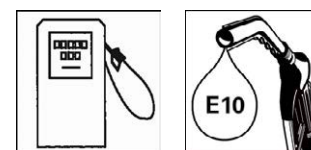
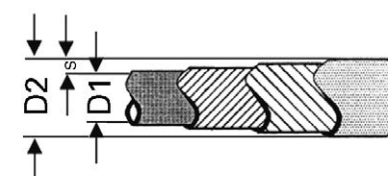

Title	Diameter Internal	External-Ø	Wall Thickness	Lengths, Meter	Color	Vehicle Allocation Manufacturer	Permissible Media	Container	PU Spool	Article No.
RO PETR.HSE.3E 4,5MM 15M	4.5 mm	10 mm	3 mm	15 m	black	Universal	Bio diesel	Spool	1	144792
RO PETR.HSE.3E 5,5MM 15M	5.5 mm	11.5 mm	3 mm	15 m	black	Universal	Bio diesel	Spool	1	144398
4-Layer Fabric Tube	7.3 mm	13.3 mm	3 mm	10 m	black	Universal	Bio diesel	Spool	1	161556
RO PETR.HSE.3E 9,3MM 10M	9.3 mm	15.3 mm	3 mm	10 m	black	Universal	Bio diesel	Spool	1	144322

AGR: 16.310

Braided Hose Type ECO-B

Characteristics

- ECO epichlorohydrin rubber with cotton braid, excellent oil-, fuel- and ozone-resistance
- OEM quality according to the requirements of the German automotive industry

Processing Information

- Not suitable for use in the tank
- Not suitable for brake fluid

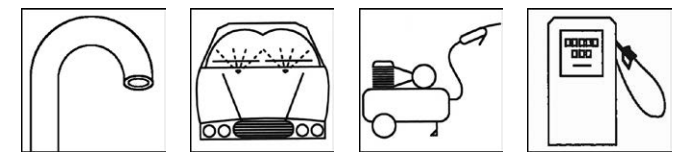
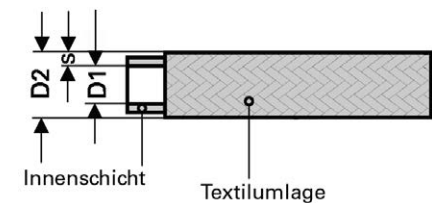

Title	Diameter Internal	External-Ø	Wall Thickness	Lengths, Meter	Color	Vehicle Allocation Manufacturer	Type, Operation	Container	PU Spool	Article No.
Hose with Braid	3.5 mm	7.5 mm	2 mm	15 m	black	VW Audi Seat Skoda	Negative pressure hose Diesel return hose	Spool	1	161294
Hose with Braid	5 mm	10 mm	2.5 mm	15 m	black	VW Audi Seat Skoda	Negative pressure hose	Spool	1	161295

AGR: 16.312

Hose Type ECO-C

Characteristics



INTERNAL/Approved (2019-03-23 01:18:43)

Vehicle tubes and filters

- ECO epichlorohydrin rubber without carbon cotton braid, excellent oil-, fuel- and ozone-resistance, OEM quality according to the requirements of the German automotive industry, various colors - no danger of confusion when being installed in vehicle

Processing Information

- Not suitable for use in the tank
- Not suitable for brake fluid

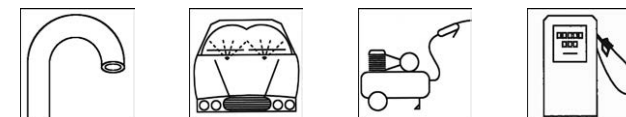
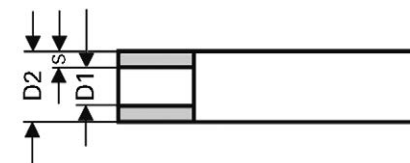

Title	Diameter Internal	External-Ø	Wall Thickness	Lengths, Meter	Color	Vehicle Allocation Manufacturer	Vehicle Allocation, Vehicle Type	Container	PU Spool	Article No.
Hose Type ECO-C	3.3 mm	6.8 mm	1.75 mm	15 m	black / blue	BMW	-	Spool	1	161291
Hose Type ECO-C	3.3 mm	6.8 mm	1.75 mm	15 m	black / red	BMW	-	Spool	1	161290
Hose Type ECO-C	3.3 mm	6.8 mm	1.75 mm	15 m	black / white	BMW	-	Spool	1	161293
Hose Type ECO-C	3.5 mm	8 mm	2.25 mm	15 m	black	BMW VW Audi	-	Spool	1	161289
Hose Type ECO-C	4.5 mm	9 mm	2.25 mm	15 m	black / red	BMW	Motor cycle	Spool	1	161288
Hose Type ECO-C	5 mm	10 mm	2.5 mm	15 m	black	Opel / Vauxhall VW Audi	-	Spool	1	161287
Hose Type ECO-C	7.5 mm	12.5 mm	2.5 mm	15 m	black	-	Motor cycle	Spool	1	161286

AGR: 16.312

Transparent PVC-Hose

Characteristics

- PVC polyvinyl chloride, flexible, flame-retardant, self-extinguishing

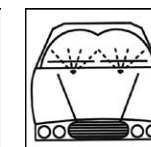
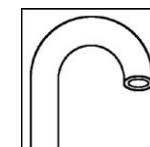
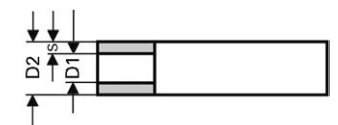
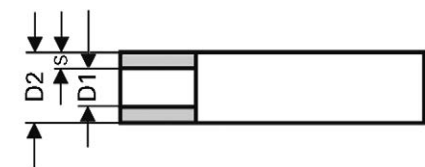

Title	Diameter Internal	External-Ø	Wall Thickness	Lengths, Meter	Color	Vehicle Allocation Manufacturer	PU Spool	Article No.
Transparent PVC Hose	4 mm	7 mm	1.5 mm	15 m	Transparent	Universal	1	365483
Transparent PVC Hose	5 mm	8 mm	1.5 mm	15 m	Transparent	Universal	1	365491
Transparent PVC Hose	6 mm	9 mm	1.5 mm	15 m	Transparent	Universal	1	365513
Transparent PVC Hose	8 mm	11 mm	1.5 mm	15 m	Transparent	Universal	1	365521

AGR: 16.313

PVC hose transparent

- FDA conformity

Application Area

- In the labor, because of its stability against acids and bases
- In engine building because of its flexibility and resistance to abrasion
- For measurement instrumentation and control engineering because of the transparency which enables reliable visual control



Title	Diameter Internal	External-Ø	Wall Thickness	Temperature range	Color	Length	PU Roll	Article No.
PVC hose transparent	3 mm	5 mm	1 mm	-10 - 60 °C	Transparent	100 m	1	335475

AGR: 16.313

Hose with Fabric Interlayer, PVC Transparent

Characteristics

- Polyvinyl chloride with PES-polyester weave, flexible

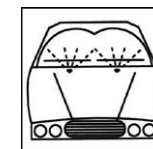
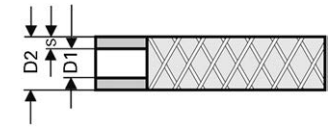
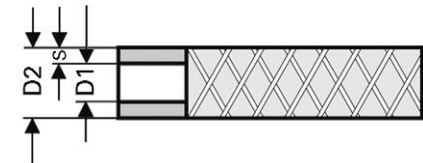
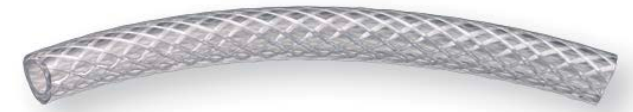

Title	Diameter Internal	External-Ø	Wall Thickness	Lengths, Meter	Color	Vehicle Allocation Manufacturer	Container	PU Spool	Article No.
Transparent PVC Hose with Fabric Interlayer	4.6 mm	7.6 mm	1.5 mm	20 m	Transparent	Universal	Spool	1	298182

AGR: 16.313

Braided Hose

Characteristics

- NBR nitrile rubber, smooth surface

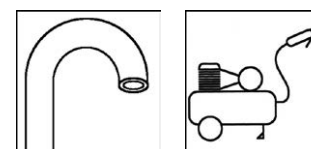
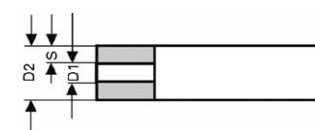
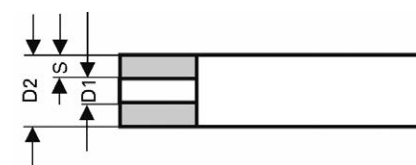

Title	Diameter Internal	External-Ø	Wall Thickness	Lengths, Meter	Color	Vehicle Allocation Manufacturer	Container	PU Spool	Article No.
Hose	3.5 mm	8 mm	2.25 mm	20 m	black	Universal	Spool	1	298190
Hose	5 mm	10 mm	2.5 mm	15 m	black	Universal	Spool	1	298204

AGR: 16.312

Straight Hose Connecting Pieces Type GS

Application Area

- Suitable for control and regulation technology, conveyor pipes for gas and liquides, vacuum and overflow pipes

Characteristics

- Made of acetal resin (acetal copolymer POM)
- High resistance, extreme toughness, high abrasion resistance, low weight, great impact resistancy
- the ribbing on the hose connection guarantees a safe connection between hose and socket
- resistancy against water, washing water, gasoline, diesel, engine oil, hydraulic oil, heating oil, lubricating oil, greases, natural gas, alcohol, brake fluid, glysantin, cooling liquid

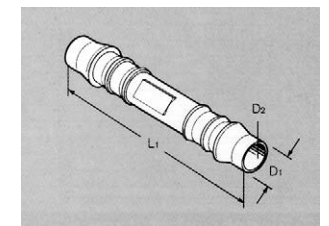

Technical Data

Resistant Against	Water Petrol Diesel fuel Oil Fat Alcohol Brake fluid Glysantin Radiator liquide Natural gas
Color	Nature
Material	Acetal resin (POM)

Title	External-Ø (D1) In mm	Internal Ø (D2) In mm	Length L1	PU Piece	Article No.
Straight Hose Connecting Piece	3 mm	2.5 mm	25 mm	25	003580
Straight Hose Connector Nozzle	4 mm	2.7 mm	35 mm	25	869797
Straight Hose Connecting Nozzle	5 mm	3 mm	45 mm	25	869803
Straight Hose Connector Nozzle	6 mm	4 mm	49 mm	25	814210
Straight Hose Connecting Piece	8 mm	5.6 mm	56 mm	25	930865
Straight Hose Connecting Piece	10 mm	7 mm	63 mm	10	930881
Straight Hose Connecting Piece	12 mm	8.6 mm	66.5 mm	10	930997

AGR: 16.330

INTERNAL/Approved (2019-03-23 01:19:37)

T-Reducer Fitting Type TS

Application Area

- Suitable for control and regulation technology, conveyor pipes for gas and liquides, vacuum and overflow pipes

Characteristics

- Made of acetal resin (acetal copolymer POM)
- High resistance, extreme toughness, high abrasion resistance, low weight, great impact resistancy
- the ribbing on the hose connection guarantees a safe connection between hose and socket
- resistancy against water, washing water, gasoline, diesel, engine oil, hydraulic oil, heating oil, lubricating oil, greases, natural gas, alcohol, brake fluid, glysantin, cooling liquid

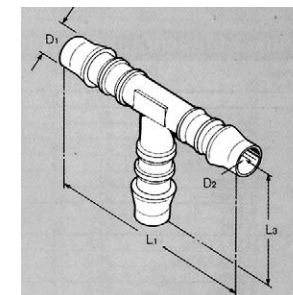

Technical Data

Resistant Against	Water
	Petrol
	Diesel fuel
	Oil
	Fat
	Alcohol
	Brake fluid
	Glysantin
	Radiator liquide
	Natural gas
Color	Nature
Material	Acetal resin (POM)

Title	External-Ø (D1) In mm	Internal Ø (D2) In mm	Length L1	Length (L3) In mm	PU Piece	Article No.
T-Reducer Fitting	3 mm	2.5 mm	25 mm	12.5 mm	25	826383
T-Hose Connector Nozzle	4 mm	2.7 mm	35 mm	19.5 mm	25	869810
T-Hose Connector Nozzle	5 mm	3 mm	42 mm	22 mm	25	814318
T-Hose Connector Nozzle	6 mm	4 mm	50 mm	26 mm	25	863016
T-Reducer Fitting	7 mm	5 mm	50 mm	26 mm	25	931110
T-Hose Connector Nozzles	8 mm	5.6 mm	58 mm	30 mm	25	136535
T-Reducer Fitting	10 mm	7 mm	62.5 mm	33.5 mm	10	931128
T-Reducer Fitting	12 mm	8.6 mm	69 mm	36 mm	10	136536

AGR: 16.330

Y-Hose Connecting Piece Type YS

Application Area

- Suitable for control and regulation technology, conveyor pipes for gas and liquides, vacuum and overflow pipes

Characteristics

- Made of acetal resin (acetal copolymer POM)
- High resistance, extreme toughness, high abrasion resistance, low weight, great impact resistancy
- the ribbing on the hose connection guarantees a safe connection between hose and socket
- resistancy against water, washing water, gasoline, diesel, engine oil, hydraulic oil, heating oil, lubricating oil, greases, natural gas, alcohol, brake fluid, glysantin, cooling liquid

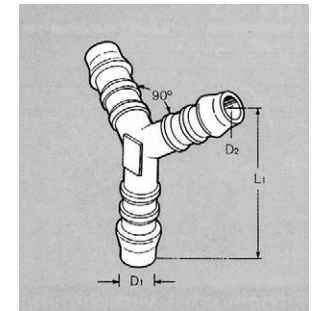

Technical Data

Resistant Against	Water
	Petrol
	Diesel fuel
	Oil
	Fat
	Alcohol
	Brake fluid
	Glysantin
	Radiator liquide
	Natural gas
Color	Nature
Material	Acetal resin (POM)

Title	External-Ø (D1) In mm	Internal Ø (D2) In mm	Length L1	PU Piece	Article No.
Y-Hose Connector Nozzle	4 mm	2.5 mm	25.5 mm	25	814350
Y-Hose Connector Nozzle	5 mm	3 mm	43 mm	25	869841
Y-Hose Connector Nozzle	6 mm	4 mm	44 mm	25	863023
Y-Hose Connector Nozzles	8 mm	5.6 mm	51 mm	25	136521

AGR: 16.330

INTERNAL/Approved (2019-03-23 01:19:51)

Angled Hose Connecting Piece Type WS

Application Area

- Suitable for control and regulation technology, pipelines for gas and liquids, vacuum and overflow pipes

Characteristics

- From acetal (acetal-POM)
- high strength, high toughness, high abrasion resistance, light weight, big impact strength
- The ribbing on the hose connection effect a secure connection between the hose and nozzle
- resistant to water, washing water, gasoline, diesel fuel, motor oil, hydraulic oil, fuel oil, lubricating oil, greases, natural gas, alcohol, brake fluid, Glysantin, coolant

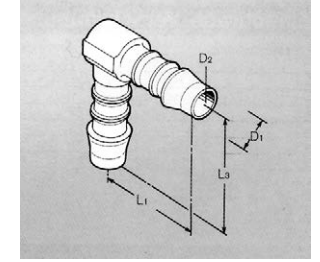
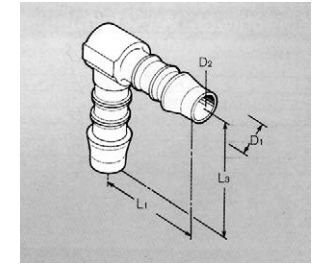

Technical Data

Resistant Against	Water Petrol Diesel fuel Oil Fat Alcohol Brake fluid Glysantin Radiator liquide Natural gas
Color	Nature
Material	Acetal resin (POM)

17

Title	External-Ø (D1) In mm	Internal Ø (D2) In mm	Length L1	Length (L3) In mm	PU Piece	Article No.
Angled Hose Connecting Piece	4 mm	2.5 mm	17.5 mm	19.5 mm	25	003576
Angled Hose Connecting Piece	5 mm	3 mm	21 mm	22 mm	25	136516
Angled Hose Connecting Piece	6 mm	4 mm	25 mm	26 mm	25	136517
Angled Hose Connecting Piece	8 mm	5.6 mm	29 mm	30 mm	25	136518
Angled Hose Connecting Piece	10 mm	7 mm	31 mm	33.5 mm	10	136519

AGR: 16.330

Berner Assortment 4015 Hose Connection Piece

Scope Of Delivery

- 10 dimensions
- 235 parts

Title	PU Piece	Article No.
BS 4015 HOSE CONN.PIECE	1	874371
AGR: 07.908		
Scope Of Supply	Piece	Article No.
FIL F.SCREEN WASH TUBE	10	877488
Straight Hose Connector Nozzle Typ GS 4	25	869797
Straight Hose Connector Nozzle Typ GS 5	25	869803
Straight Hose Connector Nozzle GS 6	25	814210
T-Hose Connector Nozzle Typ TS 4	25	869810
T-Hose Connector Nozzle Typ TS 5	25	814318
T-Hose Connector Nozzle Typ TS 6	25	863016
Y-Hose Connector Nozzle Typ YS 4	25	814350
Y-Hose Connector Nozzle Typ YS 5	25	869841
Y-Hose Connector Nozzle Typ YS 6	25	863023



Fuel Filter uni

Application Area

- Suitable for all carburetor engines

Title	PU Piece	Article No.
Fuel Filter, Universal AGR: 16.900	25	171735

Filter for screen wash tube

Application Area

- Suitable for small engines, and for the filter of the windscreen wiper

Title	PU Piece	Article No.
FIL F.SCREEN WASH TUBE AGR: 16.909	25	877488



"Hose" Dispenser Empty

- Unintended unwinding of the hose is prevented by means of a clamping device

Application Area

- Storage and safe separation of hoses

Characteristics

- Suitable for 3 hose rolls, each roll is individually suspended and can be replaced easily, captive-mounted special scissors for cutting the hoses Specification: sheet steel, powder coated in gray with fixing material



Title	Height x width x depth	PU Piece	Article No.
Hose Dispenser	470 x 420 x 180 mm	1	298026

AGR: 08.195

Accessories Available	PU Amount	Article No.
VDE-Kabelschneider 3K	1	188100

Universal Exhaust System Clamps

Application Area

- Fixation of sound absorber systems with plug connection in vehicles

Characteristics

- Zinc-plated components

Scope Of Delivery

- The completely mounted clamp consists of a lower part, a threaded U-bolt and M 8 hexagonal nuts



Technical Data

Material	Steel
Surface protection	zinc plated

Title	Ø	Diameter, Inch	PU Piece	Article No.
Universal Exhaust System Clamps	36 mm	1 3/8 "	10	015962
Universal Exhaust System Clamps	38 mm	1 1/2 "	10	015970
Universal Exhaust System Clamps	42 mm	1 5/8 "	10	015989
Universal Exhaust System Clamps	45 mm	1 3/4 "	10	015997
Universal Exhaust System Clamps	48 mm	1 7/8 "	10	016004
Universal Exhaust System Clamps	50 mm	2 "	10	016012
Universal Exhaust System Clamps	54 mm	2 1/8 "	10	016020
Universal Exhaust System Clamps	58 mm	2 1/4 "	10	016039
Universal Exhaust System Clamps	60 mm	2 3/8 "	10	543438
Universal Exhaust System Clamps	65 mm	2 5/8 "	10	543446
Universal Exhaust System Clamps	70 mm	2 3/4 "	10	543454

INTERNAL/Approved (2019-03-23 01:20:33)

AGR: 16.340

Exhaust System Clamps for Ford vehicles

Application Area

- Fixation of sound absorber systems with plug connections in Ford vehicles

Scope Of Delivery

- Complete assembly including lower part, white zinc-plated threaded U-bolt as well as a copper hex nut, M10, SW 17

Technical Data

Material	Steel
Surface protection	zinc plated

Title	Ø	PU Piece	Article No.
Exhaust System Clamp for Ford Vehicles	45 mm	10	268640
Exhaust System Clamp for Ford Vehicles	48 mm	10	194646
Exhaust System Clamp for Ford Vehicles	51 mm	10	194689
Exhaust System Clamp for Ford Vehicles	53 mm	10	194654
Exhaust System Clamp for Ford Vehicles	58 mm	10	194638

AGR: 16.341



Tachograph Chart 125 km/h Combination

- Motometer tachograph disc dual suitable for analog tachographs

Application Area

- "Automated and standard tachograph
Trucks: e.g. MB z.B. Atego, MAN, Volvo, DAF, Renault, IVECO, Fiat, Scania
Buses: e.g. MB, Neoplan, Kässbohrer, MAN, Volvo"

Characteristics

- 1 day (24 h) combination, approval no. e1 03, 04, 07, 08, 09, 10, 11, 12, 15, 18, 21, 22, 23, 26, 29, 30, 31, 32, 35, 36, 37, 40, 41, 44, 45, 46, 47, 48, 53, 54, 55, 56, 57, 58, 59, 60, 63, 64, 65, 66, 67, 68, 69, 70, 72, 73, 74, 75, 78, 79, 80, 81, 82, and 83, approval no. e2: 18, 20, approval no. e3: 01, approval no. e11: 0018, 0020, 0027, approval no. e13: 11, approval no. e20: 003

Hints

- Vehicles used to transport goods (from 3.5 t permissible total weight including trailers)
Buses in occasional traffic with more than 8 passengers
Vehicles for the transport of dangerous goods

Scope Of Delivery

- content: 100 pcs

Technical Data

Approval numbers e1	03, 04, 07, 08, 09, 10, 11, 12, 15, 18, 21, 22, 23, 26, 29, 30, 31, 32, 35, 36, 37, 40, 41, 44, 45, 46, 47, 48, 53, 54, 55, 56, 57, 58, 59, 60, 63, 64, 65, 66, 67, 68, 69, 70, 72, 73, 74, 75, 78, 79, 80, 81, 82, 83
Approval numbers e2	18, 20
Approval numbers e3	01
Approval numbers e11	0018, 0020, 0027
Approval numbers e13	11
Approval numbers e20	003

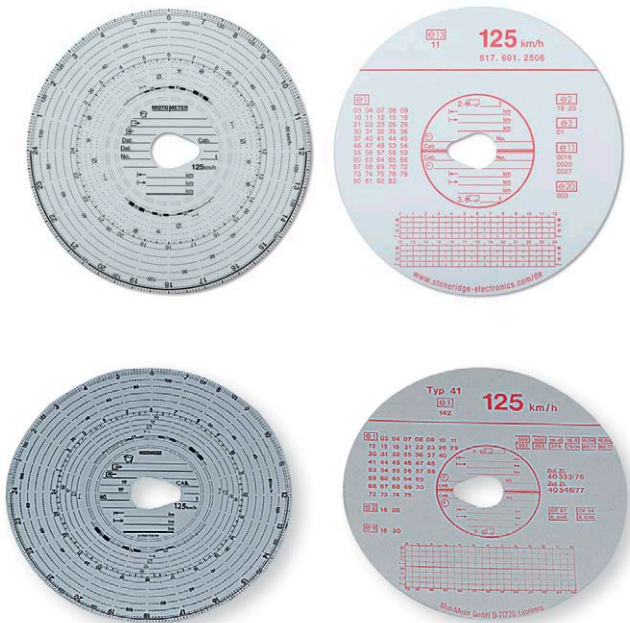

Title	Accordinging number Motometer	Accordinging number Kienzle	Accordinging number VDO	PU Piece	Article No.
Tachograph Chart	517.601.2506	125-24 EC 4K	125-24/2326 EG	1	137601

AGR: 16.933

Tachograph Chart 180 km/h Automated

Application Area

- Automated and standard tachographs
- Trucks: diverse trucks and transporters

Characteristics

- 1 day (24 h), electronic analysis possible, approval no.e1: 57, 60, 72, 73, 82, 83, approval no. e2: 24, approval no. e11: 24, 25, approval no. e13: 12

Hints

- Vehicles used to transport goods (from 3.5 t permissible total weight including trailers)
Buses in occasional traffic with more than 8 passengers
Vehicles for the transport of dangerous goods

Scope Of Delivery

- content: 100 pcs

Technical Data

Approval numbers e1	57, 60, 72, 73, 82, 83
Approval numbers e2	24
Approval numbers e11	24, 25
Approval numbers e13	12

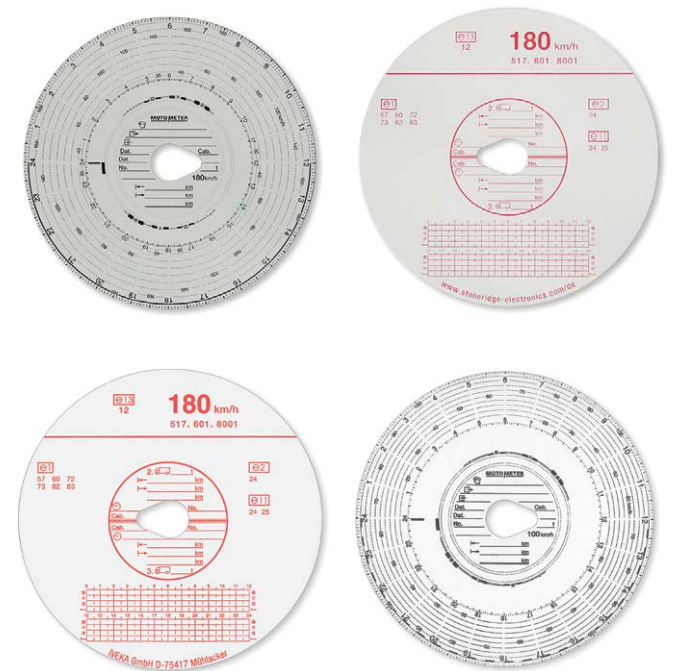

Title	According number Motometer	According number Kienzle	PU Piece	Article No.
Tacograph Chart AGR: 16.933	517.601.8001	180-24 EC 48	1	139100

Chart Sheets

Characteristics

- Design UK 12 = gasoline engine max. 12 bar
- Design UK 17.5 = gasoline engine max. 17.5 bar
- Design DM 40 = diesel engine max. 40 bar
- Design DM 60 = diesel engine max.60 bar

Title	Engine Type	Content	PU Piece	Article No.
Chart sheet DM 40	Diesel	100 PC	100	021415
Chart sheet VK12	Otto	100 PC	100	021385
Chart sheet VK 17.5	Otto	100 PC	100	021393

AGR: 16.933

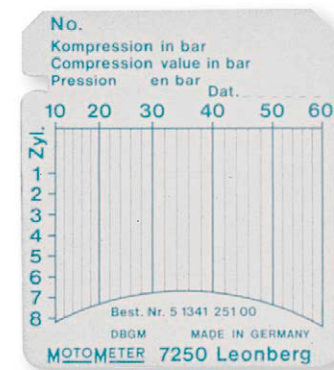

Thermal paper rolls for digital tachographs

- One printing paper for all approved digital tachographs

Hints

- Suitable for the following digital tachographs:
Siemens VDO DTCO 1381
Eikon EFAS-3
Intellic EFAS-4
Actia SmarTach STD
Actia SmarTach ADR
Actia SmarTach STD II
Stoneridge SE 500
- Approval no.: e1 223. According to EEC Regulation 3821/85, changed by 1791/2006, addition B1

Scope Of Delivery

- 3 rolls in a Berner box

Technical Data

Approval numbers e1	84 - 200 - 222
Approval numbers e2	25 - 29 - 30
Approval numbers e5	0002

Title	PU Package	Article No.
10X THERM.F.EG-TRAVELR.40308	1	094491
Thermographic Paper for Digital Tachographs	1/10	040308

AGR: 16.933



Universal Dirt Deflector

Characteristics

- Dimensionally stable, hot-dip galvanized mounting rail, temperature resistant from -30 °C to +60 °C, shore hardness 85 +/- 2

Scope Of Delivery

- Including M5 x 16 screws, zinc-plated and pre-mounted

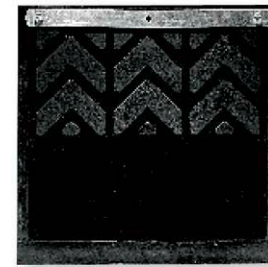

Title	Width x height	PU Piece	Article No.
Dirt Deflector	400 x 300 mm	2	112015
Dirt Deflector	500 x 300 mm	2	112016
Dirt Deflector	600 x 300 mm	2	112019
Dirt Deflector	600 x 400 mm	2	112021

AGR: 16.930

Keyring Pendant

Characteristics

- Made of environmentally friendly PP (Polypropylene) hard foil, with labeling surface on both sides, can be labelled with ball pens or felt pens (no special markers required)

Hints

- Available in blue, green, yellow and red

Title	Length	External Width	PU Package	Article No.
Keyring Pendant	210 mm	35 mm	1	032279
Keyring Pendant	210 mm	35 mm	1	213203
Keyring Pendant	210 mm	35 mm	1	032281
Keyring Pendant	210 mm	35 mm	1	213202

AGR: 16.990



Key Chain ECO

- Easy and fast

Characteristics

- Size: 160 x 12,7 mm
- 1 Pack = 1000 Chains (roll)

Hints

- Available in blue, red, white and green

Title	Height, External	Length	External Width	PU Amount	Article No.
Key Chain ECO, blue	-	160 mm	13 mm	1	213369
Key Chain ECO, green	-	160 mm	13 mm	1	213367
Key Chain ECO, orange	-	160 mm	13 mm	1	218793
Key Chain ECO, red	-	160 mm	13 mm	1	213370
KEY TRAILER ROLL WHITE 1000PC	12.7 mm	160 mm	13 mm	1	059871
KEY TRAILER ROLL YELLOW 1000PC	12.7 mm	160 mm	13 mm	1	059872

AGR: 16.990



Key Trailer Roll Clip



Title	PU Roll	Article No.
Key Trailer Roll Clip AGR: 16.990	1	244193

Tyre trailer

- Perfect storage for summer and winter tyres: quick, safe and very easy to mark
- Very resistant valve pockets made from environmentally-friendly PP material
- Valve pocket can be used several times, therefore it is very economic
- Simple and quick fixing on the valve or on the bolt hole of the wheel rim, therefore wet tyres can be marked as well
- Easy detachment of lables due to perforation lines



Scope Of Delivery

- 100 tags, 30 sheets of labels for marking

Title	PU Package	Article No.
TYRE TRAILER 100PC AGR: 16.090	1	059877

Wheel Storage Sticker and Fob

- Fob: label is safed against clamminess multiple use possible
- Sticker: high quality, light-proof and water-proof with metallic back-site. Optimal adharance also by clamminess and dirt
- Pre-printed DIN A6 label with all necessary data

Application Area

- For the storage of summer and winter wheels

Characteristics

- Size label: 150 x 105 mm
- Size sticker: 80 x 120 mm
- Lenght of the strap: 90 cm

Hints

- Perforated labels, format DIN A6 landscape
- Loop length 80 cm

Scope Of Delivery

- Fob 1 VPE = 100 labels + 100 straps
- Sticker 1 VPE = 100 pieces (roll)
- re-label 1 VPE = 25 x 4 labels (100 labels)

Title	PU Package	Article No.
EXTRA LABEL A6 100 PCS	1	363105
WHEEL FOB WITH LABEL 100 PC	1	213302
WHEELSTORAGE STICKER 100 PC	1	213303

AGR: 16.990



Fob



Fob



Kundenname / customer:	_____
Einlag.-Nr.: / storage no:	_____
Kennzeichen / license plate no:	_____
Fabrikat / brand:	_____
Fahrzeugtyp / model:	_____
Reifengröße / tyre size:	_____
Felgentyp / rim type:	_____
Radkappen / hub caps:	<input type="checkbox"/> ja/yes <input type="checkbox"/> nein/no
Radbolzen / wheel bolts:	<input type="checkbox"/> ja/yes <input type="checkbox"/> nein/no
Position / position:	<input type="checkbox"/> VL/RL <input type="checkbox"/> VR/FR <input type="checkbox"/> HL/RL <input type="checkbox"/> HR/RR _____ mm



Job Folder DIN A4

- Very stable and robust version

Application Area

- Storage of all work papers

Characteristics

- With hook-and-loop fastener (front, upside) and vehicle registration pocket and/or key pocket on the back

Hints

- Available in blue, black, green or red

Title	Color	Content	PU Package	Article No.
Job Folder	black	10 PC	1	213304
Job Folder	Blue	10 PC	1	032276
Job Folder	Green	10 PC	1	213212
Job Folder	Red	10 PC	1	032278
Job Folder	Yellow	10 PC	1	363106

AGR: 16.990

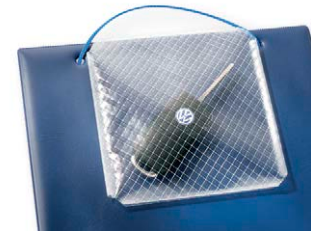

Clipboard DIN A4

- Very stable and robust version

Application Area

- For the simply working paper storage

Characteristics

- Longlife nickel-plated clip mechanism with hook loop

Hints

- Available in blue, red, black and white
- 1 VPE = 12 Clipboards

Title	Color	PU Package	Article No.
Clipboard DIN A4	black	1	213208
Clipboard DIN A4	Blue	1	213211
Clipboard DIN A4	Red	1	213210

AGR: 16.990

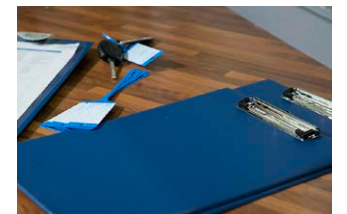

Planing Board DIN A4

- Clearly arranged, immediatly visible which empoyee should fullfil which task. When the job folder is taken out, leave a copy of the order
- Shorages are visible and a optimal time-sharing is ensure
- Solide and easy-care, planning board is processed out of a high-quality polypropylene in a modern design



Title	Subjects, Number	Height, External	Depth, Exterior	External Width	PU Piece	Article No.
PLAN.BOARD DINA4,10ROWS SMALL	10 PC	1285 mm	78 mm	550 mm	1	044703
PLAN.BOARD DINA4,15ROWS SMALL	15 PC	1765 mm	78 mm	550 mm	1	044705*
PLANING BOARD DIN A4, 10 ROWS	10 PC	1285 mm	78 mm	1575 mm	1	044702
PLANING BOARD DIN A4, 15 ROWS	15 PC	1765 mm	78 mm	1575 mm	1	044704*
PLANING BOARD DIN A4, 6 ROWS	6 PC	900 mm	78 mm	1575 mm	1	044701

* = The delivery time is 14 days
AGR: 16.990

Service fobs and service sticker

- Service fobs with suitable binding wires in a box
- Service sticker in a practical storage box

Application Area

- Hints for mechnics and drivers

Characteristics

- Size service fob: 65 x 100 mm
- Size service sticker: 60 x 100 mm
- Size oil and wheel tighten sticker: 60 x 40 mm

Title	PU Amount	Article No.
Service Fob	1	213206
SERVICE STICKER 100PCS.	1	180931
STICKER DRIVE BELT 250PCS.	1	180547
STICKER OIL CHANGE 250PCS.	1	180546
Sticker Wheel Tighten	1	213205

AGR: 16.990

Motoröl (Sorte): _____
 Nächster Ölwechsel bei km: _____
 Kühlerfrostschutz gesichert bis: - _____ °C
 Durchgeführte Kontrollen/Arbeiten:
 Ölservice Inspektion
 kontrolliert erneuert
 Luftfilter
 Kraftstofffilter
 Zündkerzen
 Aktivkohlefilter
 Getriebeöl
 Zahnriemen
 Bremsflüssigkeit
 Bei km-Stand: _____

Front service fob

Motoröl (Sorte): _____
 Nächster Service/ Ölwechsel am/ bei km: _____
 Kühlerfrostschutz gesichert bis: - _____ °C
 Durchgeführte Kontrollen/Arbeiten:
 Ölservice Inspektion
 kontrolliert erneuert
 Luftfilter
 Kraftstofffilter
 Zündkerzen
 Aktivkohlefilter
 Getriebeöl
 Zahnriemen
 Bremsflüssigkeit
 Bei km-Stand: _____
 (Stempel/Unterschrift)

service sticker

Arbeiten ausgeführt am/ bei km: _____
 Nächster Service am/ bei km: _____
 Allzeit Gute Fahrt wünscht Ihnen:
 (Stempel/Unterschrift)

back fob



Example fob

Öl-Wechsel ausgeführt bei:
 _____ Datum
 _____ km-Stand
 Unterschrift

ACHTUNG!
 Bitte nach 50 - 100 gefahrenen Kilometern alle Räder nachziehen lassen.

Anti-theft protection/cap Diesel

- Diesel theft-protection:
- Without a lot of tools, the Diesel-Safe is easily attached and embedded to the tank filler neck
- The original tank cap can be further on used
- Fixed installation
- Biodiesel-resistant rubber seal rings
- Rising of the tank filler neck of about 25 mm
- Diesel filler cap incl. 2 keys
- Universal filler cap
- Bajonet mounting
- Inside dimension Ø 80 mm

Application Area

- The Diesel-safe is used to prevent a fuel theft from the truck tank

Hints

- Suitable for all common truck brands (not for Scania, because of the screw thread seal)

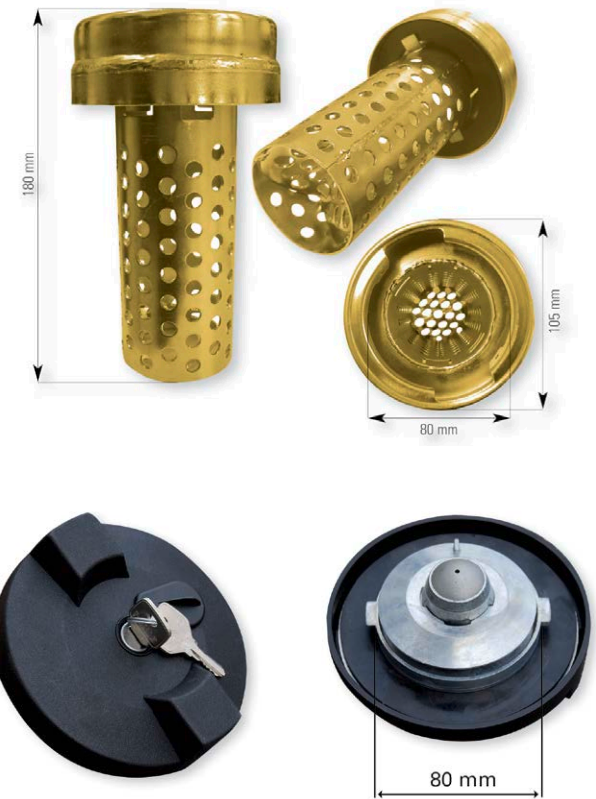

Title	PU Piece	Article No.
ANTI-THEFT CAP DIESEL 105MM	1	042305
AGR: 16.955		
Accessories Available	PU Piece	Article No.
TANK COVER 80MM UNIV 6195	1	147426