

Bera-Clic Maxi

Characteristics

- Individual layout with 3 different cross partitions and longitudinal partitions, can be combined optionally with Bera-Clic sizes 1 – 5 and Maxi

Hints

- The edges of the inner separator plate and the small separator plate must be snapped off



15



INTERNAL/Approved (2019-03-22 23:27:12)

Title	External width x depth x height	Volume, Gross	Weight	PU Piece	Article No.
-------	---------------------------------	---------------	--------	----------	-------------

Bera Clic cases system

Drawer Case for Bera Clic

Title	Outside dimension W x H x D	PU Piece	Article No.
Bera-clic drawer, medium	167 x 34 x 255 mm	1	001442
Bera-clic drawer partition set, medium (x5)	-	1	001445
Bera-clic drawer, large	350 x 85 x 250 mm	1	001443
Bera-clic drawer partition set, large (x2)	-	1	001446

AGR: 07.201



Bera Clic + Tool Box

- Stackable and linkable to the BERA CLIC + and Bera clic generation
- Two spacious open compartments with deep center bar for quick storage of small parts and tools
- Bera CLIC + tool boxes can be linked together
- High stability

Application Area

- A smart organizer of small parts, tools and power tools at the construction site and in the workshop

Hints

- Contents not included



Title	External width x depth x height	Total Height	Weight	PU Piece	Article No.
Bera Clic+ Tool Box Size 1	396 x 296 x 143 mm	208 mm	1.3 kg	1	175138

AGR: 07.202

15

BERA CLIC+ Module Case

- Complete with 16 single removable colored plastic boxes
- Individually equipped classification system for small parts
- Uniform standard size of the boxes provides variable arrangement option in the boot
- Structured fixed base tray boxes and ensures order and when individual boxes are removed

Application Area

- A smart organizer at the construction side and in the workshop due to a fast and easy connection of the cases between small parts, tools and electrical tool
- Versatile accessory program ensures a combination of individual needs

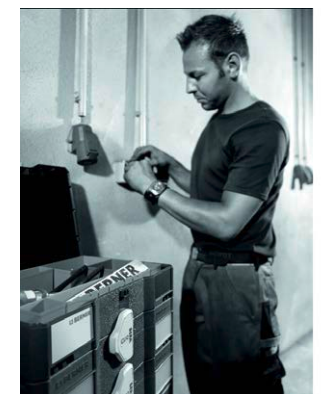

INTERNAL/Approved (2019-03-22 23:27:23)

Bera Clic cases system

Hints

- By special structure of the boxes and the floor pan the boxes will remain even after removing individual boxes stable in its case and items are not mixed.
The BERA CLIC + Modulbox orange must be positioned because of their recess at the location shown

Title	External width x depth x height	PU Piece	Article No.
BC+ MODULE CASE SZ.1	396 x 296 x 105 mm	1	104079

AGR: 07.204

Scope Of Supply

	Piece	Article No.
BC+ system case sz. 1	1	102544
Cover Pad EPP Module	1	104062
BC+ BLUE MODULE CASE 98 x 71 x 98	2	104115
BC+EMPTY BASE PLATE	1	104125
BC+ YELLOW MODULE CASE 98 x 71 x 49	7	104094
BC+ GREEN MODULE CASE 147 x 71 x 98	1	104088
BC+ ORANGE MODULE CASE 245 x 71 x 49	1	104124
BC+ RED MODULE CASE 49 x 71 x 49	2	104116

Bera-clic+ mini



Title	External width x depth x height	Volume, Gross	Weight	PU Piece	Article No.
Bera-clic+ mini	265 x 171 x 71 mm	3.2 l	0.4 kg	1	200999

AGR: 07.202

Bera Clic+ system MIDI

- High stability
- Protection against dust and moisture
- Quick opening and stacking of the cases with one turn
- Ergonomic handle
- Innovative marking field in cheque card format

Application Area

- A smart organizer at the construction site and in the workshop due to a fast and easy connection of the cases between small parts, tools and electrical tool
- Versatile accessory program ensures a combination of individual needs

Hints

- Compatible with cases of the first generation. New case above the old case



15

Title	External width x depth x height	Volume, Gross	Weight	PU Piece	Article No.
BERA CLIC+ MIDI size 2	496 x 296 x 158 mm	20 l	1.9 kg	1	187117

AGR: 07.202

Bera Clic cases system

BERA CLIC+ system case sz. 1

- High stability
- Protected against dust and moisture
- Comprehensive assortment program
- Quick opening by one hand operation
- Batch function with one trick
- Ergonomic handle
- Innovative marking field in cheque card format

Application Area

- A smart organizer at the construction side and in the workshop due to a fast and easy connection of the cases between small parts, tools and electrical tool
- Versatile accessory program ensures a combination of individual needs

Hints

- Compatible with cases of the first generation. New case above the old case

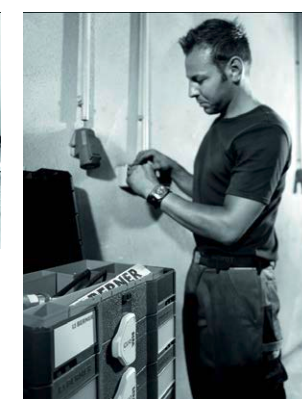

Title	External width x depth x height	Volume, Gross	Weight	PU Piece	Article No.
BC+ system case sz. 1	396 x 296 x 105 mm	8 l	1.3 kg	1	102544

AGR: 07.202

Bera Clic+ system case sz. 2

- High stability
- Protected against dust and moisture
- Comprehensive assortment program
- Quick opening by one hand operation
- Batch function with one trick
- Ergonomic handle
- Innovative marking field in cheque card format

Application Area

- A smart organizer at the construction side and in the workshop due to a fast and easy connection of the cases between small parts, tools and electrical tool
- Versatile accessory program ensures a combination of individual needs

Hints

- Compatible with cases of the first generation. New case above the old case

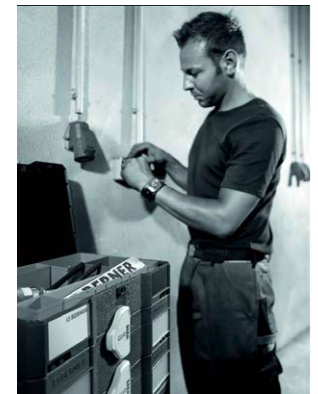

Title	External width x depth x height	Volume, Gross	Weight	PU Piece	Article No.
Bera Clic+ system case sz. 2	396 x 296 x 157.5 mm	13 l	1.5 kg	1	102545

AGR: 07.202

Bera Clic cases system

BERA CLIC+ system case sz. 3

- High stability
- Protected against dust and moisture
- Comprehensive assortment program
- Quick opening by one hand operation
- Batch function with one trick
- Ergonomic handle
- Innovative marking field in cheque card format

Application Area

- A smart organizer at the construction side and in the workshop due to a fast and easy connection of the cases between small parts, tools and electrical tool
- Versatile accessory program ensures a combination of individual needs

Hints

- Compatible with cases of the first generation. New case above the old case



Title	External width x depth x height	Volume, Gross	Weight	PU Piece	Article No.
BERA CLIC+ system case sz. 3 AGR: 07.202	396 x 296 x 210 mm	18 l	1.8 kg	1	102546

BERA CLIC+ system case sz. 4

- High stability
- Protection against dust and moisture
- Quick opening and stacking of the cases with one turn
- Ergonomic handle
- Innovative marking field in cheque card format

Application Area

- A smart organizer at the construction site and in the workshop due to a fast and easy connection of the cases between small parts, tools and electrical tool
- Versatile accessory program ensures a combination of individual needs

Hints

- Compatible with cases of the first generation. New case above the old case



Title	External width x depth x height	Volume, Gross	Weight	PU Piece	Article No.
BERA CLIC+ system case sz. 4	396 x 296 x 315 mm	29 l	2.1 kg	1	102547

AGR: 07.202

Bera Clic cases system

BERA CLIC+ system case sz. 5

- High stability
- Protection against dust and moisture
- Quick opening and stacking of the cases with one turn
- Ergonomic handle
- Innovative marking field in cheque card format

Application Area

- A smart organizer at the construction site and in the workshop due to a fast and easy connection of the cases between small parts, tools and electrical tool
- Versatile accessory program ensures a combination of individual needs

Hints

- Compatible with cases of the first generation. New case above the old case

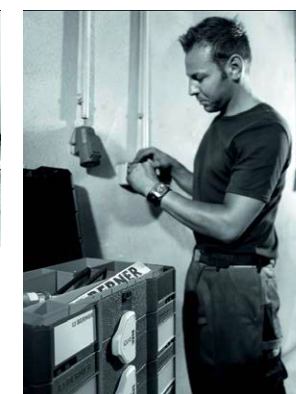

Title	External width x depth x height	Volume, Gross	Weight	PU Piece	Article No.
BERA CLIC+ system case sz. 5	396 x 296 x 420 mm	38.8 l	2.7 kg	1	102548

AGR: 07.202

BERA CLIC+ Storage Box

- Stackable and connectable with other Bera Clic+ cases and tool boxes
- Can be equipped individually and flexible with tools and consumables
- Tidy storage of small parts
- Maximum use of the interior due to hinged upper compartments
- High stability
- Ergonomic handle
- Detachable insert boxes (2x Small, 2x Medium, 1x Big)

Application Area

- A smart organizer at the construction site and in the workshop for small part, tools and power tools due to a fast and easy connection of the cases

Hints

- Compatible with cases of the first generation. New case above the old case



Title	External width x depth x height	Total Height	PU Piece	Article No.
BERA CLIC+ Storage Box	396 x 296 x 160 mm	233 mm	1	337798
Accessories Available				PU Piece
ACCESSORIES SET BC+ DRAWERS			1	337800

BERA CLIC+2 Combi With Drawer

- Combination of Bera Clic+ size 2 and a drawer underneath enables a separated storage of powertools or tools and consumables
- Variable and individual arrangement within drawer through 2 separating webs
- Protected against dust and moisture
- Comprehensive assortment program
- Quick opening of the case by one hand operation
- Quick opening of the drawers without unstacking towered-up cases



INTERNAL/Approved (2019-03-22 23:28:45)

Bera Clic cases system

- High stability
- Ergonomic handle
- Innovative marking field in cheque card format

Application Area

- A smart organizer of small parts, tools and power tools at the construction site and in the workshop

Hints

- Compatible with cases of the first generation. New case above the old case



Title	External width x depth x height	Weight	PU Piece	Article No.
BERA CLIC+2 Combi With Drawer	396 x 296 x 263 mm	3.20 kg	1	337801
Accessories Available				PU Piece
ACCESSORIES SET BC+ DRAWERS			1	337800

15

BERA CLIC+ with Drawers

- With 3 drawers to store consumables
- Each drawer has two dividers for a better separation
- High stability
- Protected against dust and moisture
- Comprehensive assortment program
- Quick opening of the drawers by one hand operation without unstacking towered-up cases
- Ergonomic handle
- Innovative marking field in cheque card format

Application Area

- A smart organizer of small parts, tools and power tools at the construction site and in the workshop

Hints

- Compatible with cases of the first generation. New case above the old case



Bera Clic cases system

Title	External width x depth x height	Weight	PU Piece	Article No.
BERA CLIC+ with drawers	396 x 296 x 315 mm	5.75 kg	1	337802
AGR: 07.202				
Accessories Available			PU Piece	Article No.
ACCESSORIES SET BC+ DRAWERS			1	337800

Bera Clic+1+Inlet 2-Compartment



15

Title	PU Piece	Article No.
BC+1 + INLET 2FOLD	1	102549
Scope Of Supply		
BERA CLIC+ Cushion Lids	1	104057
BERA CLIC+ 2-Component Inlet	1	102566
BC+ system case sz. 1	1	102544

INTERNAL/Approved (2019-03-22 23:29:03)

Bera Clic+1+Inlet 4-Compartment



15

Title	PU Piece	Article No.
BC+1 + INLET 4WAY	1	102550
AGR: 07.203		
Scope Of Supply	Piece	Article No.
BERA CLIC+ Cushion Lids	1	104057
BERA CLIC+ 4 in 1 Component Inlet	1	102567
BC+ system case sz. 1	1	102544

INTERNAL/Approved (2019-03-22 23:29:08)

Bera Clic cases system

Bera Clic+1+Inlet 5-Compartment



15

Title	PU Piece	Article No.
BC+1 + INLET 5-COMPT.	1	102551
AGR: 07.203		
Scope Of Supply	Piece	Article No.
BERA CLIC+ Cushion Lids	1	104057
BERA CLIC+ 5 in 1 Component Inlet	1	102568
BC+ system case sz. 1	1	102544

INTERNAL/Approved (2019-03-22 23:29:17)

Bera Clic+1+Inlet 7-Compartment



15

Title	PU Piece	Article No.
BC+1 + INLET 7WAY	1	102552
AGR: 07.203		
Scope Of Supply	Piece	Article No.
BERA CLIC+ Cushion Lids	1	104057
BERA CLIC+ 7 in 1 Component Inlet	1	102571
BC+ system case sz. 1	1	102544

INTERNAL/Approved (2019-03-22 23:29:22)

Bera Clic cases system

Bera Clic+1+Inlet 8-Compartment



15

Title	PU Piece	Article No.
BC+1 + INLET 8-COMPT.	1	102553
AGR: 07.203		
Scope Of Supply		Piece Article No.
BERA CLIC+ Cushion Lids	1	104057
BERA CLIC+ 8 in 1 Component Inlet	1	102574
BC+ system case sz. 1	1	102544

INTERNAL/Approved (2019-03-22 23:29:30)

Bera Clic+1+Inlet 14-Compartment



15

Title	PU Piece	Article No.
BC+1 + INLET 14FOLD	1	102554
AGR: 07.203		
Scope Of Supply	Piece	Article No.
BERA CLIC+ Cushion Lids	1	104057
BERA CLIC+ 14 in 1 Component Inlet	1	102575
BC+ system case sz. 1	1	102544

INTERNAL/Approved (2019-03-22 23:29:34)

Bera Clic cases system

Bera Clic+1+Inlet 18-Compartment



15

Title	PU Piece	Article No.
BC+1 + INLET 18FOLD	1	102555
AGR: 07.203		
Scope Of Supply		Piece Article No.
BERA CLIC+ Cushion Lids	1	104057
BERA CLIC+ 18 in 1 Component Inlet	1	102576
BC+ system case sz. 1	1	102544

INTERNAL/Approved (2019-03-22 23:29:43)

Bera Clic+3 Tool Case Empty



Title	PU Piece	Article No.
BC+3 TOOL CAS. EMPTY	1	102556
AGR: 07.203		
Scope Of Supply		Piece Article No.
BC+ INLET TOOL / 4460A	1	102579
BC+ INLET TOOL COVER	1	106794
BERA CLIC+ 8 in 1 Component Inlet	1	102581
BC+ system case sz. 3	1	102546

INTERNAL/Approved (2019-03-22 23:29:47)

Bera Clic cases system

Bera Clic+4 Cartridge Box Empty



Title	PU Assortment	Article No.
BC+ 4 CARTR BOX EMPTY	1	115657
AGR: 07.213		
Scope Of Supply	Piece	Article No.
BC+ system case sz. 4	1	102547
BC+ CARTRIDGE INSERTER	1	115689

Bera Clic+1 Plasterboard Plugs

- The ideal mounting assortment during assembly on plasterboards

Characteristics

- Plasterboard anchors + matching chipboard screws 4x30 up to 4x50 + bit sockets

Title	PU Assortment	Article No.
BC+1 PLASTERBOARD PLUGS	1	102650
AGR: 07.210		
Scope Of Supply	Piece	Article No.
Chipboard Screw Easycl. Pan Head Tx20 4x30 zinc-plated	400	085476
Chipboard Screw Easycl. Pan Head Tx20 4x40 zinc-plated	300	085478
Chipboard Screw Easyclassic sunk-head PZD 4x50 yellow zinc-plated	200	086668
EXPRESSdrill drywall anchors	200	101625
SPEEDdrill drywall anchors	200	113556
Bit for EXPRESSdrill	2	101646
High Quality Bit 1/4" Pozidrive PZ2 25 mm	2	051101
Spare Parts	PU Piece	Article No.
BC+ system case sz. 1	1	102544
BERA CLIC+ Cushion Lids	1	104057
BERA CLIC+ 8 in 1 Component Inlet	1	102574



Bera Clic cases system

Bera Clic+1 Cavity Anchor

- The ideal mounting assortment during assembly on plasterboards, at high load requirements

Characteristics

- Hollow space anchor+scre+mounting plier

Title	PU Assortment	Article No.
Bera Clic+1 Cavity Anchor	1	102723
AGR: 07.210		
Scope Of Supply	Piece	Article No.
Hollow Space Anchor Pliers offset	1	290459
CAVITYfix cavity anchors	60	159428
CAVITYfix cavity anchors	50	159426
CAVITYfix cavity anchors	60	159424
CAVITYfix cavity anchors	40	159421
CAVITYfix cavity anchors	15	159418
Spare Parts	PU Piece	Article No.
BERA CLIC+ 14 in 1 Component Inlet	1	102575
BC+ system case sz. 1	1	102544
BERA CLIC+ Cushion Lids	1	104057



Bera Clic+2 MCS Brick

- If no dovel is sufficient. Everything immediately ready for a tension-free anchoring in all solid building materials and cavity materials

Characteristics

- The BERA CLIC+ case size 2 contains everything, from the composite mortar to the injection gun, which is needed for a chemical fastening



Bera Clic cases system

Title	PU Assortment	Article No.
BC+2 MCS BRICK	1	103192
AGR: 07.211		
Scope Of Supply	Amount	Article No.
Drill Hole Blower small	1	831867
Anchor sleeve MCS Plus H	20	080538
T-Mixer for Multicompondsystem MCS Brick/Universal	10	369427
MVS 2-component standard application gun	1	908312
Hammer drill bit SUPERSpeed II SDS-plus 14x150/210	1	213572
Hammer drill bit SUPERSpeed II SDS-plus 16x150/210	1	213581
BERA CLIC+ BERA CLIC+ MULTICOMPOUND System for Inlet	1	102563
BERA CLIC+ Cushion Lids	1	104057
Bera Clic+ system case sz. 2	1	102545
MULTICOMPOUNDsystem MCS Brick 410ml	2	245347
Spare Parts	PU Piece	Article No.
BERA CLIC+ BERA CLIC+ MULTICOMPOUND System for Inlet	1	102563
BERA CLIC+ Cushion Lids	1	104057
Bera Clic+ system case sz. 2	1	102545



Bera Clic cases system

Bera Clic+2 MCS Universal

- Especially for users which do not work with chemical mounts regularly.

Characteristics

- The BERA CLIC+ case size 2 contains everything, from the composite mortar to the injection gun, which is needed for a chemical fastening



Title	PU Assortment	Article No.
BC+2 MCS UNIVERSAL	1	103193
AGR: 07.211		
Scope Of Supply	Amount	Article No.
T-Mixer for Multicompoundsystem MCS Brick/Universal	20	369427
Drill Hole Blower small	1	831867
Hammer drill bit SUPERSpeed II SDS-plus 16x150/210	1	213581
Anchor sleeve MCS Plus H	10	080537
COMPOUNDM. MCS UNIVERSAL 300ML	2	245349
Skeleton cartridge gun 310ml	1	812106
BERA CLIC+ Cushion Lids	1	104057
Bera Clic+ system case sz. 2	1	102545
BERA CLIC+ BERA CLIC+ MULTICOMPOUND System for Inlet	1	102563
Hammer drill bit SUPERSpeed II SDS-plus 14x150/210	1	213572
Spare Parts	PU Piece	Article No.
BERA CLIC+ BERA CLIC+ MULTICOMPOUND System for Inlet	1	102563
BERA CLIC+ Cushion Lids	1	104057
Bera Clic+ system case sz. 2	1	102545

Bera Clic+1 Plug+SDS-Drill

- The practical drilling and dowel assortment for every handicraft trade

Characteristics

- Nylon dowel with a diameter of 6, 8, 10, 12 mm + matching hammer drills

Title	PU Assortment	Article No.
BC+1 PLUG+SDS-DRILLING	1	102646
AGR: 07.210		
Scope Of Supply	Piece	Article No.
SUPERspeed SDS-Plus 6x50/110 mm	1	-
SUPERspeed SDS-Plus 8x100/160 mm	1	-
SUPERspeed SDS-Plus 10x100/160 mm	1	-
UNIVERSALfix plug with collar	200	175557
UNIVERSALfix plug with collar	100	175558
UNIVERSALfix plug with collar	50	001696
Universal wall plugs CLASSICfix	100	051900
Universal wall plugs CLASSICfix	50	051918
Universal wall plugs CLASSICfix	25	051926
Spare Parts	PU Piece	Article No.
BERA CLIC+ 7 in 1 Component Inlet	1	102571
BERA CLIC+ Cushion Lids	1	104057
BC+ system case sz. 1	1	102544



Bera Clic cases system

BC+1 EASY Classic Screw PZ+BITS

- The most important chipboard screw in ta practical sortiment for the assembly, always ready to hand.

Characteristics

- Chipboard screws yellow zi with PZD drive of 2.5x30 up to 6x80 + bit-socket PZD

Title	PU Assortment	Article No.
BC+1 EASY CL.SCREW PZ+BITS	1	119118

AGR: 07.210

Scope Of Supply	Piece	Article No.
Chipboard Screw Easyclassic sunk-head PZD 4x30 yellow zinc-plated	400	086664
Chipboard Screw sunk-head partial thread PZD 4,0X40 yellow zinc-plated	250	086957
High Quality Bit 1/4" Pozidrive PZ2 25 mm	5	051101
Chipboard Screw Easyclassic sunk-head PZD 3,5x30 yellow zinc-plated	400	086653
Chipboard Screw sunk-head partial thread PZD 3,5X35 yellow zinc-plated	400	086951
Chipboard Screw sunk-head partial thread PZD 4,0X50 yellow zinc-plated	100	086959
Chipboard Screw sunk-head partial thread PZD 5,0X50 yellow zinc-plated	100	086978
Chipboard Screw sunk-head partial thread PZD 6,0X60 yellow zinc-plated	100	086988
Chipboard Screw sunk-head partial thread PZD 6,0X80 yellow zinc-plated	100	086990
High Quality Bit 1/4" Pozidrive PZ3 25 mm	5	118052

Spare Parts	PU Piece	Article No.
BERA CLIC+ Cushion Lids	1	104057
BERA CLIC+ 8 in 1 Component Inlet	1	102574
BC+ system case sz. 1	1	102544



BC+1 EASY Classic Screw TX+BITS

- The most important chipboard screw in ta practical sortiment for the assembly, always ready to hand.

Characteristics

- Chipboard screws yellow zi with TX drive of 2.5x30 up to 6x80 + bit-socket TX

Title	PU Assortment	Article No.
BC+1 EASY CL.SCREW TX+BITS	1	119119

AGR: 07.210

Scope Of Supply	Piece	Article No.
Chipboard Screw Easyclassic sunk-head Tx20 4x30 yellow zinc-plated	250	086844
High Quality Bit 1/4" Torx TX30 25 mm	5	261840
Chipboard Screw Easyclassic sunk-head Tx20 3,5x30 yellow zinc-plated	500	086833
Chipboard Screw partial thread TX20 3,5X35 yellow zinc-plated	500	087080
Chipboard Screw partial thread TX20 4,0X40 yellow zinc-plated	250	087085
Chipboard Screw partial thread TX20 4,0X50 yellow zinc-plated	250	087087
Chipboard Screw partial thread TX20 5,0X50 yellow zinc-plated	200	087107
Chipboard Screw partial thread TX30 6,0X60 yellow zinc-plated	100	087115
Chipboard Screw partial thread TX30 6,0X80 yellow zinc-plated	100	087117
High Quality Bit 1/4" Torx TX20 25 mm	5	246999

Spare Parts	PU Piece	Article No.
BERA CLIC+ 8 in 1 Component Inlet	1	102574
BERA CLIC+ Cushion Lids	1	104057
BC+ system case sz. 1	1	102544



Bera Clic cases system

Chipboard Screws Easy Classic Torx

- The assortment of the most common chipboard screws TX indispensable for the building trade

Characteristics

- Chipboard screws TX insulated + magnetic force holder + bit sockets TX

Title	PU Assortment	Article No.
BC+1 EASY CL.SCR. TX YZP 3-3,5	1	119120

AGR: 07.210

Scope Of Supply

	Piece	Article No.
Chipboard Screw Easyclassic sunk-head Tx10 3x17 yellow zinc-plated	1000	086820
Chipboard Screw Easyclassic sunk-head Tx10 3x20 yellow zinc-plated	1000	086821
Chipboard Screw partial thread TX20 3,5X50 yellow zinc-plated	250	087083
Magnetic Bit Holder 1/4" 60 mm	1	051730
Chipboard Screw Easyclassic sunk-head Tx10 3x25 yellow zinc-plated	1000	086822
Chipboard Screw Easyclassic sunk-head Tx10 3x30 yellow zinc-plated	500	086823
Chipboard Screw Easyclassic sunk-head Tx20 3,5x17 yellow zinc-plated	1000	086830
Chipboard Screw partial thread TX10 3,0X35 yellow zinc-plated	500	-
Chipboard Screw partial thread TX20 3,5X35 yellow zinc-plated	500	087080
High Quality Bit 1/4" Torx TX10 25 mm	2	261815
High Quality Bit 1/4" Torx TX20 25 mm	2	246999

Spare Parts

	PU Piece	Article No.
BERA CLIC+ 8 in 1 Component Inlet	1	102574
BERA CLIC+ Cushion Lids	1	104057
BC+ system case sz. 1	1	102544



Bera Clic+1 DIN 84/934/125 Zinc Plated

- The range of the most common threaded bolts, cyl.-head DIN 84 + U-discs + nuts
- versatile applicable

Characteristics

- Threaded bolts with a longitudinal slit sorted 3x10 up to 6x20 + matching disc or nut



Title	PU Assortment	Article No.
BC+1 DIN 84/934/125 ZP	1	102722
AGR: 07.210		
Scope Of Supply	Piece	Article No.
Slotted Cheese Head Screw DIN84 4.8 M4X30 zinc-plated	100	072478
Slotted Cheese Head Screw DIN84 4.8 M5X30 zinc-plated	50	072648
Hexagon Nuts DIN934 steel 8 M5 zinc-plated	250	004340
Hexagon Nuts DIN934 steel 8 M6 zinc-plated	150	004359
Hexagon Nuts DIN934 steel 8 M3 zinc-plated	250	004324
Hexagon Nuts DIN934 steel 8 M4 zinc-plated	250	004332
Slotted Cheese Head Screw DIN84 4.8 M3X10 zinc-plated	200	072257
Slotted Cheese Head Screw DIN84 4.8 M4X16 zinc-plated	100	072435
Slotted Cheese Head Screw DIN84 4.8 M5X16 zinc-plated	100	072591
Slotted Cheese Head Screw DIN84 4.8 M6X10 zinc-plated	50	072753
Slotted Cheese Head Screw DIN84 4.8 M6X20 zinc-plated	50	072800
Slotted Cheese Head Screw DIN84 4.8 M3X25 zinc-plated	100	072290
Slotted Cheese Head Screw DIN84 4.8 M4X8 zinc-plated	200	072400
Slotted Cheese Head Screw DIN84 4.8 M5X10 zinc-plated	100	072575
Flat Washers DIN125-1 A M3 zinc-plated	250	007412
Flat Washers DIN125-1 A M4 zinc-plated	200	007420
Flat Washers DIN125-1 A M5 zinc-plated	200	007439
Flat Washers DIN125-1 A M6 zinc-plated	150	007447

INTERNAL/Approved (2019-03-22 23:31:54)

Bera Clic cases system

Spare Parts	PU Piece	Article No.
BERA CLIC+ Cushion Lids	1	104057
BERA CLIC+ 18 in 1 Component Inlet	1	102576
BC+ system case sz. 1	1	102544

Hex Head Screws DIN 933 Galvanized M5/M6/M8/M10

- The assortment contains the most common hexagonal screws DIN 933 for motor-vehicle operation and assembly companies

Characteristics

- Steel screws sorted from 50x20 to 10x30

Title	PU Assortment	Article No.
BC+1 933ZP M5/M6/M8/M10	1	102756

AGR: 07.210

Scope Of Supply	Piece	Article No.
Hexagonal Screw DIN933 8.8 M10X20 zinc-plated	30	097691
Hexagonal Screw DIN933 8.8 M10X30 zinc-plated	30	097632
Hexagonal Screw DIN933 8.8 M5X20 zinc-plated	100	097250
Hexagonal Screw DIN933 8.8 M6X20 zinc-plated	100	097330
Hexagonal Screw DIN933 8.8 M6X25 zinc-plated	100	097349
Hexagonal Screw DIN933 8.8 M8X20 zinc-plated	50	097608
Hexagonal Screw DIN933 8.8 M8X25 zinc-plated	50	097489
Hexagonal Screw DIN933 8.8 M8X30 zinc-plated	50	097497

Spare Parts	PU Piece	Article No.
BERA CLIC+ Cushion Lids	1	104057
BERA CLIC+ 8 in 1 Component Inlet	1	102574
BC+ system case sz. 1	1	102544



Bera Clic+1 Security Elements

- The most important safety elements in a well-assorted trading system

Characteristics

- Nuts DIN 934 from M4 up to M12
- U-discs DIN 125 from M4 up to M12
- Spring washers DIN 127 from M4 up to M12

Title	PU Assortment	Article No.
BC+1 LOCK.ELEMENTS	1	102776
AGR: 07.210		
Scope Of Supply	Piece	Article No.
Hexagon Nuts DIN934 steel 8 M5 zinc-plated	250	004340
Hexagon Nuts DIN934 steel 8 M12 zinc-plated	25	004391
Spring Ring DIN127B M12 zinc-plated	100	003689
Hexagon Nuts DIN934 steel 8 M10 zinc-plated	50	004448
Hexagon Nuts DIN934 steel 8 M4 zinc-plated	250	004332
Hexagon Nuts DIN934 steel 8 M6 zinc-plated	250	004359
Hexagon Nuts DIN934 steel 8 M8 zinc-plated	125	004375
Spring Ring DIN127B M10 zinc-plated	100	003670
Spring Ring DIN127B M4 zinc-plated	500	003620
Spring Ring DIN127B M5 zinc-plated	500	003638
Spring Ring DIN127B M6 zinc-plated	200	003646
Spring Ring DIN127B M8 zinc-plated	200	003662
Flat Washers DIN125-1 A M10 zinc-plated	100	007471
Flat Washers DIN125-1 A M12 zinc-plated	100	632937
Flat Washers DIN125-1 A M4 zinc-plated	500	007420
Flat Washers DIN125-1 A M5 zinc-plated	500	007439
Flat Washers DIN125-1 A M6 zinc-plated	200	007447
Flat Washers DIN125-1 A M8 zinc-plated	200	007463



INTERNAL/Approved (2019-03-22 23:32:41)

Bera Clic cases system

Spare Parts	PU Piece	Article No.
BERA CLIC+ Cushion Lids	1	104057
BERA CLIC+ 18 in 1 Component Inlet	1	102576
BC+ system case sz. 1	1	102544

Bera Clic+1 Drilling Screws

- The practical self-tapping vice is ideal for the repair and the mounting in handwork, saves time and costs

Characteristics

- Self-taping screw sortet, oval heead + hexagonal head of 3.5x13 up to 4.8x19

Title	PU Assortment	Article No.
DRIVING	1	102781

AGR: 07.210

Scope Of Supply

	Piece	Article No.
Self-drilling Screw DIN7504 M3,5x13 zinc-plated PH 2	100	070018
Self-drilling Screw DIN7504K 4,8x16 zinc-plated	100	389730
Self-drilling Screw DIN7504 4,8x19 zinc-plated	100	242608
Self-drilling Screw DIN7504K 4,8x19 zinc-plated	100	829272
Self-drilling Screw DIN7504K 4,2x19 zinc-plated	100	389714
Self-drilling Screw DIN7504 3,5x16 zinc-plated	100	242560
Self-drilling Screw DIN7504 M3,9x13 zinc-plated PH 2	100	070019
Self-drilling Screw DIN7504 3,9x16 zinc-plated	100	168424
Self-drilling Screw DIN7504 3,9x19 zinc-plated	100	168432
Self-drilling Screw DIN7504 3,9x22 zinc-plated	100	168440
Self-drilling Screw DIN7504 3,9x25 zinc-plated	100	168459
Self-drilling Screw DIN7504 M3,9x32 zinc-plated PH 2	100	828404
Self-drilling Screw DIN7504 4,2x16 zinc-plated PH2	100	168467
Self-drilling Screw DIN7504 4,2x19 zinc-plated	100	163589
Self-drilling Screw DIN7504 4,2x22 zinc-plated	100	168483
Self-drilling Screw DIN7504 4,2x25 zinc-plated	100	168491
Self-drilling Screw DIN7504 4,2x32 zinc-plated	100	330272
Self-drilling Screw DIN7504 4,8x16 zinc-plated	100	242594



Bera Clic cases system

Spare Parts

	PU Piece	Article No.
BERA CLIC+ Cushion Lids	1	104057
BERA CLIC+ 18 in 1 Component Inlet	1	102576
BC+ system case sz. 1	1	102544

Bera Clic cases system

Bera Clic+1 Rivets

- The assortment of the most important blind rivets for motor vehicles and handicraft

Characteristics

- Blind rivets flat head sortet 3.2x6 up to 4x 12 + hand riveter

Title	PU Assortment	Article No.
BC+1 RIVET	1	102754

AGR: 07.210

Scope Of Supply	Piece	Article No.
Blind rivet flat head 3,2x6 copper/bronze	100	335923
Blind Rivets, Flat Round Head 4x14 Aluminium/Steel	100	010103
Blind Rivets, Flat Round Head 4x8 Aluminium/Steel	100	010073
Blind Rivets, Flat Round Head 4x10 Aluminium/Steel	100	010081
Blind Rivets, Flat Round Head 4x12 Aluminium/Steel	100	010090
Blind Rivets, Flat Round Head 3,2x10 Aluminium/Steel	100	131380
Blind Rivets, Flat Round Head 3,2x10 steel	100	131418
Blind Rivets, Flat Round Head 3,2x8 Aluminium/Steel	100	800622
Blind Rivets, Flat Round Head 3,2x8 steel	100	131417
Hand Rivet Pliers B 150 A	1	916004
Plumbing Rivets SP/II 3.2x6.3	100	802633
Plumbing Rivets SP/III 3.2x8	100	802640
Blind Rivets, Flat Round Head 3,2x6 Aluminium/Steel	100	800646
Blind Rivets, Flat Round Head 3,2x6 steel	100	131416

Spare Parts	PU Piece	Article No.
BERA CLIC+ Cushion Lids	1	104057
BERA CLIC+ 14 in 1 Component Inlet	1	102575
BC+ system case sz. 1	1	102544



Bera Clic+1 Color Nails

- Color-nails in different dimensions and color variations

Characteristics

- Color-nail-range assorted by colors

Title	PU Assortment	Article No.
BC+1 COLORNAILS	1	102753

AGR: 07.210

Scope Of Supply	Piece	Article No.
Colour Nails Countersunk Head 1,75x25 Ruster, steel laked	100	821481
Colour Nails Countersunk Head 1,75x32 White, steel laked	100	881904
Colour Nails Countersunk Head 1,75x40 Mahagony, steel laked	100	821566
Colour Nails Countersunk Head 1,75x40 Walnut Tree, steel laked	100	821597
Colour Nails Countersunk Head 1,75x40 Palisander, steel laked	100	821559
Colour Nails Countersunk Head 1,75x25 Walnut tree, steel laked	100	821450
Colour Nails Countersunk Head 1,75x25 Mahagony, steel laked	100	821467
Colour Nails Countersunk Head 1,75x25 Palisander, steel laked	100	821474
Colour Nails Countersunk Head 1,75x25 Pine, steel laked	100	821498
Colour Nails Countersunk Head 1,75x25 White, steel laked	100	881911
Colour Nails Countersunk Head 1,75x32 Ruster, steel laked	100	821542
Colour Nails Countersunk Head 1,75x32 Walnut Tree, steel laked	200	821528
Colour Nails Countersunk Head 1,75x40 White, steel laked	100	881898
Colour Nails Countersunk Head 1,75x32 Pine, steel laked	200	821535
Colour Nails Countersunk Head 1,75x40 Ruster, steel laked	100	821580

Spare Parts	PU Piece	Article No.
BERA CLIC+ Cushion Lids	1	104057
BERA CLIC+ 18 in 1 Component Inlet	1	102576
BC+ system case sz. 1	1	102544



Bera Clic cases system

Bera Clic+1 Tacking Hammer + Clip

- The assortment for fast clamping, packed in a Bera-clic + case size 1

Characteristics

- Hammer-type with the suitable staples (6x9)

Hints

- The case contains 50000 pc

Title	PU Assortment	Article No.
BC+1 TACKING HAMM+CLIPS	1	102755
AGR: 07.210		
Scope Of Supply	Piece	Article No.
Hammer Tacker B-HH-V9	1	114671
Spare Parts	PU Piece	Article No.
BC+ system case sz. 1	1	102544
BERA CLIC+ Cushion Lids	1	104057



Twist Drill BERA CLIC + Size 1 DIN 338 HSS Rolled



Title	PU Assortment	Article No.
BC+1 HSS DIN 338 ROLLER	1	102978
AGR: 07.210		
Scope Of Supply	Piece	Article No.
Twist drill bit DIN 338 STANDARDline HSS	10	008323
Twist drill bit DIN 338 STANDARDline HSS	10	008324
Twist drill bit DIN 338 STANDARDline HSS	10	008325
Twist drill bit DIN 338 STANDARDline HSS	10	008327
Twist drill bit DIN 338 STANDARDline HSS	5	008328
Twist drill bit DIN 338 STANDARDline HSS	5	008330
Twist drill bit DIN 338 STANDARDline HSS	5	008332
Twist drill bit DIN 338 STANDARDline HSS	5	008333
Twist drill bit DIN 338 STANDARDline HSS	5	008334
Twist drill bit DIN 338 STANDARDline HSS	3	008336
Twist drill bit DIN 338 STANDARDline HSS	3	008337
Twist drill bit DIN 338 STANDARDline HSS	3	008339
Twist Drill DIN 338 STANDARDline HSS	3	008340
Twist drill bit DIN 338 STANDARDline HSS	2	008341
Twist drill bit DIN 338 STANDARDline HSS	2	008342
Twist drill bit Standardline DIN 338 HSS RF 9,5 mm	2	008343

INTERNAL/Approved (2019-03-22 23:34:09)

Bera Clic cases system

Scope Of Supply	Piece	Article No.
Twist drill bit Standardline DIN 338 HSS RF 10 mm	2	008344
Twist drill bit Standardline DIN338 HSS RF 10,5 mm	2	008345
BC+ system case sz. 1	1	102544
BERA CLIC+ Cushion Lids	1	104057
BERA CLIC+ Inlet for Drills	1	102584

Bera Clic+1 Bits HSS Silver Top

- Handy, clear and practical, in the workshop as well as during assembly work

Title	PU Assortment	Article No.
BC+1 DRILL TOP SILVER 338 HSS	1	141407

AGR: 07.210

Scope Of Supply	Piece	Article No.
Twist Drill Bit TOPline DIN 338 HSS 2.0 mm silver	10	131249
Twist Drill Bit TOPline DIN 338 HSS 2.5 mm silver	10	131254
Twist Drill Bit TOPline DIN 338 HSS 3.0 mm silver	10	131259
Twist Drill Bit TOPline DIN 338 HSS 3.5 mm silver	10	131264
Twist Drill Bit TOPline DIN 338 HSS 4.0 mm silver	5	131269
Twist Drill Bit TOPline DIN 338 HSS 4.5 mm silver	5	131274
Twist Drill Bit TOPline DIN 338 HSS 5.0 mm silver	5	131279
Twist Drill Bit TOPline DIN 338 HSS 5.5 mm silver	5	131284
Twist Drill Bit TOPline DIN 338 HSS 6.0 mm silver	5	131289
Twist Drill Bit TOPline DIN 338 HSS 6.5 mm silver	3	131294
Twist Drill Bit TOPline DIN 338 HSS 7.0 mm silver	3	131299
Twist Drill Bit TOPline DIN 338 HSS 7.5 mm silver	3	131304
Twist Drill Bit TOPline DIN 338 HSS 8.0 mm silver	3	131309
Twist Drill Bit TOPline DIN 338 HSS 8.5 mm silver	2	131314
Twist Drill Bit TOPline DIN 338 HSS 9.0 mm silver	2	131326
Twist Drill Bit TOPline DIN 338 HSS 9.5 mm silver	2	131331
Twist Drill Bit TOPline DIN 338 HSS 10.0 mm silver	2	131339
Twist Drill Bit TOPline DIN 338 HSS 10.5 mm silver	2	131341



BC+1 Universal Cutter

- The most important universal cutters, sockets (SDS+, 6 square) as well as center drill for wood and stone in our practical case system.

Application Area

- The hole saw is applicable for solid wood, plywood, chipboards, acrylic glass, plastic, tiles (up to scratch hardness 6), plasterboard, gypsum block, ceramic plate, asbestos cement, solid brick, brick and sand-lime brick

Characteristics

- Versatile applicable set for the entire construction industry. Depending on the application, only one central drill must be changed.



Title	PU Assortment	Article No.
BC+1 UNIVERSAL CUTTER	1	102635
AGR: 07.210		
Scope Of Supply	Piece	Article No.
Universal Hole Saw Cutter 35 mm	1	724670
Universal Hole Saw Cutter 50 mm	1	724700
Universal Hole Saw Cutter 63 mm	1	724726
Universal Hole Saw Cutter 68 mm	1	724742
HOLE SAW UNI-CUTTER HM 74 MM	1	724750
U-cutter center drill for wood 7,4x109 mm	1	010645
U-cutter center drill for stone 8x120 mm	1	010646
Collet U-Cut for wood M6 118 mm	1	010644
Collet U-Cut. M16 118 mm SDS Plus	1	010641
Spare Parts	PU Piece	Article No.
BC+ system case sz. 1	1	102544
BERA CLIC+ Cushion Lids	1	104057
BERA CLIC+ Inlet for Cylinder Saw	1	102588

INTERNAL/Approved (2019-03-22 23:34:47)

Bera Clic cases system

Bera Clic+1 Compass Saws HSS

- The most important hole saws, adapter and guide drill in our practical case system

Application Area

- Usable for steel, copper, brass, bronze, aluminium, cast, plastic and wood

Characteristics

- Versatile applicable set for electrical installation and sanitary work, roofer, wood construction, switchgear construction, refrigeration engineer and climate technician.

Title	PU Assortment	Article No.
BC+1 HOLESAW HSS	1	103138

AGR: 07.210

Scope Of Supply

	Piece	Article No.
Guide drill for A4, Ø 6,35 mm	1	355836
HOLDING SHAFT A1 14- 30 MM	1	106574
Shank (complete), large A2 A2 32 - 152 mm	1	345431
HSS Bi-Metal Cylinder Saw 19 mm	1	345318
HSS Bi-Metal Cylinder Saw 22 mm	1	345326
HSS Bi-Metal Cylinder Saw 25 mm	1	345334
HSS Bi-Metal Cylinder Saw 32 mm	1	345342
HSS Bi-Metal Cylinder Saw 35 mm	1	345350
HSS Bi-Metal Cylinder Saw 40 mm	1	121975
HSS Bi-Metal Cylinder Saw 44 mm	1	345377
HSS Bi-Metal Cylinder Saw 51 mm	1	345385
HSS Bi-Metal Cylinder Saw 60 mm	1	412228
HSS Bi-Metal Cylinder Saw 67 mm	1	345415
HSS Bi-Metal Cylinder Saw 68 mm	1	374067
HSS BI METAL HOLE SAW 14 MM	1	167673
HSS BI METAL HOLE SAW 16 MM	1	173506
HSS Bi-Metal Cylinder Saw 83 mm	1	219592



Spare Parts

	PU Piece	Article No.
BERA CLIC+ Cushion Lids	1	104057
BERA CLIC+ Inlet for Cylinder Saw	1	102588
BC+ system case sz. 1	1	102544

BC+1 Hammer Drill Bit **ROCKbeaver** SDS-plus Assortment 5-14 mm - 40 pieces

Title	PU Assortment	Article No.
BC+1 ROCKbeaver SDS+ 5-16 mm Set - 40 pcs	1	242007

AGR: 07.210

Scope Of Supply

	Piece	Article No.
Hammer drill bit ROCKbeaver SDS-plus 5x50/115 mm	10	213458
Hammer drill bit ROCKbeaver SDS-plus 6x100/165 mm	10	213465
Hammer drill bit ROCKbeaver SDS-plus 8x100/165 mm	10	213479
Hammer drill bit ROCKbeaver SDS-plus 10x100/165 mm	5	213486
Hammer drill bit ROCKbeaver SDS-plus 12x100/165 mm	3	213494
Hammer drill bit ROCKbeaver SDS-plus 14x150/215 mm	1	213505
Hammer drill bit ROCKbeaver SDS-plus 16x200/270 mm	1	188154



Bera Clic cases system

Bera Clic+3 Joiner/Carpenter

- The most important objects you need in hand, systematically and with order.

Characteristics

- The BERA CLIC+ case size 3 contains the most important tools for everyday use in joiner business and carpentry business

Title	PU Assortment	Article No.
BC+3 JOINER/JOINER	1	103202
AGR: 07.212		
Scope Of Supply	Amount	Article No.
Screw driver 2K top PZ 1x80	1	218440
Screw driver 2K top PZ 2x100	1	218441
Screw driver 2K top PZ 3x150	1	218442
Locksmith's Hammer	1	244579
Heavy-Duty Combination Pliers „Combi-Max“ 180 mm	1	100534
Angle key set 9 pieces, TX, standard	1	200483
Twist Drill Bit Box 19 Part DIN 388 STANDARDline	1	008368
MAN.COUNTERSINK 18 MM	1	823263
Measuring Tape EG II NC without magnet 3m	1	097784
MORTISE CHISEL SET 2K 4PCS	1	-
Pincers,Titanium Finish, Dip-Insulated 250 mm	1	001347
Fine Saw, Straight 250 mm	1	106871
Bit-Box 1/4" Mix 10 pcs	1	219217
Water Level Topline 40 cm	1	113472
Spare Parts	PU Piece	Article No.
BERA CLIC+ 8 in 1 Component Inlet	1	102581
BC+ INLET TOOL / 4460A	1	102579
BC+ INLET TOOL COVER	1	106794
BC+ system case sz. 3	1	102546



Bera Clic+3 Electricity

- The most important objects you need in hand, systematically and with order.

Characteristics

- The BERA CLIC+ case size 3 contains the most important tools for everyday use in the field of electricians

Title	PU Assortment	Article No.
BC+3 ELECTRICAL	1	103203
AGR: 07.212		
Scope Of Supply	Piece	Article No.
Multitester LCD plus, Voltage Tester	1	-
VDE PLIERS SET 5PCS. 3K	1	188103
Tape Measure EG II NC "BERNER" 3m	1	049306
CABLE KNIFE 486001	1	103384
Water Level Topline 40 cm	1	113472
Steel Spatula 50 mm	1	170909
Machinist's Hammer Topline DIN 1041 300 g 6110/3	1	-
CABLE-PULL TAPE 10/4	1	137489
IN-PL-STRIPPER NO.13	1	814091
Plastic Inlay with VDE Screwdriver Set, Slotted and PH Head 7-part	1	-
Spare Parts	PU Piece	Article No.
BC+ INLET TOOL COVER	1	106794
BERA CLIC+ 8 in 1 Component Inlet	1	102581
BC+ INLET TOOL / 4460A	1	102579
BC+ system case sz. 3	1	102546



Bera Clic cases system

Bera Clic+1 Connector Insulated

- Pluggable electric connection for wires with different diameters

Characteristics

- Set of all common, insulated connectors

Title	PU Assortment	Article No.
BC+1 CONNECTOR INSUL	1	102849

AGR: 07.210

Scope Of Supply	Piece	Article No.
Insulated Connector 3119	100	012297
Insulated Connector 3111	100	012602
Insulated Connector 3102	100	012505
Insulated Connector 3118	100	012246
Insulated Connector 3320	100	012254
Insulated Connector 3330	100	012238
Insulated Connector 3503	100	012467
UNIVERSAL CRIMPING PLIER	1	201222
Insulated Connector 3301	100	012440
Insulated Connector 3302	100	012432
Insulated Connector 3303	100	012416
Insulated Connector 3313	100	012610
Insulated Connector 3321	100	012270
Insulated Connector 3514	50	012289

Spare Parts	PU Piece	Article No.
BERA CLIC+ Cushion Lids	1	104057
BERA CLIC+ 14 in 1 Component Inlet	1	102575
BC+ system case sz. 1	1	102544



Bera Clic+2 Cable Tie White

- For the fast bundling of wires, hoses and so on

Characteristics

- Cable tie selection in white design

Title	PU Assortment	Article No.
BC+2 CABLE TIE WHITE	1	103164
AGR: 07.211		
Scope Of Supply	Piece	Article No.
Cable Strap 150 x 3,6 mm natural	500	019739
Cable Strap 202 x 3,6 mm natural	500	019747
Cable Strap 286 x 4,8 mm natural	500	019755
Spare Parts	PU Piece	Article No.
BERA CLIC+ Cushion Lids	1	104057
Bera Clic+ system case sz. 2	1	102545



Bera Clic cases system

Bera Clic+2 cable Tie Black

- For the fast bundling of wires, hoses and so on

Characteristics

- Cable tie selection in black design

Title	PU Assortment	Article No.
BC+2 CABLE TIE BLACK	1	103179

AGR: 07.211

Scope Of Supply	Piece	Article No.
Cable Strap 102 x 2,5 mm black	300	930251
Cable Strap 150 x 3,6 mm black	500	772399
Cable Strap 202 x 3,6 mm black	500	182853
Cable Strap 286 x 4,8 mm black	500	113820

Spare Parts	PU Piece	Article No.
BERA CLIC+ Cushion Lids	1	104057
Bera Clic+ system case sz. 2	1	102545



Glazing Blocks

- Optimal water drainage by integrated aeration system

Application Area

- Glazing of wood, plastic and aluminum windows

Characteristics

- Color guide system for different thicknesses

Hints

- Complies with the HAGAMAR Guideline



Title	PU Assortment	Article No.
BERA-CLIC GLAZING BLOCKS	1	103144
AGR: 07.211		
Scope Of Supply	Piece	Article No.
Glazing Block white 24x1 mm	100	003230
Glazing Block blue 24x2 mm	200	003252
Glazing Block red 24 x3 mm	100	003253
Glazing Block yellow 24x4 mm	100	003254
Glazing Block green 24x5 mm	100	003256
Glazing Block black 24x6 mm	60	003257
6-way compartment divider for Bera-clic, size 2	1	-
Bera Clic+ system case sz. 2	1	102545
BERA CLIC+ Cushion Lids	1	104057

Bera Clic cases system

BERA CLIC+ 4-Way Insert, Sz. 2

Title	PU Piece	Article No.
BERA CLIC+ 4-Way Insert, Sz. 2	1	104134

AGR: 07.204

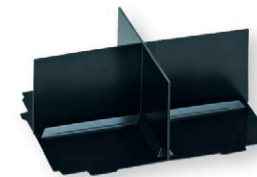

BERA CLIC+ 4-Way Insert, Sz. 3

Title	PU Piece	Article No.
BERA CLIC+ 4-Way Insert, Sz. 3	1	102582

AGR: 07.204



BERA CLIC+ 4-Way Insert, Sz. 4

Title	PU Piece	Article No.
BC+4-COMPT.-INSERT SZ.4/4507A	1	115700

AGR: 07.204



BERA CLIC+ 2-Component Inlet

Hints

- Inlett consists out of: 2 compartements with the dimensions 227 x 164 x 65 mm
- Stacking of the Inletts always with a stack inlet 8-fold inlet possible
- For example:
- BC+size2: 1 Inlett of coice + 1 stack inlet 8-fold Inlett
-
- BC+ Size 3: 1 Inlett of choice + 2 stack inlets 8-fold Inlett
-
- BC+ Gr. 4: 1 Inlett of choice + 3 stack inlets 8-fold Inlett.

Title	PU Piece	Article No.
BERA CLIC+ 2-Component Inlet	1	102566

AGR: 07.204

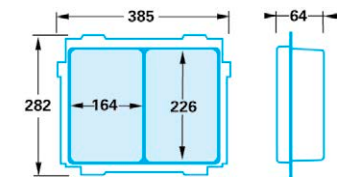

BERA CLIC+ 4 in 1 Component Inlet

Hints

- Inlett consists out of: 4 compartements with the dimensions 110 x 165 x 65 mm
- Stacking of the Inletts always with a stack inlet 8-fold inlet possible
- For example:
- BC+size2: 1 Inlett of coice + 1 stack inlet 8-fold Inlett
-
- BC+ Size 3: 1 Inlett of choice + 2 stack inlets 8-fold Inlett
-
- BC+ Gr. 4: 1 Inlett of choice + 3 stack inlets 8-fold Inlett.

Title	PU Piece	Article No.
BERA CLIC+ 4 in 1 Component Inlet	1	102567

AGR: 07.204

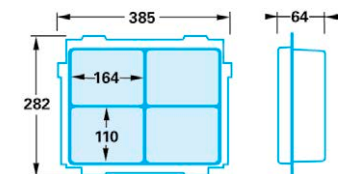
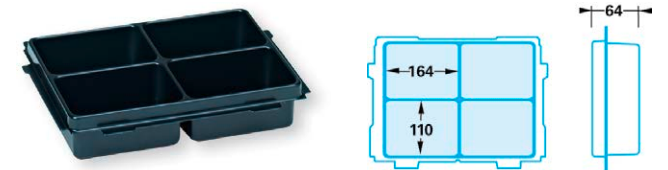

INTERNAL/Approved (2019-03-22 23:36:35)

Bera Clic cases system

BERA CLIC+ 5 in 1 Component Inlet

Hints

- Ticking consists of:
 - 1 compartment with the dimensions 228 x 108 x 65 mm
 - 1 compartment with the dimensions 126 x 108 x 65 mm
 - 1 compartment with dimensions 95 x 108 x 65 mm
 - 1 compartment with the dimensions 147 x 108 x 65 mm
 - 1 compartment with dimensions 74 x 108 x 65 mm

Title	PU Piece	Article No.
BERA CLIC+ 5 in 1 Component Inlet	1	102568
AGR: 07.204		

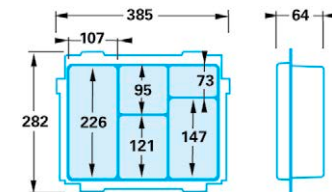

15

BERA CLIC+ 7 in 1 Component Inlet

Hints

- Inlett consists out of: 1 compartement with the dimensions 45 x 230 x 65 mm 4 compartments with the dimensions 74 x 110 x 65 mm 2 compartements with the dimensions 123 x 110 x 65 mm
- Stacking of the Inletts always with a stack inlet 8-fold inlet possible
- For example:
 - BC+size2: 1 Inlett of coice + 1 stack inlet 8-fold Inlett
 - BC+ Size 3: 1 Inlett of choice + 2 stack inlets 8-fold Inlett
 - BC+ Gr. 4: 1 Inlett of choice + 3 stack inlets 8-fold Inlett.

Title	PU Piece	Article No.
BERA CLIC+ 7 in 1 Component Inlet	1	102571
AGR: 07.204		

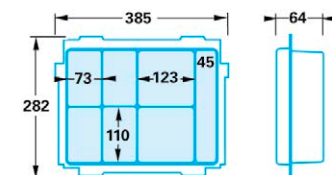

BERA CLIC+ 8 in 1 Component Inlet

Hints

- Inlett consists out of: 8 compartements with the dimensions 111 x 80 x 65 mm
- Stacking of the Inletts always with a stack inlet 8-fold inlet possible
- For example:
- BC+size2: 1 Inlett of coice + 1 stack inlet 8-fold Inlet
-
- BC+ Size 3: 1 Inlet of choice + 2 stack inlets 8-fold Inlett
-
- BC+ Gr. 4: 1 Inlett of choice + 3 stack inlets 8-fold Inlett.

Title	PU Piece	Article No.
BERA CLIC+ 8 in 1 Component Inlet	1	102574

AGR: 07.204

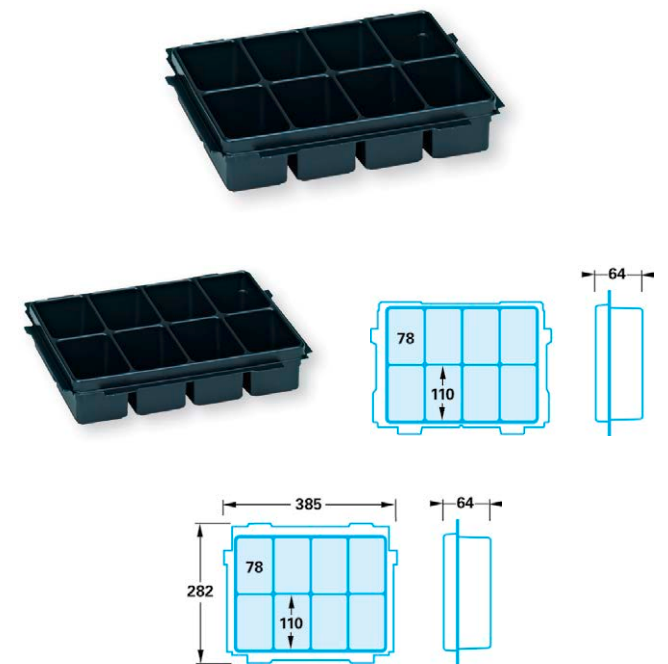

BERA CLIC+ 14 in 1 Component Inlet

Hints

- Inlett consists out of: 12 compartements with the dimensions 64 x 52 x 65 mm 1 compartement with the dimensions 90 x 279 x 65 mm 1 compartement with the dimensions 90 x 51 x 65 mm
- Stacking of the Inletts always with a stack inlet 8-fold inlet possible
- For example:
- BC+size2: 1 Inlett of coice + 1 stack inlet 8-fold Inlet
-
- BC+ Size 3: 1 Inlet of choice + 2 stack inlets 8-fold Inlett
-
- BC+ Gr. 4: 1 Inlett of choice + 3 stack inlets 8-fold Inlett.

Title	PU Piece	Article No.
BERA CLIC+ 14 in 1 Component Inlet	1	102575

AGR: 07.204

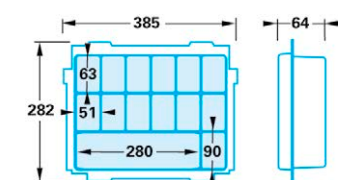

INTERNAL/Approved (2019-03-22 23:36:57)

Bera Clic cases system

BERA CLIC+ 18 in 1 Component Inlet

Hints

- Inlett consists out of: 18 compartements with the dimensions 73 x 52 x 65 mm
- Stacking of the Inletts always with a stack inlet 8-fold inlet possible
- For example:
- BC+size2: 1 Inlett of coice + 1 stack inlet 8-fold Inlet
-
- BC+ Size 3: 1 Inlet of choice + 2 stack inlets 8-fold Inlett
-
- BC+ Gr. 4: 1 Inlett of choice + 3 stack inlets 8-fold Inlett.

Title	PU Piece	Article No.
BERA CLIC+ 18 in 1 Component Inlet	1	102576

AGR: 07.204

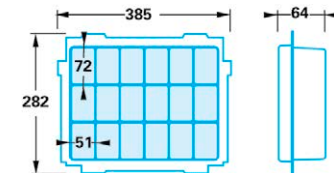

15

BERA CLIC+ Inlet for Drills

Hints

- Stacking of the Inletts always with a stack inlet 8-fold inlet possible
- For example:
- BC+size2: 1 Inlett of coice + 1 stack inlet 8-fold Inlet
-
- BC+ Size 3: 1 Inlet of choice + 2 stack inlets 8-fold Inlett
-
- BC+ Gr. 4: 1 Inlett of choice + 3 stack inlets 8-fold Inlett.

Title	PU Piece	Article No.
BERA CLIC+ Inlet for Drills	1	102584

AGR: 07.204

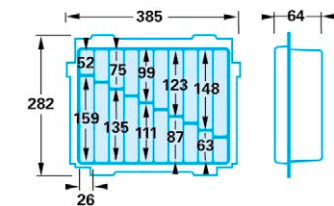

Bera Clic+ Inlett for drilling machine BRD-S / BRD-S-1

Hints

- Stacking of the Inletts always with a stack inlet 8-fold inlet possible
- For example:
- BC+size2: 1 Inlett of coice + 1 stack inlet 8-fold Inlet
-
- BC+ Size 3: 1 Inlet of choice + 2 stack inlets 8-fold Inlett
-
- BC+ Gr. 4: 1 Inlett of choice + 3 stack inlets 8-fold Inlett.

Title	PU Piece	Article No.
Bera Clic+ Inlett for Drilling machines	1	102578

AGR: 07.204

BERA CLIC+ Inlet for Angular / Eccentric Sander

Hints

- Stacking of the Inletts always with a stack inlet 8-fold inlet possible
- For example:
- BC+size2: 1 Inlett of coice + 1 stack inlet 8-fold Inlet
-
- BC+ Size 3: 1 Inlet of choice + 2 stack inlets 8-fold Inlett
-
- BC+ Gr. 4: 1 Inlett of choice + 3 stack inlets 8-fold Inlett.

Title	PU Piece	Article No.
BC+ INLET ANGLE/EXZ.SC / 4645A	1	102587

AGR: 07.204



Bera Clic cases system

BERA CLIC+ MULTICOMPOUND System for Inlet

Hints

- Stacking of the Inletts always with a stack inlet 8-fold inlet possible
- For example:
- BC+size2: 1 Inlett of coice + 1 stack inlet 8-fold Inlet
-
- BC+ Size 3: 1 Inlet of choice + 2 stack inlets 8-fold Inlett
-
- BC+ Gr. 4: 1 Inlett of choice + 3 stack inlets 8-fold Inlett.



Title	PU Piece	Article No.
BC+ INLETT MVS / 4633A	1	102563

AGR: 07.204

Bera Clic+ plastic half shell inletts 10,8/12 V cordless power tools

Title	PU Piece	Article No.
BC+ inlet consumables 10.8/12 V HS	1	243839
BC+ inlet 10.8/12 V empty space HS	1	243842

AGR: 07.204



Bera Clic+ Inlets 14,4 & 18 V Cordless Power Tools

Title	PU Piece	Article No.
BC+ Inlet several cordless drills 14,4&18V	1	186668
BC+ Midi Inlet Recipro saw BACRS 18 V	1	186673
BC+ Inlet Cordless Hammer BACRHD BL 18 V	1	333630
BC+ Inlet cordl angle grinder BACAG	1	187563
BC+ Inlet Cordl. Circular Saw BACCS 18 V	1	186670
BERA-clic+ Inlet cordl.hammer/505785	1	186672
BC+ Inlet Cordless Impact Wrench BACIW 18 V	1	186671
BC+ Inlett Impact wrench BACIW HP BL 18 V	1	367500

AGR: 07.204

Bera Clic+Inlet Tool/4460A

Title	PU Piece	Article No.
BC+ INLET TOOL / 4460A	1	102579

AGR: 07.204

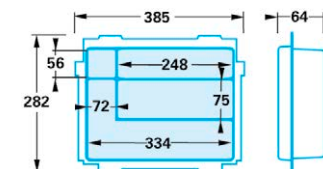

Bera Clic cases system

BERA CLIC+ Inlet for Cylinder Saw

Hints

- Stacking of the Inletts always with a stack inlet 8-fold inlet possible
- For example:
- BC+size2: 1 Inlett of coice + 1 stack inlet 8-fold Inlett
-
- BC+ Size 3: 1 Inlett of choice + 2 stack inlets 8-fold Inlett
-
- BC+ Gr. 4: 1 Inlett of choice + 3 stack inlets 8-fold Inlett.

Title	PU Piece	Article No.
BERA CLIC+ Inlet for Cylinder Saw	1	102588

AGR: 07.204



Bera Clic+Inlet Tool Cover

Title	PU Piece	Article No.
BC+ INLET TOOL COVER	1	106794

AGR: 07.204

BERA CLIC+ 8 in 1 Component Inlet

Hints

- Inlett consists out of: 4 compartement with the dimensions 111 x 121 x 50 mm 2 compartments with the dimensions 62 x 82 x 50 mm 2 compartements with the dimensions 44 x 82 x 50 mm
- Stacking of the Inletts always with a stack inlet 8-fold inlet possible
- For example:
- BC+size2: 1 Inlett of coice + 1 stack inlet 8-fold Inlett
-
- BC+ Size 3: 1 Inlett of choice + 2 stack inlets 8-fold Inlett
-
- BC+ Gr. 4: 1 Inlett of choice + 3 stack inlets 8-fold Inlett.

Title	PU Piece	Article No.
BERA CLIC+ 8 in 1 Component Inlet	1	102581

AGR: 07.204

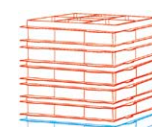
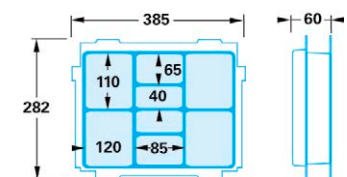

Bera Clic cases system

Bera Clic+4 Inlet Cans

Title	PU Piece	Article No.
BC+4 INLETT CANS AGR: 07.204	1	116760

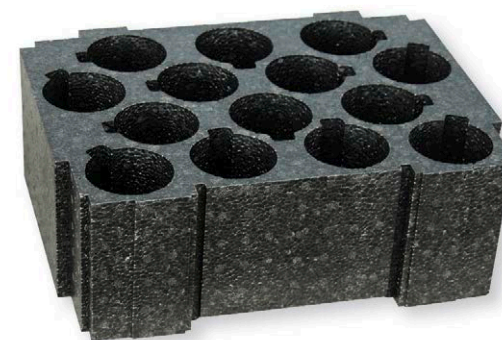

Bera Clic+ Cartridge Holder

Title	PU Piece	Article No.
BC+ CARTRIDGE INSERTER AGR: 07.204	1	115689



15

BERA CLIC+ OFFICE Lids

Hints

- Suitable for all BERA CLIC + Case

Title	PU Piece	Article No.
BERA CLIC+ OFFICE Lids AGR: 07.201	1	104060



INTERNAL/Approved (2019-03-22 23:38:06)

Bera Clic cases system

BERA CLIC+ floor panel

Title	PU Piece	Article No.
BC+EMPTY BASE PLATE AGR: 07.204	1	104125

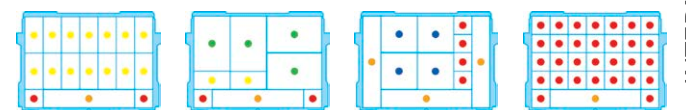

INTERNAL/Approved (2019-03-22 23:38:26)

BC+ Module Box BLUE

Title	Length x width x height	PU Piece	Article No.
BC+ BLUE MODULE CASE	98 x 98 x 71 mm	1	104115

AGR: 07.204

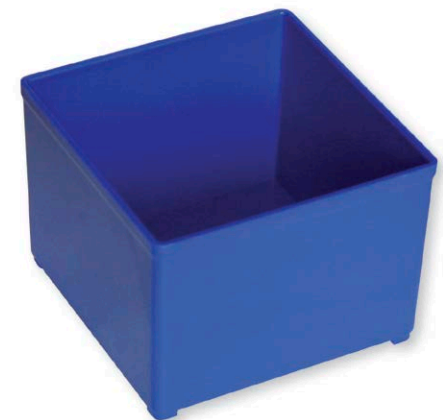
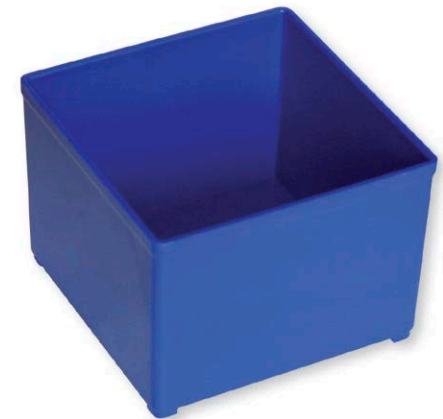

Bera Clic cases system**BC+ Module Box YELLOW**

Title	Length x width x height	PU Piece	Article No.
BC+ YELLOW MODULE CASE AGR: 07.204	49 x 98 x 71 mm	1	104094

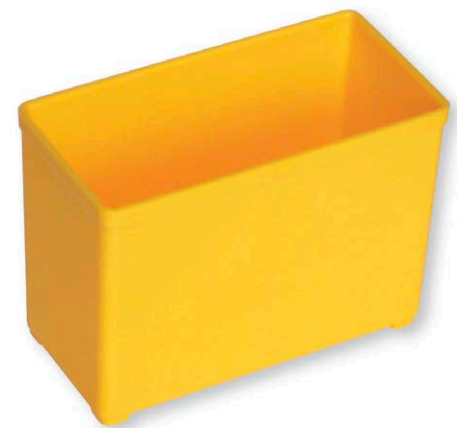
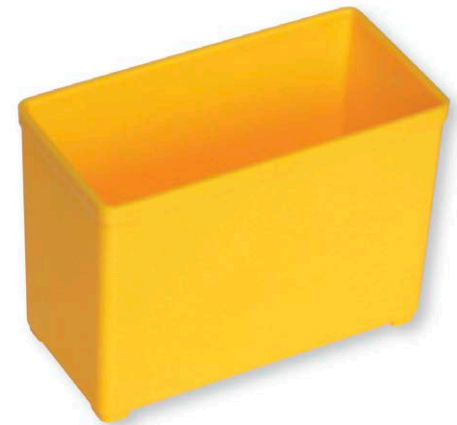

BC+ Module Box GREEN

Title	Length x width x height	PU Piece	Article No.
BC+ GREEN MODULE CASE	98 x 147 x 71 mm	1	104088

AGR: 07.204

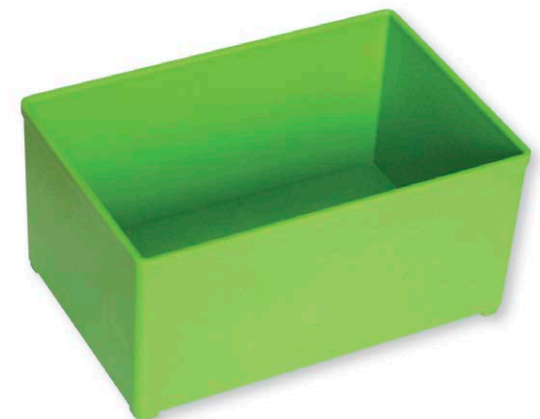
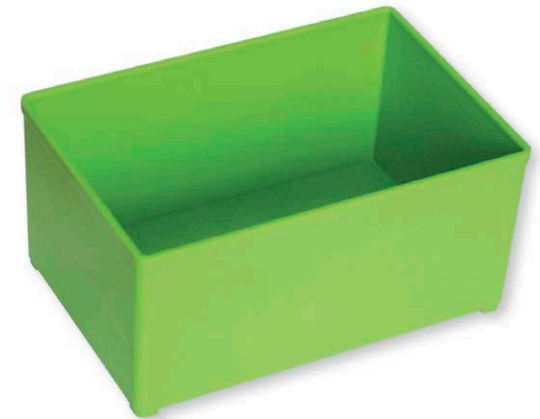

Bera Clic cases system**BC+ Module Box RED**

Title	Length x width x height	PU Piece	Article No.
BC+ RED MODULE CASE AGR: 07.204	49 x 49 x 71 mm	1	104116



BC+ Module Box ORANGE

Title	Length x width x height	PU Piece	Article No.
BC+ ORANGE MODULE CASE	49 x 245 x 71 mm	1	104124

AGR: 07.204

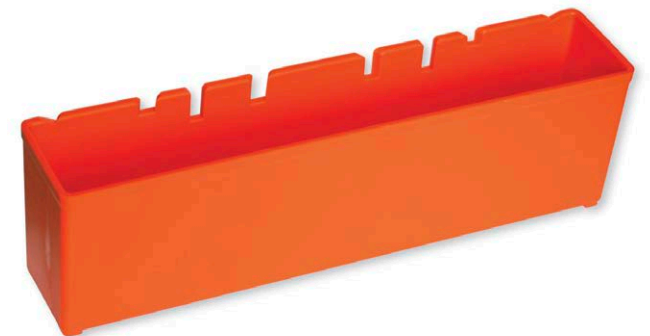
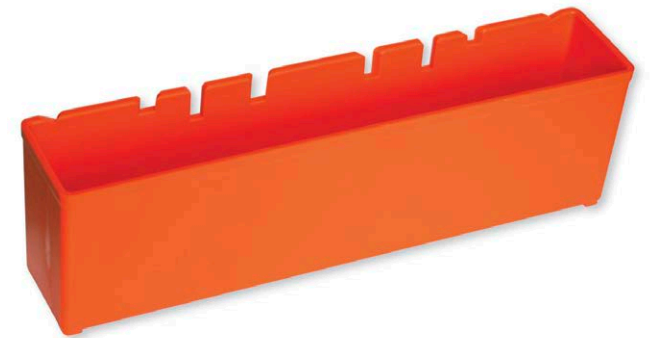

15

BERA CLIC+ system case sz. 1

Title	PU Piece	Article No.
Cover Pad EPP Module	1	104062

AGR: 07.201



INTERNAL/Approved (2019-03-22 23:38:59)

Bera Clic cases system

Small Safe Box

Characteristics

- Delivery:
Without mounting kit
without drawers

Processing Information

- Individuell combinable with the following hights:
- Bera CLIC+ size 1 120 mm
- Bera CLIC+ size 2 180 mm
- Bera CLIC+ size 3 245 mm
- Bera CLIC+ size 4 362 mm
- Bera CLIC+ size 5 470 mm

Hints

- The vehicle owner and the vehicle driver are responsible for the securing of loads: we therefore recommend to secure the Bera CLIC+ Safe with the appropriate mounting kit according to the instructions

Technical Data

Weight 18 kg

Title	Outside dimension W x H x D	PU Piece	Article No.
Small safe box	486 x 460 x 400 mm	1	167007

AGR: 07.207

Accessories Available	PU Piece	Article No.
BC+ DRAWER ELEMENT	1	104138

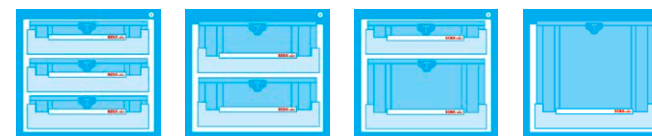

Safe Box BC large

- Safe and tidy storage of the Bera CLIC + case in a solid safe

Characteristics

- Delivery:
With mounting kit
without drawers

Processing Information

- Individuell combinable with the following heights:
- Bera CLIC+ size 1 120 mm
- Bera CLIC+ size 2 180 mm
- Bera CLIC+ size 3 245 mm
- Bera CLIC+ size 4 362 mm
- Bera CLIC+ size 5 470 mm

Hints

- The vehicle owner and the vehicle driver are responsible for the securing of loads: we therefore recommend to secure the Bera CLIC+ Safe with the appropriate mounting kit according to the instructions

Technical Data

Weight 27 kg

Title	Outside dimension W x H x D	PU Piece	Article No.
Large Safe Box	486 x 1000 x 400 mm	1	151535

AGR: 07.207

Accessories Available	PU Piece	Article No.
BC+ DRAWER ELEMENT	1	104138

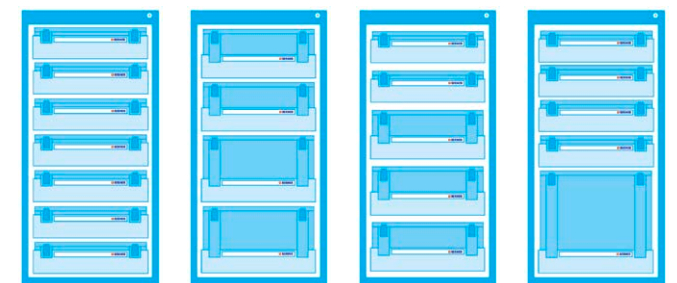

Fastening Set

Characteristics

- Excerpt: about 340 mm
Load capacity per drawer: 25kg

Title	PU Piece	Article No.
BC+ DRAWER ELEMENT AGR: 07.207	1	104138



BERA CLIC + Four-Way Floor Cushion

Title	PU Piece	Article No.
BERA CLIC + Four-Way Floor Cushion, 5 mm	1	104061

AGR: 07.201



BERA CLIC Rotation Lock

Title	PU Piece	Article No.
BERA CLIC+ Rotation Lock	1	104065

AGR: 07.201



Bera Clic cases system

Bera Clic Transport Caddy III

- Puncture-proof tires
- Folds to 55 mm thickness
- Suitable for the old and new BERA CLIC generation
- Stable by compact aluminum frame

Technical Data

Weight 4900 g

Title	External Width	Height, External	Depth, Exterior	PU Piece	Article No.
BERA CLIC TRANSPORT CADDY III	330 mm	1075 mm	510 mm	1	198500

AGR: 07.201



BERA CLIC+ Cube Cushion

Title	PU Piece	Article No.
BERA CLIC+ Cube Cushion	1	102562

AGR: 07.204

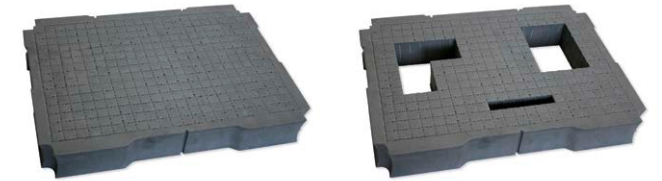

BERA CLIC+ Cushion Lids

Title	PU Piece	Article No.
BERA CLIC+ Cushion Lids	1	104057

AGR: 07.201



BERA CLIC+ Floor Cushion

Title	Height	PU Piece	Article No.
BERA CLIC+ Floor Cushion 25 mm	25 mm	1	103873

AGR: 07.201



Bera Clic cases system

BERA CLIC+ OFFICE Cushion

Hints

- suitable for BERA CLIC + Size: 2

Title	PU Piece	Article No.
BERA CLIC+ OFFICE Cushion AGR: 07.204	1	102561



BERA CLIC+ Napped Cover for Foam Material

Title	PU Piece	Article No.
BERA CLIC+ Napped Cover for Foam Material AGR: 07.201	1	104059

Rubber Roller Board for BERA-Clic

Title	PU Piece	Article No.
BERA-CLIC RET RUBB ROLL.BOARD AGR: 07.201	1	137150

Roller Board for Bera Clic+

- Load capacity up to 100 kg

Hints

- Suitable for all Bera Clic + Case size. 1-5

Technical Data

Weight	2.86 kg
Loading Capacity	100 kg
Material	ABS/EBS

Title	Length	Width	Height	PU Piece	Article No.
BERA-CLIC+ ROLL. BOARD	519 mm	365 mm	157 mm	1	200998

AGR: 07.201

BERA CLIC+ Pivot Pin

Title	PU Piece	Article No.
BERA CLIC Pivot Pin	1	104066

AGR: 07.201

Cover for Berabox

Title	PU Piece	Article No.
Cover for Berabox	1	332503

AGR: 07.011



Bera Clic cases system

BERA CLIC+ Front Carrying Handle

- Easy installation in labeling fields

Title	PU Piece	Article No.
Front Carrying Handle	1	104078

AGR: 07.201



Insert Box for storage box

Title	PU Piece	Article No.
Insert Box for storage box	1	341537
Operation box medium	1	341538
Operation box small	1	341539

AGR: 07.204



ACCESSORIES SET BC+ DRAWERS

- Set of 17 pcs - insert boxes and dividers of different sizes for Bera Clic+ drawers or Bera Clic+ Storage boxes
- 2x spacing foam for drawers, 4x insert boxes medium, 8x insert boxes small, 3x divider plates



Title	PU Piece	Article No.
ACCESSORIES SET BC+ DRAWERS	1	337800

AGR: 07.202

Module DIN and Standard Base Part

- Optimized for the storage of Berner DIN and standard parts
- 25 storage spaces
- Maximum flexibility due to slanted position and movable shelves and metal brackets

Application Area

- Clear arrangement and storage of small parts

Characteristics

- The optimal placement for an electrician

Scope Of Delivery

- 5 shelves
- 30 metal bracket
- 10 beams for the front and back
- 2 side support trusses
- 4 vertical bars
- 1 base

Technical Data

Material Sheet steel



Title	Height	Width	Depth	Color	PU Piece	Article No.
Module Din/Norm Lower part AGR: 07.001	1000 mm	542.5 mm	364 mm	Blue	1	094063

Module DIN and Standard Upper Part

- Optimized for the storage of Berner DIN and standard parts
- 25 storage spaces
- Maximum flexibility due to slanted position and movable shelves and metal brackets

Application Area

- Clear arrangement and storage of small parts

Scope Of Delivery

- 5 shelves
- 30 metal bracket
- 10 beams for the front and back
- 2 side support trusses
- 4 vertical bars
- 1 cover

Technical Data

Material Sheet steel



15

Title	Height	Width	Depth	Color	PU Piece	Article No.
Module Din/Norm Upper part	1000 mm	542.5 mm	364 mm	Blue	1	094065

AGR: 07.001

INTERNAL/Approved (2019-03-22 23:41:13)

Rack systems

Parts Shelving Tower DIN and Standard

- Preconfigured shelf tower for optimal storage of Berner DIN and standard parts
- 50 bins
- 10 shelves, each with 6 metal brackets
- Maximum flexibility by tilting and displaceability of all shelves and metal bracket
- Demand-driven assembly
- Space-saving storage
- Modular system for individual assembly and expansion options



Application Area

- Clear arrangement and storage of small parts

Characteristics

- Assembly package:
- Equipped with labeling, without shelf tower
- Regal Tower:
- Empty, without equipment, without labels, without storage boxes

Hints

- Delivery without storage boxes

Technical Data

Material Sheet steel

Title	Height	Width	Depth	Color	PU Piece	Article No.
STANDARD TOWER	2000 mm	542.5 mm	364 mm	Blue	1	094088*

* = The delivery time is 21 days

AGR: 07.001

Accessories Available

	PU Amount	Article No.
Storage Box blue Group 4	1	020033

Module Chemistry Bottom Part

- Optimized for the storage of Berner chemical cans and canister
- 18 storage spaces
- Maximum flexibility of all removable shelves and metal brackets

Application Area

- Clean and simple storage of items that are needed in everyday work.

Scope Of Delivery

- 3 shelves
- 21 metal bracket
- 6 traverses for Vorder and back
- 2 side support trusses
- 4 vertical bars
- 1 base

Technical Data

Material Sheet steel



Title	Height	Width	Depth	Color	PU Piece	Article No.
MODULE CHEMISTRY 1 AGR: 07.001	1000 mm	542.5 mm	364 mm	Blue	1	094066

Rack systems

Module Chemistry Upper Part

- Optimized for the storage of Berner chemical cans and canister
- 18 storage spaces
- Maximum flexibility of all removable shelves and metal brackets

Application Area

- Clean and simple storage of items that are needed in everyday work.

Processing Information

- Pro chemistry-shelf max. 25 kg

Hints

- Per chemical / DIN / norm-shelf max. 25 kg
Per base / lid max. 35 kg
Per drawer, max. 10 kg
Total load shelf filled (incl. Shelves and drawers) max. 250 kg

Scope Of Delivery

- 3 shelves
- 21 metal bracket 6 Tr
- 6 Taversen for front and rear
- 2 side support trusses
- 4 vertical bars
- 1 cover

Technical Data

Material Sheet steel

Title	Height	Width	Depth	Color	PU Piece	Article No.
MODULE CHEMISTRY 2 AGR: 07.001	1000 mm	542.5 mm	364 mm	Blue	1	094069



Shelving Tower for Chemicals

- Preconfigured shelf tower for optimal storage of chemicals Berner cans and bottles
- 42 storage spaces
- 6 brackets each with 7 metal temples
- Maximum flexibility due to movability of all shelves and metal brackets

Technical Data

Material Sheet steel



Title	Height	Width	Depth	Color	PU Piece	Article No.
CHEMISTRY TOWER	2000 mm	542.5 mm	364 mm	Blue	1	094089*

* = The delivery time is 21 days
AGR: 07.001

Bera Modul Tower Din/Norm u + Chemie o



15

Title	PU Piece	Article No.
Bera Modul Tower Din/Norm u + Chemie o	1	213646*

* = The delivery time is 21 days
AGR: 07.001

INTERNAL/Approved (2019-03-22 23:41:53)

Rack systems

Bera Modul Tower Din/Norm u + perforated plate



Title	PU Piece	Article No.
Bera Modul Tower Norm u + plate	1	213647*

* = The delivery time is 21 days
 AGR: 07.001

15

Bera Modul Tower Din/Norm u+ drawer



Title	PU Piece	Article No.
Bera Modul Tower Din/Norm u+ drawer	1	213648*

* = The delivery time is 21 days
 AGR: 07.001

Bera Modul Tower Din/Norm U + light cupboard



Title	PU Piece	Article No.
Bera Modul Tower Din/Norm U + light cupboard	1	213649*

* = The delivery time is 21 days

AGR: 07.001

BM Cartridge Dispenser

Technical Data

Material Sheet steel



15

Title	Height	Width	Depth	Color	PU Piece	Article No.
BM CARTRIDGE DISPENSER	292 mm	542.5 mm	364 mm	Blue	1	100111

AGR: 07.001

Lamps Module with DIN and Standard Parts, Upper Part

- 2 transparent drawers with each 5 variable dividers
- 3 shelves for storage of DIN and standard parts

Hints

- Per drawer, max. 10 kg
Per chemical / DIN / norm-shelf max. 25 kg
Per base / lid max. 35 kg
Total load shelf filled (incl. Shelves and drawers) max. 250 kg



Technical Data

Material Sheet steel

Title	Height	Width	Depth	Color	PU Piece	Article No.
MODULE w. drawers 2 PRT AGR: 07.001	1000 mm	542.5 mm	364 mm	Blue	1	094073

Rack systems

Module with 5 Drawers and Perforated Panel, Upper part

- 5 drawers which can be fitted with fits 10 Berner plastic inlets
- Perforated panel for individual use for all Berner holders
- Square holes for easy mounting of accessories

Application Area

- Clean and simple storage of items that are needed in everyday work

Technical Data

Material

Sheet steel



15

Title	Height	Width	Depth	Color	PU Piece	Article No.
MODULE DRAWERS AND PERF. PANEL	1000 mm	542.5 mm	364 mm	Blue	1	094075

AGR: 07.001

Module with 5 Drawers DIN and Standard Parts, Upper part

Technical Data

Material Sheet steel



15

INTERNAL/Approved (2019-03-22 23:42:38)

Title	Height	Width	Depth	Color	PU Piece	Article No.
MODULE DRAWER 5PRT D/S 2	1000 mm	542.5 mm	364 mm	Blue	1	094086

AGR: 07.001

Module with 5 Drawers and Chemistry, Upper Part

- Individual: By the simple plug-in system, the modules can be assembled according to customer requirements
- Modular design with modules defined for a variable storage solution
- Very robust due textured blue surface
- Space-saving storage
- Optimally aligned for Consumables
- Maximum flexibility by tilting and displaceability of all shelves and metal bracket
- Compact and stable: Modules (1000 x 542.5 x 364 mm) with cross members at the front and side for greater stability

Application Area

- Clean and simple storage of items that are used in daily work.

Characteristics

- Clear: The modules are specifically designed for forms of packaging and carton sizes. A clearly arranged and easy removal of the goods, optimal inventory control and maximum storage space utilization are guaranteed.

Technical Data

Material Sheet steel

Title	Height	Width	Depth	Color	PU Piece	Article No.
MODULE DRAWER CHEMISTRY 2	1000 mm	542.5 mm	364 mm	Blue	1	094087

AGR: 07.001



Module with 5 Drawers DIN and Standard Bottom Parts

Technical Data

Material Sheet steel



15

Title	Height	Width	Depth	Color	PU Piece	Article No.
Drawer module 5PRT with. D/S bottom part	1000 mm	542.5 mm	364 mm	Blue	1	094093

AGR: 07.001

INTERNAL/Approved (2019-03-22 23:42:56)

Rack systems

Bulbcabinet 1M

- Transparent plastic door
- lockable
- 4 shelves

Application Area

- Optimized for the storage of lamps
- Clean and simple storage of items that are needed in everyday work

Hints

- Per drawer, max. 10 kg
- Per chemical / DIN / norm-shelf max. 25 kg
- Per base / lid max. 35 kg
- Total load shelf filled (incl. Shelves and drawers) max. 250 kg

Technical Data

Material Sheet steel



Title	Height	Width	Depth	Color	PU Piece	Article No.
BULBCABINET 1M	1000 mm	542.5 mm	364 mm	Blue	1	094097
AGR: 07.001						

Shelving Tower Drawer with Lamp Module

- 8 shelves for optimal storage of Berner DIN and standard parts
- 2 transparent drawers with 5 variable dividers for optimum storage of Berner automobile lamps
- 40 storage spaces
- Maximum flexibility due to movability of all shelves and metal brackets

Technical Data

Material Sheet steel



Title	Height	Width	Depth	Color	PU Piece	Article No.
TOWER Module Drawers With Lamp	2000 mm	542.5 mm	364 mm	Blue	1	094090*

* = The delivery time is 21 days
AGR: 07.001

Rack systems

Threaded Rods Module

- Ideal for storing rods and profiles
- 10 divisions
- 1 tray for threaded rod parts
- Compact and stable

Application Area

- Clean and simple storage of items that are needed in everyday work

Technical Data

Material Sheet steel



15

Title	Height	Width	Depth	Color	PU Piece	Article No.
THREADED RODS MODULE AGR: 07.001	1000 mm	542.5 mm	364 mm	Blue	1	094094

INTERNAL/Approved (2019-03-22 23:43:24)

Universal Half-Height Module (500 mm)

- Use in restricted space
- 2 Universal shelves
- Very robust due textured blue surface
- Space-saving storage

Application Area

- Clean and simple storage of items that are needed in everyday work

Characteristics

- Clear: The modules are specifically designed for forms of packaging and carton sizes. A clearly arranged and easy removal of the goods, optimal inventory control and maximum storage space utilization are guaranteed.



Technical Data

Material Sheet steel

Title	Height	Width	Depth	Color	PU Piece	Article No.
MODULE UNIVERSAL 500mm	500 mm	542.5 mm	364 mm	Blue	1	094076

AGR: 07.001

Cabinet Module

- 4 adjustable shelves in 2 meter cupboard
- 2 adjustable shelves in 1 meter cupboard
- Door hinged left or right, reversible on (only for 2 meter cupboard)
- lockable

Technical Data

Material Sheet steel



Title	Height	Width	Depth	Color	PU Piece	Article No.
MODULE CABINET	2000 mm	542.5 mm	364 mm	Blue	1	094095

AGR: 07.001

Rack systems

Cover

Technical Data

Material Sheet steel



Title	Height	Width	Depth	Color	PU Piece	Article No.
MODULE COVER	25 mm	542.5 mm	364 mm	Blue	1	094077

AGR: 07.001

Bases

Technical Data

Material Sheet steel



Title	Height	Width	Depth	Color	PU Piece	Article No.
Base	25 mm	542.5 mm	364 mm	Blue	1	094078

AGR: 07.001

Lower Shelf DIN and Standard Parts

Scope Of Delivery

- Incl. 6 metal brackets for individual allocation

Technical Data

Material Sheet steel



Title	Height	Width	Depth	Color	PU Piece	Article No.
MODULE SHELF D/S	344 mm	542.5 mm	364 mm	Blue	1	094079

AGR: 07.001

Lower Shelf Chemistry

Scope Of Delivery

- Incl. 7 metal brackets for individual allocation



Technical Data

Material Sheet steel

Title	Height	Width	Depth	Color	PU Piece	Article No.
MODULE SHELF CHEMISTRY	344 mm	542.5 mm	364 mm	Blue	1	094080

AGR: 07.001

Perforated Plate for Side-Mounting

- Quadratic holes guarantee an easy assembly of all Berner holders
- For lateral mounting on each individual Bera module

Technical Data

Material	Sheet steel
Color	Blue

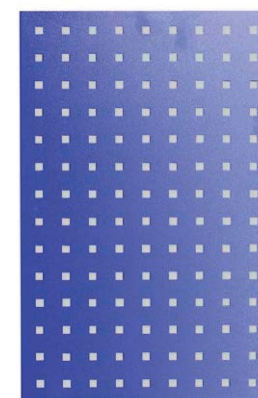
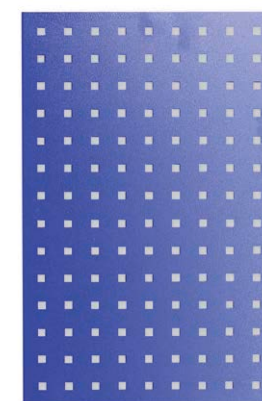
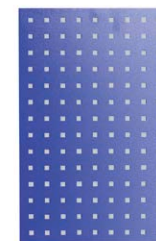

15

Title	Length	Width	Thickness	PU Piece	Article No.
MODULE PERF. PLATE SIDE AGR: 07.001	536 mm	341 mm	15 mm	1	094081

Sandpaper Dispenser, 1-Way

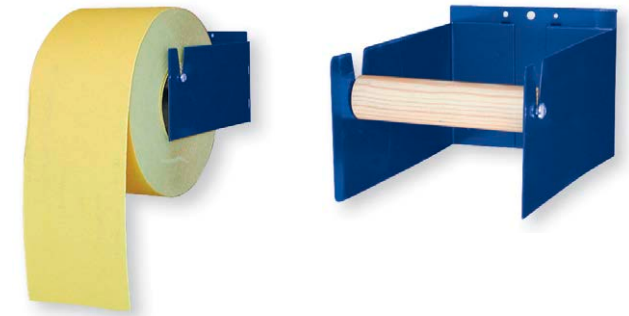

Title	Height	Width	Depth	PU Piece	Article No.
Sandpaper Dispenser, 1-Way	104.5 mm	125.5 mm	198 mm	1	100104

AGR: 07.001

Abrasive Cloth Dispensers, 1-Way /3-way

Technical Data

Material -

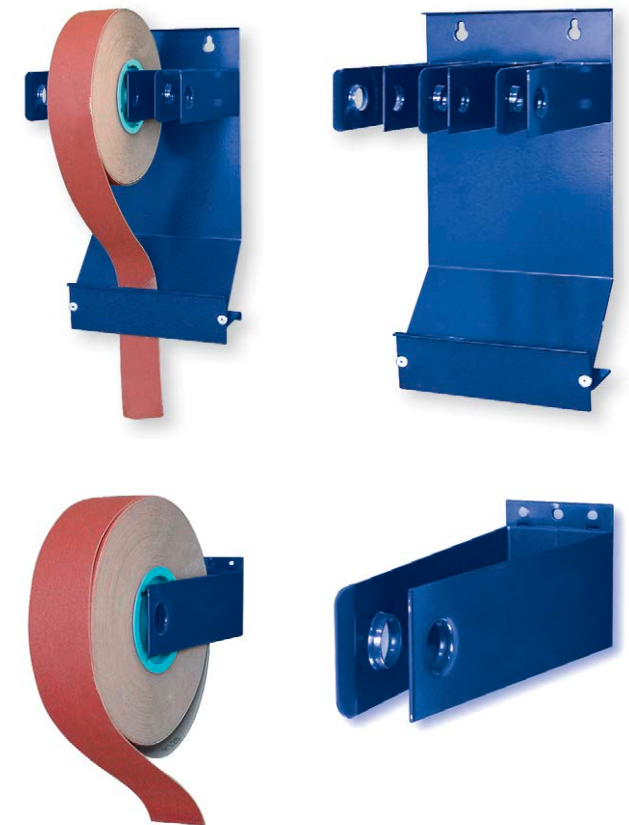

15

Title	Height	Width	Depth	PU Piece	Article No.
Abrasive Cloth Dispensers	380 mm	206 mm	199 mm	1	100099

AGR: 07.001

INTERNAL/Approved (2019-03-22 23:44:11)

Rack systems

Cable Dispenser, 1-Way/ 5-fach

Technical Data

Material

Sheet steel

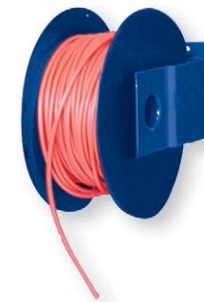

15

Title	Height	Width	Depth	PU Piece	Article No.
Cable Dispenser, 5-Way AGR: 07.001	105 mm	440 mm	121 mm	1	100080

INTERNAL/Approved (2019-03-22 23:44:29)

Montage Accessory

Technical Data

Material Steel

Title	Height	Width	Depth	PU Amount	Article No.
Bera Module Wall Mounting Set	-	-	-	1	100133
Bera Module Wall Mounting Set	-	-	-	1	100170
X-bracing Bera Module	-	-	-	1	120023
Company nameplate, top	160 mm	542.5 mm	50 mm	1	100923

AGR: 07.001

MAGNETIC LABEL

Title	Width x Length	Thickness	PU Piece	Article No.
81	25 x 81 mm	1 mm	10	239804

AGR: 90.020



15

Bera Modul Tower Din/Norm o+ Chemie u



Title	PU Piece	Article No.
Bera Modul Tower Din/Norm o+ Chemie u	1	213710*

* = The delivery time is 21 days

AGR: 07.001

INTERNAL/Approved (2019-03-22 23:44:31)

Rack systems

Bera Modul Tower Chemie u+Lamp Din/Norm o



Title	PU Piece	Article No.
Bera Modul Tower Chemie u+Lamp Din/Norm o	1	213712*

* = The delivery time is 21 days

AGR: 07.001

15

Bera Modul Tower Chemie u+ drawer perf. plate o



Title	PU Piece	Article No.
Bera Modul Tower Chemie u+ drawer plate	1	213714*

* = The delivery time is 21 days

AGR: 07.001

Bera Modul Tower Chemie +drawer Din/Norm o



Title	PU Piece	Article No.
Bera Modul Tower Chemie +drawer Din/Norm o	1	213715*

* = The delivery time is 21 days
 AGR: 07.001

Bera Modul Tower Chemie U+Lamp case



15

Title	PU Piece	Article No.
Bera Modul Tower Chemie U+Lamp case	1	213716*

* = The delivery time is 21 days
 AGR: 07.001

INTERNAL/Approved (2019-03-22 23:44:55)

Rack systems

Bera Modul Tower Din/Norm U+O



Title	PU Piece	Article No.
Bera Modul Tower Din/Norm U+O	1	213723*

* = The delivery time is 21 days

AGR: 07.001

15

Bera Modul Tower drawer Din/Norm o+ Chemie U



Title	PU Piece	Article No.
Bera Modul Tower drawer Din/Norm o+ Chemie U	1	213724*

* = The delivery time is 21 days

AGR: 07.001

Bera Modul Tower drawer Din/Norm u + lamp o



Title	PU Piece	Article No.
Bera Modul Tower drawer Din/Norm u + lamp o	1	213725*

* = The delivery time is 21 days
 AGR: 07.001

Bera Modul Tower Drawer Din/Norm u+ drawer perforated pl. o



Title	PU Piece	Article No.
Bera Modul Tower Drawer Din/Norm u+ drawer	1	213726*

* = The delivery time is 21 days
 AGR: 07.001

INTERNAL/Approved (2019-03-22 23:45:09)

Rack systems

Bera Modul Tower drawer Din/Norm u+o



Title	PU Piece	Article No.
Bera Modul Tower drawer Din/Norm u+o	1	213727*

* = The delivery time is 21 days
 AGR: 07.001

15

Bera Modul Tower drawer Din/norm u+ lamp-cupboard o



Title	PU Piece	Article No.
Bera Modul Tower drawer norm u + cupboard	1	213728*

* = The delivery time is 21 days
 AGR: 07.001

FRAME F. BERA MOD. ABOVE

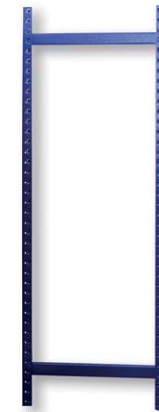

15

Title	PU Piece	Article No.
Frame for BERA module	1	341535
Frame for BERA module	1	341536

AGR: 07.001

Scanner Powerline ECCO Lite

Title	PU Piece	Article No.
Scanner Powerline ECCO Lite	1	339302

AGR: 07.002



INTERNAL/Approved (2019-03-22 23:45:26)

BL4 Chemistry Shelf

Technical Data

Material Sheet steel

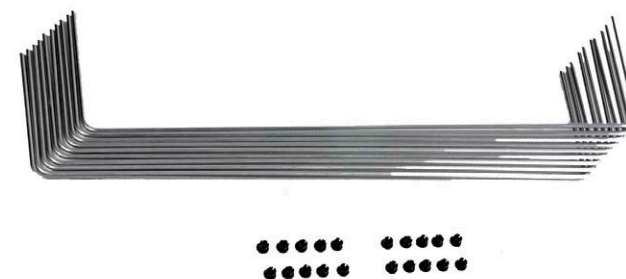

15

INTERNAL/Approved (2019-03-22 23:45:36)

Title	Height	Width	Depth	PU Piece	Article No.
BL4SYSTEM-SHELF CHEMISTRY UNIT	1000 mm	395 mm	725 mm	1	116950

AGR: 07.001

Spare Parts

	PU Piece	Article No.
B-SYST-SHELF CHEMIST CLASSIF	1	124462

BL 9 - Drawer Closed

Technical Data

Material Sheet steel



15

Title	PU Piece	Article No.
DRAWER CAB.-INSERT BLUE AGR: 07.001	1	158904

INTERNAL/Approved (2019-03-22 23:45:39)

BL3 Drawer Shelf

Technical Data

Material Sheet steel



15

Title	Height	Width	Depth	PU Piece	Article No.
BL3 SYSTEM-SHELF (4 DRAWER)	1000 mm	395 mm	720 mm	1	121858

AGR: 07.001

BL 80 System Shelf Cabinet

Technical Data

Material Sheet steel



INTERNAL/Approved (2019-03-22 23:45:53)

Title	Height	Width	Depth	PU Piece	Article No.
SYSTEM SHELF CABINET	1000 mm	395 mm	720 mm	1	168533
BL 80 SYSTEM SHELF CABINET 2 M	2000 mm	395 mm	720 mm	1	061792

AGR: 07.001

BL95 Cartridge Dispenser

15

Title	PU Piece	Article No.
BL 95 CATRIDGE HOLDER	1	061801
AGR: 07.001		

BL16 perforated plate for BERA rack system

Technical Data

Material Sheet steel

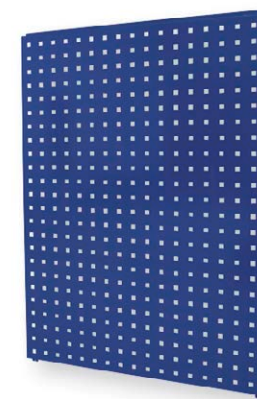
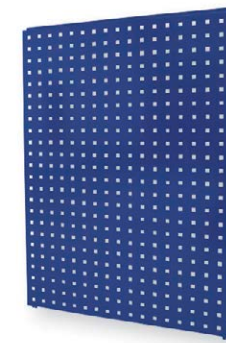

Title	Length	Width	PU Piece	Article No.
SYSTEM SHELF PERF.WALL LARGE	1000 mm	720 mm	1	168534

AGR: 07.001

Rack systems

BL22 Laterally Die Plate

Technical Data

Material Sheet steel



15

Title	PU Piece	Article No.
BL22 APERTURE PL SIDE AGR: 07.001	1	173209

INTERNAL/Approved (2019-03-22 23:46:14)

BL84 Universal Perforated Wall



15

Title	PU Piece	Article No.
BL 84 UNI-APERTURE PL SIDE	1	061797

AGR: 07.001

INTERNAL/Approved (2019-03-22 23:46:17)

Rack systems

System Shelf

Technical Data

Material Sheet steel



15

Title	Height	Width	PU Piece	Article No.
SYSTEM SHELF SIDE PART	1000 mm	400 mm	1	168543

AGR: 07.001

BL 25 - Traverses for Shelving System

Technical Data

Material Sheet steel



Title	Width	PU Piece	Article No.
BERNER-SYSTEM-SH COMP.SHELF	660 mm	1	124465

AGR: 07.001

INTERNAL/Approved (2019-03-22 23:46:26)

BL24 Lower Shelf Single

Technical Data

Material Sheet steel

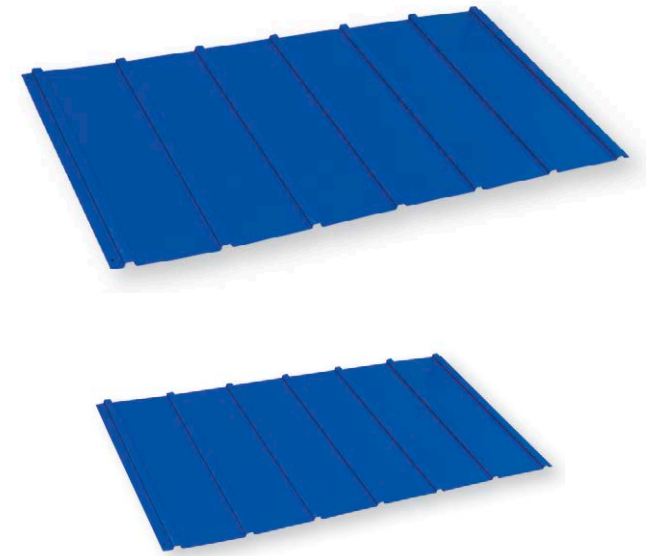

Title	PU Piece	Article No.
B-SYST-SHELF CHEMISTRY BASE AGR: 07.001	1	124464

15

BL26 Chemistry Bottom Single

Technical Data

Material Sheet steel



Title	PU Piece	Article No.
CR.MEMBER B- SYSTEM-SH 2PCS AGR: 07.001	1	124463

INTERNAL/Approved (2019-03-22 23:46:31)

BL21 Corner Shelf Complete

Technical Data

Material Sheet steel



15

Title	PU Piece	Article No.
BL21 CORNER SHELF COMPL. AGR: 07.001	1	173208

INTERNAL/Approved (2019-03-22 23:46:42)

BL 38 Set For Cable Ties



Title	PU Piece	Article No.
BL 38 BOX FOR CABLE TIES	1	061806
AGR: 07.001		

INTERNAL/Approved (2019-03-22 23:46:46)

BL 103 Balancing Weights



15

Title	PU Piece	Article No.
BL 103 SHELF BALANCE WEIGHTS	1	061810
AGR: 07.001		

INTERNAL/Approved (2019-03-22 23:46:53)

Unwinder

Technical Data

Material Sheet steel

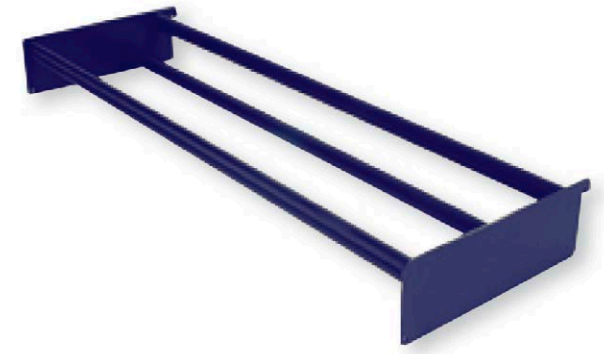

Title	Width	PU Piece	Article No.
ROLLER HOLDER 70 CM AGR: 07.003	700 mm	1	976562

BL33 Roll Holder For 2 Rolls



15

Title	PU Piece	Article No.
BL 33 ROLL HOLDER FOR 2 ROLLS	1	061795
BL 34 ROLL HOLDER FOR 3 ROLLS	1	061796

AGR: 07.001

INTERNAL/Approved (2019-03-22 23:47:04)

BL7 Roll Holder

Application Area

- suitable for cable reels, hose reels,...

Processing Information

- Wall mounting

Scope Of Delivery

- 2 x rod holder
- 1 x rod 1360 mm



Title	PU Piece	Article No.
ROLL HOLD.F SEAT GUI+FOOTMATS	1	144715
AGR: 07.031		

BL30 Shelf Label Berner

Hints

- Mounting material included

Technical Data

Material	Sheet steel
----------	-------------

Title	Width x Length	Thickness	PU Piece	Article No.
SYSTEM SHELF BERNER-MARK	160 x 725 mm	55 mm	1	168539
AGR: 07.001				



Rack systems

Hook Set

- contains the most important hooks and brackets

Application Area

- offers an optimal classification system for tools,...

Scope Of Delivery

- 7x BL 50 - hook 1-30-00
- 3x BL 51 - hook 1-60-00
- 1x BL 52 - hook 1-90-00
- 1x BL 55 - hook 3-25-00
- 1x BL 56 - hook 3-50-00
- 1x BL 58 - hook 4-40-35
- 1x BL 60 - hook 5-17-35
- 4x BL 62 - hook 6-12-00 (Ø 12 mm)
- 9x BL 63 - hook 6-18-00 (Ø 18 mm)
- 3x BL 64 - hook 6-24-00 (Ø 24 mm)



Title	PU Assortment	Article No.
LWH PERF.WALL HOOK RANGE AGR: 07.114	1	151358

BL50 Hook

Title	Width	PU Piece	Article No.
LWH PERF.WALL HOOK 1-60-00	-	1	029769
LWH PERF.WALL HOOK 1-30-00	30 mm	1	029768
LWH PERF.WALL HOOK 1-90-00	90 mm	1	029770

AGR: 07.114

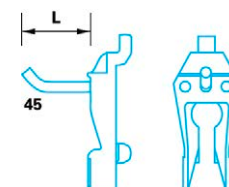

BL53 Hook

Title	Width	PU Piece	Article No.
LWH PERF.WALL HOOK 2-30-11	30 mm	1	029771
LWH PERF.WALL HOOK 2-60-11	60 mm	1	029772

AGR: 07.114

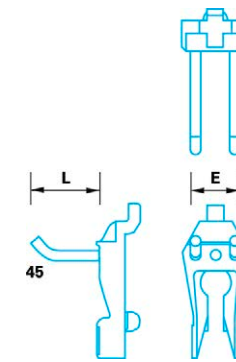

BL55 Hook

Title	Width	PU Piece	Article No.
LWH PERF.WALL HOOK 3-25-00	25 mm	1	029773
LWH PERF.WALL HOOK 3-50-00	50 mm	1	029774
LWH PERF.WALL HOOK 3-75-00	75 mm	1	029775

AGR: 07.114

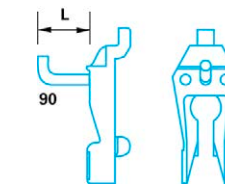

BL58 Hook

Title	Width	PU Piece	Article No.
LWH PERF.WALL HOOK 4-50-40	50 mm	1	029777

AGR: 07.114

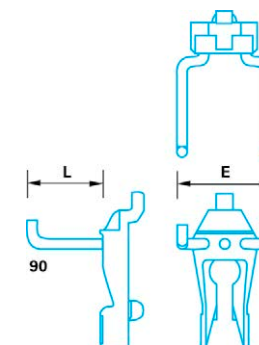

BL61 Hook

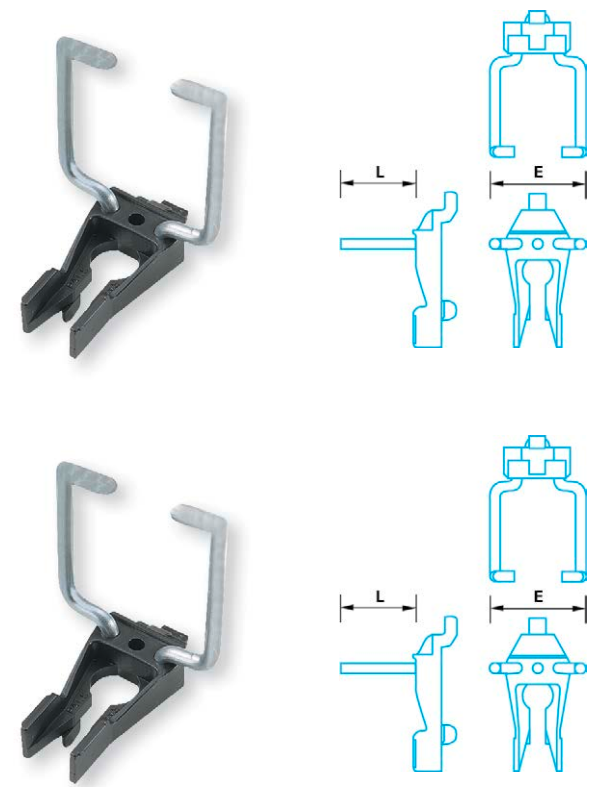

15

Title	Width	PU Piece	Article No.
LWH PERF.WALL HOOK 5-20-55 AGR: 07.114	20 mm	1	029779

BL62 Hook

Title	Ø	PU Piece	Article No.
LWH PERF.WALL HOOK 6-24-00 AGR: 07.114	24 mm	1	029782

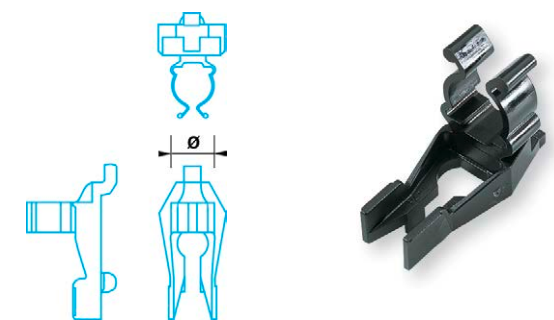

INTERNAL/Approved (2019-03-22 23:47:47)

Barrel Rack - single article

- TÜV-tested collection basin protects the floor from soiling
- No tipping or positioning of the drums required
- Stable execution

Application Area

- Safe storage of up to 2 60 liter barrels

Hints

- Capacity: approx. 70 liters

Technical Data

Material Steel



Title	Height	Width	Depth	Color	PU Piece	Article No.
TÜV approved catch basin	275 mm	395 mm	850 mm	-	1	102445
Barrel rack shelf	1210 mm	490 mm	640 mm	Blue	1	104133

AGR: 07.001

INTERNAL/Approved (2019-03-22 23:47:52)

Shelf N 8 D

- Storage boxes made of impact and break-proof plastic

Application Area

- Storage of small parts in narrow conditions

Characteristics

- Shelf N 8 D, empty: (Steel shelf for individual furnishing with up to 72 storage boxes size 4,
- Shelf N 8 D, furnished: Steel shelf, furnished with 72 storage boxes size 4)

Scope Of Delivery

- 8 single ledges (BS 1294) and 1 support ledge
- Mounting set consisting of: 4 x nylon dowel M 10 x 50
- 4 x hex head wood screws DIN 571 M 8 x 80



Technical Data

15

Material Sheet steel

Title	Height	Width	Color	PU Piece	Article No.
Shelf N 8 D empty	908 mm	1020 mm	Anthracite	1	232912
Shelf N 8 D furnished	908 mm	1020 mm	Anthracite	1	232580

AGR: 07.000

Shelf N 15 ED

Application Area

- Storage of small parts in narrow place conditions

Characteristics

- Shelf N 15 ED, empty: Steel shelf for individual furnishing with up to 63 storage boxes (size 4) and 30 storage boxes (size 3). Shelf N 15 ED, furnished: Steel shelf, furnished with 63 storage boxes (size 4) and 30 storage boxes (size 3)

Scope Of Delivery

- 7 single strips (BS 1294), 5 single strips (BS 1293) and 1 support rail
- Mounting kit consisting of: 4 x nylon dowel M 10 x 50
- 4 x hex head wood screws DIN 571 M 8 x 80

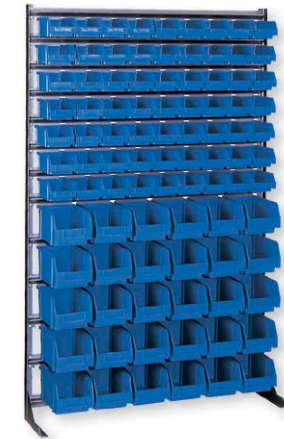

Technical Data

Material	Steel
----------	-------

Title	Height	Width	Color	PU Piece	Article No.
Shelf N 15 ED empty	1590 mm	1020 mm	Anthracite	1	232920
Shelf N 15 ED furnished	1590 mm	1020 mm	Anthracite	1	232602

AGR: 07.000

Bera Shelf BS 1201, without Boxes

Characteristics

- BS 1201, empty: Steel shelf for individual placement with up to 72 Mini Bera boxes (BS 1905) or 72 Midi Bera boxes (BS 1904)
- BS 1200, equipped: Steel shelf BS 1201, equipped with 72 Midi Bera boxes (BS 1904), blue color

Scope Of Delivery

- 8 single ledges (BS 1294) and 1 supporting ledge

Technical Data

Material Sheet steel



Title	Height	Width	Color	PU Piece	Article No.
Bera shelf BS 1200, equipped	1150 mm	1020 mm	Anthracite	1	310433
Bera shelf BS 1201, empty	1150 mm	1020 mm	Anthracite	1	310468

AGR: 07.000

Bera Shelf BS 1251 without Boxes

Characteristics

- BS 1251, empty: Steel shelf for individual furnishing with up to 63 Midi Bera boxes (BS 1904) or 63 Mini Bera boxes (BS 1905) and 30 Maxi Bera boxes (BS 1903)
- BS 1250, furnished: Steel shelf BS 1251, furnished with 63 midi Bera boxes (BS 1904) and 30 Bera boxes (BS 1903), blue color

Scope Of Delivery

- 7 single ledges (BS 1294), 5 single ledges (BS 1293) and 1 support ledge

Technical Data

Material Steel

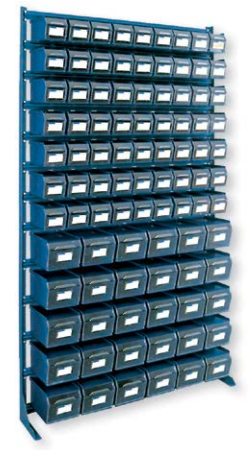

Title	Height	Width	Color	PU Piece	Article No.
Bera Shelf BS 1251, empty	1770 mm	1020 mm	Anthracite	1	310476

AGR: 07.000

Rack systems

Single Ledges

- Dust-free storage of small parts
- removal friendly
- Shatterproof
- Versatile variability

Characteristics

- BS 1293: for the accommodation of 6 storage boxes (size 3) resp. 6 Maxi Bera boxes (BS 1903), BS 1294: for the accommodation of 9 storage boxes (size 4/5) resp. 9 Mini Bera boxes (BS 1905) or Midi (BS 1904)

Hints

- Delivery without mounting kit

Title	Width	Color	PU Piece	Article No.
Single Ledges	1020 mm	Anthracite	1	310840
Single Ledges	1020 mm	Anthracite	1	310859

AGR: 07.001

Perforated Panels

- 4 grid sizes of high strength special steel enable a systematical order
- Square perforation for vertical and horizontal mounting, thus best use of existing surface
- Beveled all over and with strong beams stiffened for highest loads
- Blue stove-enamelled (RAL 5002)

Hints

- Perforated panel system provides for any tool and any part of the right holder
- Holders hook into the square perforation easily and screw in tightly

Technical Data

Material Sheet steel

Title	Length	Width	Perforation	Hole Distance Middle-Middle	PU Piece	Article No.
Perforated Panels	500 mm	450 mm	10 mm	38 mm	1	266230
Perforated Panels	1000 mm	450 mm	10 mm	38 mm	1	195812
Perforated Panels	1500 mm	450 mm	10 mm	38 mm	1	197017
Perforated Panels	2000 mm	450 mm	10 mm	38 mm	1	194883

AGR: 07.100

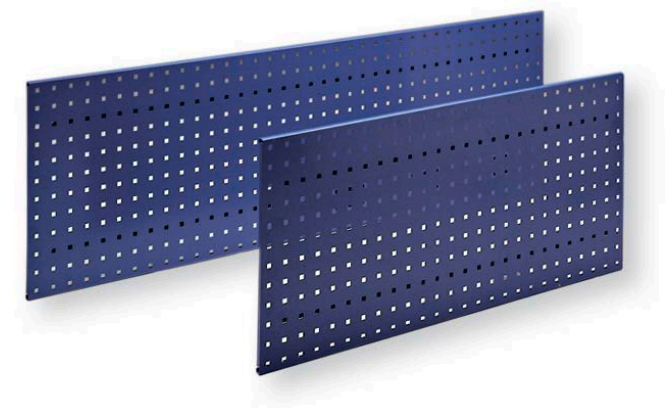

Peg-board systems

Holder 1 Single

Characteristics

- Single, angled hook end

Hints

- All holders are able to easily hook into the perforated wall holes and screw in tightly



Title	Length	Ø	PU Piece	Article No.
Holder 1/50	50 mm	5 mm	1	194913
Holder 1/100	100 mm	5 mm	1	203661
Holder 1/150	150 mm	5 mm	1	197955
Holder 1 / 200	200 mm	5 mm	1	265136

AGR: 07.110

Holder 2 double, sloped

Characteristics

- Double, sloped hook-end

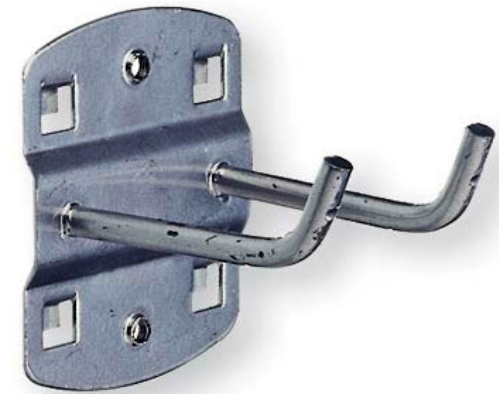

Title	Length	Width	Ø	PU Piece	Article No.
Holder 2 double, sloped	35 mm	35 mm	5 mm	1	195731
Holder 2 double, sloped	50 mm	35 mm	5 mm	1	195251
Holder 2 double, sloped	75 mm	35 mm	5 mm	1	194875
Holder 2 double, sloped	150 mm	35 mm	5 mm	1	265209

AGR: 07.110

15

Holder 3 xs, straight

Characteristics

- Plain, vertical hook-end

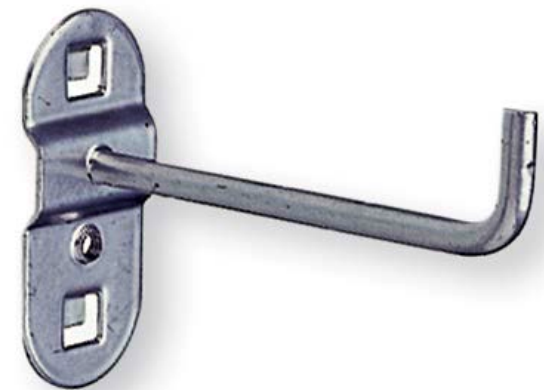

Title	Length	Width	Ø	PU Piece	Article No.
Holder	35 mm	20 mm	5 mm	1	195820
Holder	75 mm	20 mm	5 mm	1	265152
Holder	125 mm	20 mm	5 mm	1	265160

AGR: 07.110

INTERNAL/Approved (2019-03-22 23:49:06)

Holder 4 Clips



15

Title	Ø	PU Piece	Article No.
Holder	10 mm	1	194867
Holder	13 mm	1	195235
Holder	16 mm	1	265241
Holder	19 mm	1	197041
Holder	6 mm	1	197033

AGR: 07.110

Holder 5 Cable/Hoses

Application Area

- For hoses and cables



Title	Width	PU Piece	Article No.
Holder 5/160	170 mm	1	195723
AGR: 07.110			

Holder 6 Machines/Pipes

Application Area

- For machines and pipes



15

Title	Width	PU Piece	Article No.
Holder 6/100	60 mm	1	265101
AGR: 07.110			
Accessories Available		PU Amount	Article No.
Holder 6/60 for machines and pipes		1	198960

Peg-board systems

Holder 7 Pliers

Application Area

- For pliers



Title	Length	Width	Ø	PU Piece	Article No.
Holder 7/35	35 mm	20 mm	5 mm	1	195200
Holder 7/55	55 mm	20 mm	5 mm	1	195197
Holder 7/75	75 mm	20 mm	5 mm	1	265349

AGR: 07.110

15

Holder 8 single, sloped

Characteristics

- Sloping hook



Title	Length	Width	Ø	PU Piece	Article No.
Holder 8/40	40 mm	14 mm	5 mm	1	195740

AGR: 07.110

Holder 9 Machines

Application Area

- For machines



Title	Ø	PU Piece	Article No.
Holder 9/40	40 mm	1	195189
Holder 9/60	60 mm	1	195170
Holder 9/80	80 mm	1	265489

AGR: 07.110

Holder 10 Wrenches

Application Area

- For wrenches

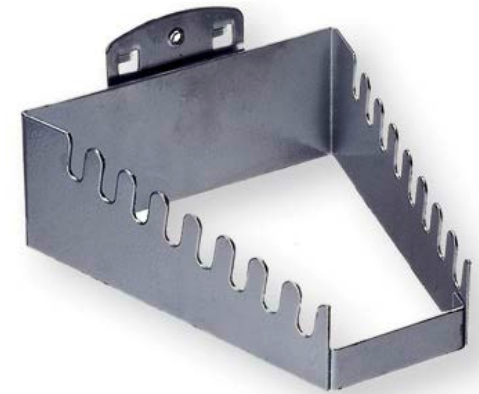

Title	Length	Width	Adapter	PU Piece	Article No.
Holder 10/8	140 mm	130 mm	8 -fold	1	194891

AGR: 07.110

INTERNAL/Approved (2019-03-22 23:49:44)

Peg-board systems

Holder 11 Screwdrivers

Application Area

- For screwdrivers



Title	Length	Width	Adapter	PU Piece	Article No.
Holder 11/6	200 mm	30 mm	6 -fold	1	194905
Holder 11/12	390 mm	30 mm	12 -fold	1	266027

AGR: 07.110

Holder 12 Driller

Application Area

- For drillers



Title	Length	Width	Adapter	Plug-in Ø	PU Piece	Article No.
Holder 12/14	200 mm	25 mm	14 -fold	2 mm - 16 mm	1	195766
Holder 12/28	390 mm	25 mm	28 -fold	2 mm - 16 mm	1	266213

AGR: 07.110

Holder 13 Rack

Application Area

- For depositing racks



Title	Length	Width	PU Piece	Article No.
Holder 13	350 mm	125 mm	1	195758

AGR: 07.110

Holder-Assortment, 10 Part

Application Area

- For cutting discs and grinding wheels

Characteristics

- Suitable for heavy loads



Title	PU Piece	Article No.
Holder-Assortment, 10 Parts	1	343013
AGR: 07.110		
Scope Of Supply	Piece	Article No.
Holder 1/100 with hooks	2	203661
Holder 1 / 200 with hooks	6	265136
Holder 1/50 with hooks	2	194913

Holder-Assortment 49 Part

Hints

- Hooks and holders provide an ideal order system in connection with perforated panels
- Assortment contains the most common hooks and holders in quantities

Title	PU Piece	Article No.
Holder Assortment 49 Parts	1	195600
AGR: 07.110		
Scope Of Supply	Piece	Article No.
Holder 1/100 with hooks	3	203661
Holder 1/150 with hooks	2	197955
Holder 11/6 for screwdrivers	1	194905
Holder 1 / 200 with hooks	2	265136
Holder 12/14 for drills	1	195766
Holder 1/50 with hooks	5	194913
Holder 2 double, sloped, HL 2/75	1	195731
Holder 2 double, sloped, HL 2/50	1	195251

Peg-board systems

Scope Of Supply	Piece	Article No.
Holder 2 double, sloped HL 2/35	1	194875
Holder HL 3/125 with hooks	2	265160
Holder HL 3/35 with hooks	3	195820
Holder HL 3/75 with hooks	3	265152
Holder HL 4/10	3	194867
Holder HL 4/13 with clamp	3	195235
Holder HL 4/16 with clamps	2	265241
Holder HL 4/19 with clamps	2	197041
Holder HL 4/6 with clamps	3	197033
Holder 6/100 for machines and pipes	1	265101
Holder 6/60 for machines and pipes	1	198960
Holder 7/35 for nippers	1	195200
Holder 7/55 for nippers	1	195197
Holder HL 7/75 for nippers	1	265349
Holder 8/40	2	195740
Holder 9/40 for machines	1	195189
Holder 9/60 for machines	1	195170
Holder HL 9/80 for machines	2	265489

Workshop trolley "Revolution", extension parts

Application Area

- For machines and pipes

Characteristics

- Suitable as tray or writing board, has the ability to swivel

Hints

- Includes mounting material and adapter for attachment to the Evolution workshop cart



Peg-board systems



15

Title	External Width	Height, External	Depth, Exterior	PU Piece	Article No.
Windscreen holder set (4-part)	-	-	-	1	037570*
Holder 6/60	100 mm	750 mm	60 mm	1	198960
Multiplex wooden worktop	225 mm	405 mm	25 mm	1	037549
Multiplex Large Wooden Worktop	305 mm	405 mm	25 mm	1	051247
Table	450 mm	288 mm	250 mm	1	051249*
Empty tool/system box wall	808 mm	-	494 mm	1	037571

* = The delivery time is 30 days

AGR: 07.110 / 08.100

INTERNAL/Approved (2019-03-22 23:50:27)

BERA® System Boxes

- Breakproof
- Content can be seen without opening the box
- Transparent cover with label tray, lockable in 2 positions
- Easy removal
- Can be firmly connected to stacks or rows
- Universal use: Single, on wall rails or shelves



Application Area

- Dust-free storage of small parts

Characteristics

- Polypropylene (PP) boxes provide a good chemical stability against many acids, solutions, alcohol and the most engine oils. Damage may occur when in contact with fuel. Fold cover polystyrene (PS), here damage may occur when in contact with acids, engine oils and fuel.

15

Title	Height, External	Depth, Exterior	External Width	PU Piece	Article No.
Bera Box size 4	101 mm	180 mm	96 mm	1	303178
Bera-Box size 5	101 mm	113 mm	96 mm	1	324353
Bera-Box size. 3	127 mm	229 mm	143 mm	1	303186

AGR: 07.011

Accessories Available

	PU Piece	Article No.
BS 1909 INSERTER NEUTRAL	1	303810
Bera Hanging Rail BS 1300	1	310425
Shelf N 15 ED empty	1	232920

BERA® Hanging Rail BS 1300

- For 6 storage boxes in size 3 or 9 storage boxes in size 4 or 5
- Optional 6 Midi or Mini Bera boxes

Application Area

- For the wall mounting for the attachment of storage or system boxes

Hints

- Delivery without boxes

Technical Data

Material Steel

Title	Width	Depth	Color	PU Piece	Article No.
Bera Hanging Rail BS 1300	870 mm	100 mm	Anthracite	1	310425

AGR: 07.000

Storage Boxes

- shock resistant
- Stackable
- Temperature resistant up to +70 °C
- With label compartment

Application Area

- Storage of small parts

Characteristics

- Sizes 1 and 2 made of polystyrene (PS) provide very good chemical resistance against many solutions and alcohol. Damage may occur in contact with acids, motor oils and fuel.
- Sizes 3 - 5 made of polypropylene (PP), offers very good chemical resistance to many acids, alkalis, alcohol and most motor oils. Damage may occur in contact with gasoline

Hints

- Suitable for labels of different sizes 1 – 3 (28 x 84 mm) prod.-no. 965158
- Suitable for labels of different sizes 4, 5 (16 x 60 mm) prod.-no. 965159

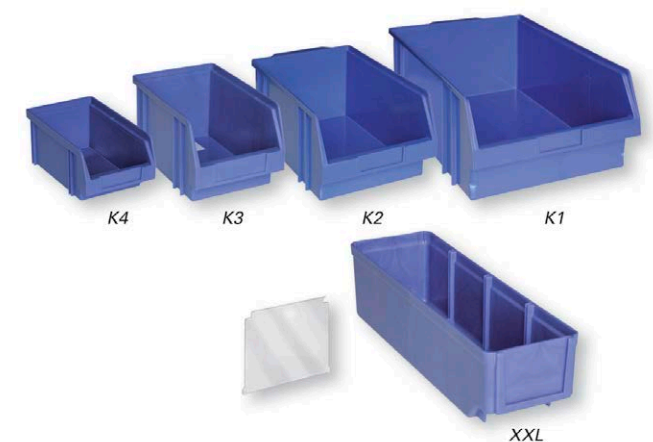

Storage boxes

Title	Size	Color	External Width	Height, External	Depth, Exterior	PU Piece	Article No.
Storage Box	Size 1	Blue	306 mm	183 mm	473 mm	1	020005
Storage Box	Size 1	Green	306 mm	183 mm	473 mm	1	020012
Storage Box	Size 1	Red	306 mm	183 mm	473 mm	1	020010
Storage Box	Size 1	Yellow	306 mm	183 mm	473 mm	1	020009
Storage Box	Size 2	Blue	210 mm	153 mm	348 mm	1	020013
Storage Box	Size 2	Green	210 mm	153 mm	348 mm	1	020025
Storage Box	Size 2	Red	210 mm	153 mm	348 mm	1	020024
Storage Box	Size 2	Yellow	210 mm	153 mm	348 mm	1	020022
Storage Box	Size 3	Blue	143 mm	125 mm	223 mm	1	020026
Storage Box	Size 3	Green	143 mm	125 mm	223 mm	1	020030
Storage Box	Size 3	Red	143 mm	125 mm	223 mm	1	020028
Storage Box	Size 3	Yellow	143 mm	125 mm	223 mm	1	020027
Storage Box	Size 4	Blue	98.5 mm	73 mm	165 mm	1	020033
Storage Box	Size 4	Green	98.5 mm	73 mm	165 mm	1	020038
Storage Box	Size 4	Red	98.5 mm	73 mm	165 mm	1	020037
Storage Box	Size 4	Yellow	98.5 mm	73 mm	165 mm	1	020036
Storage Box	Size 5	Blue	98.5 mm	60 mm	95 mm	1	020039
Storage Box	Size 5	Green	98.5 mm	50 mm	95 mm	1	020043
Storage Box	Size 5	Red	98.5 mm	60 mm	95 mm	1	020042
Storage Box	Size 5	Yellow	98.5 mm	50 mm	95 mm	1	020040

AGR: 07.010

Accessories Available

	PU Piece	Article No.
INSERTER F. BOX 1-3]24PCS[1	158667

Spare Parts

	PU Piece	Article No.
Bera Hanging Rail BS 1300	1	310425
Shelf N 15 ED empty	1	232920

Assortment Metal Box (Empty)

- Box for assortment inserts.
- Comfortable plastic handle.
- Secure turn closing.
- Material: metal.
- Dimensions (H x W x D): 60 x 330 x 230 mm.

Characteristics

- Sendzimir-galvanized (15 – 20 µm)

Hints

- Also available fully stocked (see BS-product ranges)
- One plastic insert per base box

15

Title	Height, External	External Width	Depth, Exterior	PU Piece	Article No.
BS Basic Box	60 mm	330 mm	230 mm	1	167665

AGR: 07.920

BS assortments

Assortment Safe and Strongbox (Empty)

- Mounting on shelves or workshop wall possible
- Lockable and stackable
- Possible to open the assortments in the safe
- Robust steel sheet design

Application Area

- For loading with BS base boxes or BS assortments

Characteristics

- Sendzimir-galvanized (15 – 20 µm)

Hints

- The sortiment safe is supplied empty, without the basic boxes



Accessories for "Evolution" Rolling Workbench

Characteristics

- Bera assortments can be housed in pairs in the drawers

Hints

- One inlet fits in one BS-basic box
- Two inlets fit in one Bera module shelf drawer



Title	Subjects, Number	Height, External	External Width	Depth, Exterior	PU Piece	Article No.
SPACER EMPTY 340X65X30	-	51 mm	325 mm	70 mm	1	041508
Plastic inlets	4 PC	50 mm	325 mm	225 mm	1	007148
Square plastic	6 PC	50 mm	325 mm	225 mm	1	317241
Plastic inlets	6 PC	50 mm	325 mm	225 mm	1	278904
Plastic inlets	8 PC	50 mm	325 mm	225 mm	1	024198
BERA plastic insert tray 10 cavities	10 PC	50 mm	325 mm	225 mm	1	912181
Plastic inlets	12 PC	50 mm	325 mm	225 mm	1	234800
Plastic inlets	14 PC	50 mm	325 mm	225 mm	1	232815
Plastic inlets	18 PC	50 mm	325 mm	225 mm	1	232807
Plastic inlets	20 PC	50 mm	325 mm	225 mm	1	232823

AGR: 07.955 / 08.104

BS assortments**Berner Assortment Empty 18-compartment**

- Material: steel sheet blue varnished
- With plastic insert



BS assortments



Title	Subjects, Number	Height, External	External Width	Depth, Exterior	PU Piece	Article No.
BS 3089 SH MET BOX EMPTY 8-F.	8 PC	60 mm	330 mm	230 mm	1	806037
BS 3484 SH MET BOX EMPTY 10-F	10 PC	60 mm	330 mm	230 mm	1	248800
BS 3081 EMPTY 12-COMPT.	12 PC	60 mm	330 mm	230 mm	1	234818
BS 3088 EMPTY 13/1-COMPT.	14 PC	60 mm	330 mm	230 mm	1	233994
BS 3082 EMPTY 18-COMPT.	18 PC	60 mm	330 mm	230 mm	1	233978
BS 3086 EMPTY 20-COMPT.	20 PC	60 mm	330 mm	230 mm	1	233986

AGR: 07.920

BS 3002 Sheet Metal Screws, Phillips Head

Characteristics

- DIN 7981, ISO 7049 with raised pan head
- DIN 7983, ISO 7051 with countersunk head
- Stainless steel

Hints

- Also available as a refill assortment without case

Scope Of Delivery

- 18 Dimensions
- 1 plastic insert
- 1 BS-assortment case
- 1,800 parts



Title	PU Assortment	Article No.
BS 3002 Sheet Metal Screws, Slotted	1	232505

AGR: 07.900

Scope Of Supply	Piece	Article No.
Cross recessed pan head tapping screw DIN7981 3,5x9,5 zinc-plated	100	087769
Recessed Raised Countersunk Tappingscrew DIN7983 3,5x13 zinc-plated	100	089036
Recessed Raised Countersunk Tappingscrew DIN7983 3,5x16 zinc-plated	100	089044
Cross recessed pan head tapping screw DIN7981 3,5x16 zinc-plated	100	087785
Recessed Raised Countersunk Tappingscrew DIN7983 3,5x19 zinc-plated	100	089052
Cross recessed pan head tapping screw DIN7981 3,5x19 zinc-plated	100	087793
Cross recessed pan head tapping screw DIN7981 4,2x9,5 zinc-plated	100	087920
Recessed Raised Countersunk Tappingscrew DIN7983 4,2x13 zinc-plated	100	089192
Cross recessed pan head tapping screw DIN7981 4,2x16 zinc-plated	100	087947
Recessed Raised Countersunk Tappingscrew DIN7983 4,2x16 zinc-plated	100	089206
Cross recessed pan head tapping screw DIN7981 4,2x19 zinc-plated	100	087955
Recessed Raised Countersunk Tappingscrew DIN7983 4,2x22 zinc-plated	100	089222
Cross recessed pan head tapping screw DIN7981 4,8x13 zinc-plated	100	088021

Scope Of Supply	Piece	Article No.
Recessed Raised Countersunk Tappingscrew DIN7983 4,8x13 zinc-plated	100	089281
Cross recessed pan head tapping screw DIN7981 4,8x19 zinc-plated	100	088048
Recessed Raised Countersunk Tappingscrew DIN7983 4,8x19 zinc-plated	100	089303
Recessed Raised Countersunk Tappingscrew DIN7983 4,8x22 zinc-plated	100	089311
Cross recessed pan head tapping screw DIN7981 4,8x22 zinc-plated	100	088056
Accessories Available	PU Amount	Article No.
BS 3006 TOP UP RANGE	1	091413

BS 3007 BS 3007 Slotted Sheet Metal Screws and Self-Tapping Screws

Characteristics

- DIN 7981, ISO 7049 with raised pan head
- DIN 7983, ISO 7051 with countersunk head
- Steel, black zinc plated

Hints

- Also available as a refill without case

Scope Of Delivery

- 18 Dimensions
- 1 plastic insert
- 1 BS-assortment case
- 1,600 parts



Title	PU Assortment	Article No.
BS 3007 Sheet Metal Screws, Black Slotted	1	232513

AGR: 07.900

Scope Of Supply	Piece	Article No.
Cross recessed pan head tapping screw DIN7981 3,5x13 black zinc-plated	100	091189
Cross recessed pan head tapping screw DIN7981 3,5x19 black zinc-plated	100	091197
Cross recessed pan head tapping screw DIN7981 4,2x16 black zinc-plated	100	091200
Cross recessed pan head tapping screw DIN7981 4,2x19 black zinc-plated	100	091219
Raised Countersunk Tapping screw DIN7983 4,2x19 black zinc-plated	100	091251
Raised Countersunk Tapping screw DIN7983 4,2x25 black zinc-plated	100	091260

INTERNAL/Approved (2019-03-22 23:52:40)

BS assortments

Scope Of Supply	Piece	Article No.
Cross recessed pan head tapping screw DIN7981 4,2x32 black zinc-plated	100	091227
Cross recessed pan head tapping screw DIN7981 4,8x13 black zinc-plated	100	206245
Raised Countersunk Tapping screw DIN7983 4,8x16 black zinc-plated	100	091286
Cross recessed pan head tapping screw DIN7981 4,8x19 black zinc-plated	100	206261
Cross recessed pan head tapping screw DIN7981 4,8x22 black zinc-plated	100	206512
Rosettes 4,8x12,7 black zinc-plated steel	100	020230
ROSETTES 6125 ANTHRACITE	100	807287
Raised Countersunk Tapping screw DIN7983 3,9x9,5 black zinc-plated	100	091243
Raised Countersunk Tapping screw DIN7983 4,8x19 black zinc-plated	100	206296

BS 3008 Sheet Metal Screws with Pressed Washer, Black

Characteristics

- DIN 968 Phillips Pan Head and disk,
- black zinc plated

Hints

- Also available as a refill assortment without case

Scope Of Delivery

- 18 Dimensions
- 1 plastic insert
- 1 BS-assortment case
- 1,400 parts



Title	PU Assortment	Article No.
BS 3008 SHEET CUT PRESS.SCREW	1	173630

AGR: 07.900

Scope Of Supply	Piece	Article No.
Self-tapping screw with collar DIN968 3,5x13 black zinc-plated	100	173371
Self-tapping screw with collar DIN968 3,5x16 black zinc-plated	100	173380
Self-tapping screw with collar DIN968 3,5x19 black zinc-plated	100	173398
Self-tapping screw with collar DIN968 3,5x22 black zinc-plated	100	173401
Self-tapping screw with collar DIN968 3,9x9,5 black zinc-plated	100	173410
Self-tapping screw with collar DIN968 3,9x13 black zinc-plated	100	173428

Scope Of Supply	Piece	Article No.
Self-tapping screw with collar DIN968 3,9x16 black zinc-plated	100	173444
Self-tapping screw with collar DIN968 3,9x19 black zinc-plated	100	173452
Self-tapping screw with collar DIN968 3,9x22 black zinc-plated	100	173479
Self-tapping screw with collar DIN968 4,2x9,5 black zinc-plated	100	173495
Self-tapping screw with collar DIN968 4,2x13 black zinc-plated	100	173517
Self-tapping screw with collar DIN968 4,2x16 black zinc-plated	100	173525
Self-tapping screw with collar DIN968 4,2x19 black zinc-plated	100	173533
Self-tapping screw with collar DIN968 4,2x22 black zinc-plated	100	173541
Self-tapping screw with collar DIN968 4,8x13 black zinc-plated	100	173550
Self-tapping screw with collar DIN968 4,8x16 black zinc-plated	100	173576
Self-tapping screw with collar DIN968 4,8x19 black zinc-plated	100	173614
Self-tapping screw with collar DIN968 4,8x22 black zinc-plated	100	173622

Accessories Available	PU Amount	Article No.
KE 3008 SHEET CUT PRESS.SCREW	1	040551

BS assortments

BS 3013 Hexagon Head Bolts ZI

Characteristics

- Hexagon head bolts DIN 933 (ISO 4017)
- Steel 8.8, zinc plated

Scope Of Delivery

- 12 Dimensions
- 1 plastic insert
- 1 BS-assortment case
- 690 parts



Title	PU Assortment	Article No.
BS 3013 Hexagon Head Bolts ZI	1	318345

AGR: 07.900

Scope Of Supply	Piece	Article No.
Hexagonal Screw DIN933 8.8 M5X20 zinc-plated	100	097250
Hexagonal Screw DIN933 8.8 M6X12 zinc-plated	100	097454
Hexagonal Screw DIN933 8.8 M6X16 zinc-plated	100	097470
Hexagonal Screw DIN933 8.8 M6X20 zinc-plated	100	097330
Hexagonal Screw DIN933 8.8 M6X25 zinc-plated	50	097349
Hexagonal Screw DIN933 8.8 M8X16 zinc-plated	50	097560
Hexagonal Screw DIN933 8.8 M8X20 zinc-plated	50	097608
Hexagonal Screw DIN933 8.8 M8X25 zinc-plated	50	097489
Hexagonal Screw DIN933 8.8 M8X30 zinc-plated	25	097497
Hexagonal Screw DIN933 8.8 M10X20 zinc-plated	25	097691
Hexagonal Screw DIN933 8.8 M10X25 zinc-plated	25	097713
Hexagonal Screw DIN933 8.8 M10X30 zinc-plated	25	097632

Accessories Available	PU Amount	Article No.
KE 3013 STEEL CLIP.DIN 933 ZP	1	040550

BS 3018 Locknuts

Characteristics

- Exhaust-locking nuts DIN 14441, Steel 8, heavily copper
- Lock Nuts DIN 985 (ISO 10511 ~), Steel 8 galvanized

Hints

- Also available as a refill assortment without case

Scope Of Delivery

- 10 Dimensions
- 1 plastic insert
- 1 BS-assortment case
- 700 parts



Title	PU Assortment	Article No.
BS 3018 Locking Nuts	1	280240

AGR: 07.902

Scope Of Supply	Piece	Article No.
Exhaust LockNuts SW12 M8 coppered	100	002500
Exhaust LockNuts SW14 M10 coppered	50	002518
Safety Nuts DIN985 steel 8 M4 zinc-plated	100	006424
Safety Nuts DIN985 steel 8 M5 zinc-plated	100	006432
Safety Nuts DIN985 steel 8 M6 zinc-plated	100	006440
Safety Nuts DIN985 steel 8 M8 zinc-plated	100	006467
Safety Nuts DIN985 steel 8 M10 zinc-plated	50	006475
Safety Nuts DIN985 steel 8 M10X1,00 zinc-plated	50	006289
Safety Nuts DIN985 steel 8 M12 zinc-plated	25	006483
Safety Nuts DIN985 steel 8 M12X1,50 zinc-plated	25	006297

Accessories Available	PU Amount	Article No.
KE 3018 FUSE LOCK.NUTS	1	040556

INTERNAL/Approved (2019-03-22 23:54:36)

BS 3019 Nuts, Flat Washers and Spring Lock Washers ZI

Characteristics

- Hexagonal nuts DIN 934, ISO 4032, steel 8
- Flat washers DIN 125, ISO 7089 standard range (type A)
- Spring lock washers DIN 127 (type B)
- Zinc plated steel

Hints

- Also available as a refill assortment without case

Scope Of Delivery

- 12 dimensions
- 1 plastic insert
- 1 BS-assortment case
- 2,400 parts



15

Title	PU Assortment	Article No.
BS 3019 LOCK.ELEMENTS	1	280160

AGR: 07.902

Scope Of Supply	Piece	Article No.
Hexagon Nuts DIN934 steel 8 M4 zinc-plated	250	004332
Hexagon Nuts DIN934 steel 8 M5 zinc-plated	250	004340
Hexagon Nuts DIN934 steel 8 M6 zinc-plated	200	004359
Hexagon Nuts DIN934 steel 8 M8 zinc-plated	100	004375
Flat Washers DIN125-1 A M4 zinc-plated	250	007420
Flat Washers DIN125-1 A M5 zinc-plated	250	007439
Flat Washers DIN125-1 A M6 zinc-plated	200	007447
Flat Washers DIN125-1 A M8 zinc-plated	100	007463
Spring Ring DIN127B M4 zinc-plated	250	003620
Spring Ring DIN127B M5 zinc-plated	250	003638
Spring Ring DIN127B M6 zinc-plated	200	003646
Spring Ring DIN127B M8 zinc-plated	100	003662

Accessories Available	PU Amount	Article No.
KE 3019 LOCK.ELEMENTS	1	040553

BS 3124 Hexagon Socket Head Screws ZI

Characteristics

- Hexagon socket head screw DIN 912 (ISO 4762)
- Steel 8.8, zinc plated

Hints

- Also available as a refill assortment without case (prod. no. 169385)

Scope Of Delivery

- 18 Dimensions
- 1 plastic insert
- 1 BS-assortment case
- 985 parts



Title	PU Assortment	Article No.
BS 3124 Hexagon Socket Head Screws ZI	1	341835

AGR: 07.900

Scope Of Supply	Piece	Article No.
Hexagon Socket Head Cap Screw DIN912 8.8 M4X10 zinc-plated	100	099988
Hexagon Socket Head Cap Screw DIN912 8.8 M5X10 zinc-plated	100	100129
Hexagon Socket Head Cap Screw DIN912 8.8 M5X16 zinc-plated	100	100145
Hexagon Socket Head Cap Screw DIN912 8.8 M5X20 zinc-plated	100	100161
Hexagon Socket Head Cap Screw DIN912 8.8 M5X30 zinc-plated	50	100196
Hexagon Socket Head Cap Screw DIN912 8.8 M6X16 zinc-plated	50	100315
Hexagon Socket Head Cap Screw DIN912 8.8 M6X20 zinc-plated	50	100331
Hexagon Socket Head Cap Screw DIN912 8.8 M6X30 zinc-plated	30	100366
Hexagon Socket Head Cap Screw DIN912 8.8 M6X35 zinc-plated	30	100374
Hexagon Socket Head Cap Screw DIN912 8.8 M8X16 zinc-plated	25	100536
Hexagon Socket Head Cap Screw DIN912 8.8 M8X20 zinc-plated	25	100552
Hexagon Socket Head Cap Screw DIN912 8.8 M8X25 zinc-plated	25	100579
Hexagon Socket Head Cap Screw DIN912 8.8 M8X30 zinc-plated	25	100587
Hexagon Socket Head Cap Screw DIN912 8.8 M8X40 zinc-plated	15	100609
Hexagon Socket Head Cap Screw DIN912 8.8 M10X30 zinc-plated	10	100803
Hexagon Socket Head Cap Screw DIN912 8.8 M10X20 zinc-plated	15	100773
Hexagon Socket Head Cap Screw DIN912 8.8 M5X8 zinc-plated	100	100110

INTERNAL/Approved (2019-03-22 23:55:08)

BS 3021 Copper Sealing Rings

Characteristics

- DIN 7603, copper, solid, flat gasket, type A,
- heat resistant up to approx. 900 ° C

Hints

- Also available as a refill assortment without case (prod. no. 117 530)

Scope Of Delivery

- 18 sizes
- 1310 parts



Title	PU Assortment	Article No.
BS 3021 Copper Sealing Rings	1	235253

AGR: 07.902

Scope Of Supply	Piece	Article No.
Sealing Rings DIN7603 M6x10x1 copper	100	000558
Sealing Rings DIN7603 M6x12x1 copper	100	000566
Sealing Rings DIN7603 M8x12x1 copper	100	000574
Sealing Rings DIN7603 M8x14x1 copper	100	000582
Sealing Rings DIN7603 M10x14x1 copper	100	000809
Sealing Rings DIN7603 M10x16x1 copper	100	000817
Sealing Rings DIN7603 M12x16x1,5 copper	100	000604
Copper sealing ring 12x18x1.5	100	000833
Sealing Rings DIN7603 M14x18x1,5 copper	100	000612
Copper sealing ring 14x20x1.5	100	000620
Sealing Rings DIN7603 M 16x20x1,5 copper	50	000647
Sealing Rings DIN7603 M16x22x1,5 copper	50	000825
Sealing Rings DIN7603 M18x24x1,5 copper	50	000671
Sealing Rings DIN7603 M 20x26x1,5 copper	50	000698
Sealing Rings DIN7603 M 22x27x1,5 copper	50	000701
Copper sealing ring 26x32x2	25	000744
Sealing Rings DIN7603 M 30x36x2 copper	25	000787
Sealing Rings DIN7603 M32x38x2 copper	10	000795

Accessories Available	PU Amount	Article No.
KE 3021 SEAL RINGS 7603 CU	1	040573

Assortment Box BS 3022 Aluminum Sealing Rings

Characteristics

- DIN 7603, aluminum, flat gasket, type A,
- heat resistant up to 300 ° C

Hints

- Also available as a refill assortment without case (prod. no. 117529)

Scope Of Delivery

- 17 dimensions
- 1300 parts



Title	PU Assortment	Article No.
Aluminium Sealing Ring DIN 7603	1	235261

AGR: 07.902

Scope Of Supply	Piece	Article No.
Sealing Rings DIN7603 M5x9x1 Aluminium	100	001180
Sealing Rings DIN7603 M6x10x1 Aluminium	100	001198
Sealing Rings DIN7603 M6x12x1 Aluminium	100	001201
Sealing Rings DIN7603 M8x12x1 Aluminium	100	001210
Sealing Rings DIN7603 M8x14x1 Aluminium	100	001228
Sealing Rings DIN7603 M10x14x1 Aluminium	100	001236
Aluminium sealing ring 12x18x1.5	100	001252
Sealing Rings DIN7603 M14x18x1,5 Aluminium	100	001260
Aluminium sealing ring 14x20x1.5	100	001279
Sealing Rings DIN7603 M16x22x1,5 Aluminium	50	001287
Alu-Sealing Rings DIN 7603 Form A 18x24x1,5	50	001309
Sealing Rings DIN7603 M20x26x1,5 Aluminium	50	001325

INTERNAL/Approved (2019-03-22 23:55:58)

BS assortments

Scope Of Supply	Piece	Article No.
Sealing Rings DIN7603 M22x27x1,5 Aluminium	50	001333
Sealing Rings DIN7603 M22x29x1,5 Aluminium	50	001341
Sealing Rings DIN7603 M24x30x2 Aluminium	25	001350
Sealing Rings DIN7603 M26x32x2 Aluminium	25	001376
Sealing Rings DIN7603 M10x16x1,0 Aluminium	100	800394
Accessories Available	PU Amount	Article No.
KE 3022 SEAL RINGS 7603 ALU	1	040572

BS 3024 Seals for Oil Drain Plugs

Scope Of Delivery

- 11 dimensions
- 625 pieces

Title	PU Assortment	Article No.
BS 3024 DRAIN PL SEALING RING	1	235288

AGR: 07.900

Scope Of Supply	Piece	Article No.
Aluminium sealing ring 12x18x1.5	50	001252
Rubber sealing ring 13x22x3	50	165182
Sealing Rings DIN7603 M 20x26x1,5 copper	25	000698
Sealing Rings DIN7603 M12x18x2 copper	50	413933
Sealing Rings DIN7603 M22x27x1,5 Aluminium	50	001333
PA sealing ring Ford 13x20x2	50	080705
Sealing Rings DIN7603 M14x20x2 copper	100	413950
Sealing Ring DIN 7603 Form C 18x24x2	100	414000
Polyamid sealing ring 14x22x2.5	50	080632
Copper sealing ring (filling ring) 16x22x2	50	413976
Rubber sealing ring 18x22x2	50	165181



BS 3025 Seals, Copper-Filling Rings - Free of Asbestos

Characteristics

- DIN 7603, copper, asbestos-free, form C,
- heat-resistant up to 1100 °C

Scope Of Delivery

- 15 dimensions
- 1025 parts



Title	PU Assortment	Article No.
BS 3025 SEALG RNG CU-FILLG RI.	1	260908

AGR: 07.902

Scope Of Supply	Piece	Article No.
Sealing Rings DIN7603 M6x12x1,5 copper	100	413879
Sealing Rings DIN7603 M8x12x1,5 copper	100	413887
Sealing Rings DIN7603 M8x14x1,5 copper	100	413895
Sealing Rings DIN7603 M10x16x1,5 copper	100	413917
Sealing Rings DIN7603 M12x16x2 copper	100	413925
Sealing Rings DIN7603 M12x18x2 copper	100	413933
Sealing Rings DIN7603 M14x18x2 copper	100	413941
Sealing Rings DIN7603 M14x20x2 copper	50	413950
Sealing Rings DIN7603 M16x20x2 copper	50	413968
Copper sealing ring (filling ring) 16x22x2	50	413976
Sealing Ring DIN 7603 Form C 18x24x2	50	414000
Filling Seal DIN7603 M20x26x2 copper	50	-
Filling Seal DIN7603 M22x27x2 copper	25	-
Filling Seal DIN7603 M24x32x2,5 copper	25	-
Filling Seal DIN7603 M26x32x2,5 copper	25	-
(99774_11_50_AT01_KupferFillringeDIN760320)	50	-
(99774_12_25_AT01_KupferFillringeDIN760326)	25	-

INTERNAL/Approved (2019-03-22 23:56:54)

BS assortments

BS 3027 Steel / Rubber Sealing Rings (Bonded Seal)

Characteristics

- Temperature resistant from -30 ° C to +120 ° C, resistant to mineral oils, petrol, gas and water, pressure resistant up to max. 300 bar
- Carrier: steel, galvanized, yellow
- Rubber: NBR elastomer

Hints

- Also available as a refill assortment without case

Scope Of Delivery

- 10 Dimensions
- 1 plastic insert
- 1 BS-assortment case
- 130 parts



15

Title	PU Piece	Article No.
BS 3027 steel / rubber sealing rings	1	134797

AGR: 07.902

Scope Of Supply	Piece	Article No.
Steel/Rubber Gasket 6,7x11x1 mm	10	765147
Steel/Rubber Gasket 8,7x13x1 mm	10	778150
Steel/Rubber Gasket 10,7x16x1,5 mm	10	778168
Steel/Rubber Gasket 12,7x18x1,5 mm	10	106400
Steel/Rubber Gasket 14,7x21x1,5 mm	25	106401
Steel/Rubber Gasket 16,7x24x1,5 mm	25	936773
Steel/Rubber Gasket 18,7x26x1,5 mm	10	106404
Steel/Rubber Gasket 20,7x28x1,5 mm	10	106405
Steel/Rubber Gasket 22,7x30x2 mm	10	778141
Steel/Rubber Gasket 24,7x32x2 mm	10	778176

BS 3030 External Retaining Rings

Characteristics

- Circlips (retaining rings) DIN 471, standard design
- Spring steel blank (or phosphated and oiled, depending on the brand)

Hints

- Also available as a refill assortment case

Scope Of Delivery

- 18 sizes
- 650 parts



Title	PU Assortment	Article No.
BS 3030 External Retaining Ring	1	235296

AGR: 07.902

Scope Of Supply	Piece	Article No.
Retaining Ring DIN 471 8X0,80 plain	100	006793
Retaining Ring DIN 471 10X1,00 plain	100	006815
Retaining Ring DIN 471 12X1,00 plain	100	006823
Retaining Ring DIN 471 14X1,00 plain	100	006831
Retaining Ring DIN 471 15X1,00 plain	100	006840
Retaining Ring DIN 471 16X1,00 plain	100	006858
Retaining Ring DIN 471 17X1,00 plain	50	006866
Retaining Ring DIN 471 18X1,20 plain	50	006874
Retaining Ring DIN 471 20X1,20 plain	50	006882
Retaining Ring DIN 471 22X1,20 plain	25	006890
Retaining Ring DIN 471 24X1,20 plain	25	006904
Retaining Ring DIN 471 25X1,20 plain	25	006912
Retaining Ring DIN 471 26X1,20 plain	25	006920
Retaining Ring DIN 471 28X1,50 plain	25	006939
Retaining Ring DIN 471 30X1,50 plain	25	006947
Retaining Ring DIN 471 32X1,50 plain	25	006963
Retaining Ring DIN 471 35X1,50 plain	25	006955
Retaining Ring DIN 471 40X1,75 plain	25	006980

INTERNAL/Approved (2019-03-22 23:57:26)

BS assortments

Accessories Available	PU Amount	Article No.
KE 3030 A-FU.RINGS DIN 471	1	040564

BS 3031 Internal Retaining Rings

Characteristics

- Circlips (retaining rings) DIN 472, standard design
- Spring steel blank (or phosphated and oiled, depending on the brand)

Hints

- Also available as a refill assortment case

Scope Of Delivery

- 18 sizes
- 1 plastic insert
- 1 BS-assortment case
- 650 parts



Title	PU Assortment	Article No.
BS 3031 Internal Retaining Ring	1	235300

AGR: 07.902

Scope Of Supply	Piece	Article No.
Retaining Ring DIN472 15X1,00 plain	50	007005
Retaining Ring DIN472 16X1,00 plain	50	007013
Retaining Ring DIN472 18X1,00 plain	50	007021
Retaining Ring DIN472 20X1,00 plain	50	007048
Retaining Ring DIN472 22X1,00 plain	50	007056
Retaining Ring DIN472 23X1,20 plain	50	007064
Retaining Ring DIN472 24X1,20 plain	50	007072
Retaining Ring DIN472 25X1,20 plain	50	007080
Retaining Ring DIN472 26X1,20 plain	25	007099
Retaining Ring DIN472 28X1,20 plain	25	007102
Retaining Ring DIN472 30X1,20 plain	25	007110
Retaining Ring DIN472 32X1,20 plain	25	007129
Retaining Ring DIN472 34X1,50 plain	25	007145

Scope Of Supply	Piece	Article No.
Retaining Ring DIN472 35X1,50 plain	25	007153
Retaining Ring DIN472 36X1,50 plain	25	007161
Retaining Ring DIN472 37X1,50 plain	25	007170
Retaining Ring DIN472 38X1,50 plain	25	007188
Retaining Ring DIN472 40X1,75 plain	25	007196
Accessories Available	PU Amount	Article No.
KE 3031 I-FU.RINGS DIN 472	1	040562

BS assortments

BS 3033 Medium Compensation Washers

Characteristics

- Steel blank

Scope Of Delivery

- 15 Dimensions
- 1 plastic insert
- 1 BS-assortment case
- 375 parts



Title	PU Assortment	Article No.
BS 3033 Medium Compensation Washers	1	235326

AGR: 07.903

Scope Of Supply	Piece	Article No.
Adjustment washer 22x32x0,3 plain	25	007927
Adjustment washer 22x32x0,5 plain	25	008214
Adjustment washer 22x32x1 plain	25	008508
Adjustment washer 25x36x0,3 plain	25	007935
Adjustment washer 25x36x0,5 plain	25	008222
Adjustment washer 25x36x1 plain	25	008516
Adjustment washer 26x37x0,3 plain	25	007897
Adjustment washer 26x37x0,5 plain	25	008184
Adjustment washer 26x37x1 plain	25	008478
Adjustment washer 28x40x0,3 plain	25	007943
Adjustment washer 28x40x0,5 plain	25	008230
Adjustment washer 28x40x1 plain	25	008524
Adjustment washer 30x42x0,3 plain	25	007951
Adjustment washer 30x42x0,5 plain	25	008249
Adjustment washer 30x42x1 plain	25	008532

BS 3034 Compensation Washers, Large

Characteristics

- Steel blank

Scope Of Delivery

- 15 Dimensions
- 1 plastic insert
- 1 BS-assortment case
- 375 parts



Title	PU Assortment	Article No.
BS 3034 Compensation Washers, Large	1	235334

AGR: 07.903

Scope Of Supply	Piece	Article No.
Adjustment washer 32x45x0,3 plain	25	007960
Adjustment washer 32x45x0,5 plain	25	008257
Adjustment washer 32x45x1 plain	25	008540
Adjustment washer 35x45x0,3 plain	25	007978
Adjustment washer 35x45x0,5 plain	25	008265
Adjustment washer 35x45x1 plain	25	008559
Adjustment washer 36x45x0,3 plain	25	007986
Adjustment washer 36x45x0,5 plain	25	008273
Adjustment washer 36x45x1 plain	25	008567
Adjustment washer 40x50x0,3 plain	25	008001
Adjustment washer 40x50x0,5 plain	25	008290
Adjustment washer 40x50x1 plain	25	008583
Adjustment washer 42x52x0,3 plain	25	007846
Adjustment washer 42x52x0,5 plain	25	008117
Adjustment washer 42x52x1 plain	25	008427

INTERNAL/Approved (2019-03-22 23:58:22)

BS assortments

BS 3035 Lock Washers

Characteristics

- Lock washers (retaining washers) DIN 6799
- Spring steel blank (rolled and oiled)

Hints

- Also available as a refill assortment without case

Scope Of Delivery

- 10 Dimensions
- 1 plastic insert
- 1 BS-assortment case
- 850 parts



Title	PU Assortment	Article No.
BS 3035 Lock Washers	1	235342

AGR: 07.902

Scope Of Supply	Piece	Article No.
Sicherungsscheibe DIN6799 2,3 plain	100	003115
Sicherungsscheibe DIN6799 3,2 plain	100	003123
Sicherungsscheibe DIN6799 4,0 plain	100	003131
Sicherungsscheibe DIN6799 5,0 plain	100	003140
Sicherungsscheibe DIN6799 6,0 plain	100	003158
Sicherungsscheibe DIN6799 7,0 plain	100	003166
Sicherungsscheibe DIN6799 8,0 plain	100	003174
Sicherungsscheibe DIN6799 9,0 plain	100	003182
Sicherungsscheibe DIN6799 10,0 plain	100	003190
Sicherungsscheibe DIN6799 12,0 plain	100	003204

BS 3036 Metric O-Rings

Characteristics

- Temperature resistant from -30 ° C to +130 ° C, resistant to petrol, oil, grease, hot water, steam, compressed air and weak acids
- Nitrile (NBR 70)



Hints

- Also called Refill assortment without case available (Item No. 169383)

Scope Of Delivery

- 18 Dimensions
- 1 plastic insert
- 1 BS-range suitcase
- 1.000 parts

Title	PU Assortment	Article No.
BS 3036 Metric O-rings	1	148045

AGR: 07.903

Scope Of Supply	Piece	Article No.
Metric O-Rings M3x2 mm	100	122051
Metric O-Rings M4x2 mm	100	122052
Metric O-Rings M5x2 mm	100	122053
Metric O-Rings M6x2 mm	100	122054
Metric O-Rings M7x2 mm	100	122055
Metric O-Rings M8x2 mm	100	122056
Metric O-Rings M10x2,5 mm	50	122057
Metric O-Rings M12x2,5 mm	50	122058
Metric O-Rings M14x2,5 mm	50	122059
Metric O-Rings M15x2,5 mm	50	122060
Metric O-Rings M17x2,5 mm	50	122061
Metric O-Rings M18x3 mm	50	122063
Metric O-Rings M19x2,5 mm	20	122062
Metric O-Rings M20x3 mm	20	122064
Metric O-Rings M22x3 mm	20	122065
Metric O-Rings M24x3 mm	20	122066
Metric O-Rings M25x3 mm	10	122067
Metric O-Rings M28x3 mm	10	122069

INTERNAL/Approved (2019-03-22 23:58:56)

BS assortments

BS 3037 Imperial O-Rings

Characteristics

- Temperature resistant from -30 ° C to +130 ° C, resistant to petrol, oil, grease, hot water, steam, compressed air and weak acids
- Nitrile (NBR 70)

Hints

- Also available as a refill assortment without case (prod. no. 117521)

Scope Of Delivery

- 24 Dimensions
- 1 plastic insert
- 1 BS-range suitcase
- 566 parts



Title	PU Assortment	Article No.
BS 3037 Imperial O-Rings	1	235350

AGR: 07.902

Scope Of Supply	Piece	Article No.
Metric O-Rings inch 3,69x1,78 mm	50	001767
Metric O-Rings inch 4,47x1,78 mm	50	001775
Metric O-Rings inch 5,28x1,78 mm	50	001783
Metric O-Rings inch 67x1,78 mm	50	001791
Metric O-Rings inch 7,66x1,78 mm	50	001805
Metric O-Rings inch 9,19x2,62 mm	50	001821
Metric O-Rings inch 9,25x1,78 mm	25	001813
Metric O-Rings inch 10,78x2,62 mm	25	001830
Metric O-Rings inch 12,37x2,62 mm	25	001848
Metric O-Rings inch 13,95x2,62 mm	25	001856
Metric O-Rings inch 15,54x2,62 mm	25	001864
Metric O-Rings inch 17,13x2,62 mm	20	001872
Metric O-Rings inch 18,64x3,53 mm	15	001899
Metric O-Rings inch 18,72x2,62 mm	10	001880
Metric O-Rings inch 20,22x3,53 mm	10	001902
Metric O-Rings inch 23,40x3,53 mm	10	001910

Scope Of Supply	Piece	Article No.
Metric O-Rings inch 250x3,53 mm	10	001929
Metric O-Rings inch 26,57x3,53 mm	10	001937
Metric O-Rings inch 28,17x3,53 mm	10	001945
Metric O-Rings inch 31,34x3,53 mm	10	001953
Metric O-Rings inch 34,52x3,53 mm	10	001961
Metric O-Rings inch 36,10x3,53 mm	10	001970
Metric O-Rings inch 37,47x5,34 mm	8	001988
Metric O-Rings inch 40,65x5,34 mm	8	001996
Accessories Available	PU Amount	Article No.
KE 3037 O-RING INCH	1	040560

BS 4011 Diamond Discs

Characteristics

- Steel galvanized

Scope Of Delivery

- 12 dimensions
- 1100 parts

Title	PU Assortment	Article No.
BS 4011 BODY-SCREENS	1	874487

AGR: 07.903

Scope Of Supply

	Piece	Article No.
Auto body washers for M8 8,4X25X1,5 zinc-plated	100	008966
Auto body washers for M5 5,3X15X1,5 zinc-plated	100	008923
Auto body washers for M10 10,5X30X1,5 zinc-plated	50	008869
Body Washer 13x35x1.5 zinc-plated	50	539597
Auto body washers for M4 4,3X15X1,5 zinc-plated	100	008907
Auto body washers for M5 5,3X20X1,5 zinc-plated	100	008818
Auto body washers for M5 5,3X25X1,5 zinc-plated	100	008931
Auto body washers for M6 6,4X15X1,5 zinc-plated	100	008940
Auto body washers for M6 6,4X20X1,5 zinc-plated	100	008826
Auto body washers for M6 6,4X25X1,5 zinc-plated	100	008958
Auto body washers for M8 8,4X20X1,5 zinc-plated	100	008834
Auto body washers for M8 8,4X30X1,5 zinc-plated	100	008850

Accessories Available

	PU Amount	Article No.
KE 4011 BODY-SCREENS	1	040569



BS 3056 Linch Pins

Characteristics

- Linch pin biased
- Spring steel wire galvanized yellow

Scope Of Delivery

- 4 Dimensions
- 1 plastic insert
- 1 BS-assortment case
- 80 parts



Title	PU Assortment	Article No.
BS 3056 Linch Pins	1	145157

AGR: 07.902

Scope Of Supply	Piece	Article No.
Locking Pin 6 mm yellow zinc-plated	25	002313
Locking Pin 8 mm yellow zinc-plated	25	002321
Locking Pin 9,5 mm yellow zinc-plated	20	002330
Locking Pin 11 mm yellow zinc-plated	10	002348

BS assortments

BS 3062 Cotter Pins

Characteristics

- Cotter pins DIN 94 (ISO 1234)
- Galvanized steel

Hints

- Also available as a refill assortment without case

Scope Of Delivery

- 12 sizes
- 1850 parts



Title	PU Assortment	Article No.
BS 3062 Cotter Pins	1	235377

AGR: 07.902

Scope Of Supply	Piece	Article No.
Splint DIN94 1,0X20 steel zinc-plated	250	002003
Splint DIN94 1,6X32 steel zinc-plated	250	002020
Splint DIN94 2,0X32 steel zinc-plated	250	002054
Splint DIN94 2,5X32 steel zinc-plated	250	002070
Splint DIN94 2,5X40 steel zinc-plated	250	002089
Splint DIN94 3,2X32 steel zinc-plated	100	002097
Splint DIN94 3,2X50 steel zinc-plated	100	002119
Splint DIN94 3,5X40 steel zinc-plated	100	002135
Splint DIN94 4,0X40 steel zinc-plated	100	002151
Splint DIN94 5,0X50 steel zinc-plated	50	002186
Splint DIN94 6,3X63 steel zinc-plated	50	002208
Splint DIN94 4,5X50 steel zinc-plated	100	182010

Accessories Available	PU Amount	Article No.
KE 3062 SPLIT PIN DR. DIN 94	1	040554

BS 3063 Spring Dowel Pins

Characteristics

- Spring pins (dowel pin) DIN 1481 (ISO 8752), slotted, heavy-duty design, spring steel.

Hints

- Also available as refill assortment without case

Scope Of Delivery

- 18 Dimensions
- 1 plastic insert
- 1 BS-assortment case
- 670 parts



Title	PU Assortment	Article No.
BS 3063 Spring Dowel Pins DIN 1481	1	235385

AGR: 07.902

Scope Of Supply	Piece	Article No.
Clamping Pin DIN1481 3X30 spring steel plain	50	000051
Clamping Pin DIN1481 3X40 spring steel plain	50	000078
Clamping Pin DIN1481 4X20 spring steel plain	50	000108
Clamping Pin DIN1481 4X30 spring steel plain	50	000132
Clamping Pin DIN1481 4X40 spring steel plain	50	000159
Clamping Pin DIN1481 4X50 spring steel plain	50	000167
Clamping Pin DIN1481 5X30 spring steel plain	50	000213
Clamping Pin DIN1481 5X40 spring steel plain	50	000248
Clamping Pin DIN1481 5X50 spring steel plain	25	000264
Clamping Pin DIN1481 6X30 spring steel plain	50	000310
Clamping Pin DIN1481 6X40 spring steel plain	50	000337
Clamping Pin DIN1481 6X50 spring steel plain	25	000353
Clamping Pin DIN1481 6X60 spring steel plain	25	000361
Clamping Pin DIN1481 8X40 spring steel plain	25	000400
Clamping Pin DIN1481 8X50 spring steel plain	25	000418
Clamping Pin DIN1481 8X60 spring steel plain	25	000434
Clamping Pin DIN1481 10X50 spring steel plain	10	000485
Clamping Pin DIN1481 10X60 spring steel plain	10	000507

INTERNAL/Approved (2019-03-23 00:01:29)

BS assortments

Accessories Available

	PU Amount	Article No.
KE 3063 CLMPG.SLEEVES DIN 1481	1	040567

BS 3069 Conical Grease Nipple

Characteristics

- Grease nipple DIN 71412, Form A, B and C
- galvanized steel

Hints

- Also available as refill assortment without case

Scope Of Delivery

- 12 Dimensions
- 1 plastic insert
- 1 BS-assortment case
- 300 parts



15

Title	PU Assortment	Article No.
BS 3069 Grease Nipple	1	235415

AGR: 07.903

Scope Of Supply

	Piece	Article No.
Grease Nipple H1 6x1 mm	50	013617
Grease Nipple H1 8x1 mm	50	013625
Grease Nipple H1 10x1 mm	50	013633
Grease Nipple H2 6x1 mm	50	013641
Grease Nipple H2 8x1 mm	50	013650
Grease Nipple H2 10x1 mm	25	013668
Grease Nipple H3 6x1 mm	25	013684
Grease Nipple H3 8x1 mm	25	013692
Grease Nipple H3 10x1 mm	25	013706
Grease Nipple H1 1/4 UNF	25	013722
Grease Nipple H1 5/16 UNF	25	013730
Grease Nipple H1 3/8 UNF	25	013749

BS 3092 Compression Springs

Characteristics

- Compression springs DIN 2095
- Spring steel wire 17223 B, zinc plated

Scope Of Delivery

- 12 Dimensions
- 1 plastic insert
- 1 BS-assortment case
- 250 parts



Title	PU Assortment	Article No.
BS 3092 Compression Springs	1	305375

AGR: 07.902

Scope Of Supply	Sachet	Article No.
Pressure Springs DIN2095 0,8x 8x42 mm, 40 pieces	40	304484
Pressure Springs DIN2095 1,0x15x32 mm, 20 pieces	20	304492
Pressure Springs DIN2095 1,0x12x35 mm, 30 pieces	30	304530
Pressure Springs DIN2095 1x10x40 mm, 25 pieces	25	304573
Pressure Springs DIN2095 1x12x60 mm, 20 pieces	20	304549
Pressure Springs DIN2095 1,5x15x28 mm, 20 pieces	20	304506
Pressure Springs DIN2095 1,5x12x35 mm, 20 pieces	20	304590
Pressure Springs DIN2095 1,5x10x45 mm, 25 pieces	25	304581
Pressure Springs DIN2095 1,5x15x45 mm, 15 pieces	15	304565
Pressure Springs DIN2095 1,5x12x55 mm, 15 pieces	15	304557
Pressure Springs DIN2095 1,5x15x55 mm, 10 pieces	10	304514
Pressure Springs DIN2095 1,5x15x65 mm, 10 pieces	10	304522

15

BS 3093 Tension Springs

Characteristics

- Tension springs DIN 2097, with double eyelets
- galvanized spring steel wire, B 17223

Scope Of Delivery

- 20 Dimensions
- 1 plastic insert



BS assortments

- 1 BS-assortment case
- 376 parts

Title	PU Assortment	Article No.
BS 3093 Tension Spring	1	305367

AGR: 07.902

Scope Of Supply	Amount	Article No.
Extension Spring with Double Eyelet DIN2097 0,6x6x25 mm, 50 pieces	50	304379
Extension Spring with Double Eyelet DIN2097 0,6x5x50 mm, 40 pieces	40	304360
Extension Spring with Double Eyelet DIN2097 0,6x7x55 mm, 25 pieces	25	304352
Extension Spring with Double Eyelet DIN2097 1x9x45 mm, 20 pieces	20	304395
Extension Spring with Double Eyelet DIN2097 1x8x55 mm, 18 pieces	18	304344
Extension Spring with Double Eyelet DIN2097 1x11x55 mm, 10 pieces	10	304409
Extension Spring with Double Eyelet DIN2097 1x10x60 mm, 20 pieces	20	304310
Extension Spring with Double Eyelet DIN2097 1x8x70 mm, 18 pieces	18	304336
Extension Spring with Double Eyelet DIN2097 1x11x70 mm, 18 pieces	18	304301
Extension Spring with Double Eyelet DIN2097 1x9x75 mm, 12 pieces	12	304417
Extension Spring with Double Eyelet DIN2097 1x12x85 mm, 8 pieces	8	304441
Extension Spring with Double Eyelet DIN2097 1x7x90 mm, 20 pieces	20	304328
Extension Spring with Double Eyelet DIN2097 1x9x100 mm, 15 pieces	15	304298
Extension Spring with Double Eyelet DIN2097 1x10x105 mm, 10 pieces	10	304450
Extension Spring with Double Eyelet DIN2097 1x11x130 mm, 10 pieces	10	304280
Extension Spring with Double Eyelet DIN2097 1,3x7x25 mm, 40 pieces	40	304387
Extension Spring with Double Eyelet DIN2097 1,3x11x55 mm, 12 pieces	12	304433
Extension Spring with Double Eyelet DIN2097 1,5x12,5x65 mm, 8 pieces	8	304425
Extension Spring with Double Eyelet DIN2097 1,5x12,5x75 mm, 14 pieces	14	304476
Extension Spring with Double Eyelet DIN2097 1,5x12,5x110 mm, 8 pieces	8	304468

Berner Assortment 3065 Pop Rivets

Characteristics

- DIN 7337, truss head, sleeve aluminium alloy AlMg 2.5 (Ø 3.0 mm) or. AlMg 3 (Ø 4.0 – 5.0 mm), mandrel steel galvanized

Scope Of Delivery

- 11 dimensions
- 901 parts

Title	PU Assortment	Article No.
BS 3065 POP RIVET	1	232572
AGR: 07.901		
Scope Of Supply	Piece	Article No.
Blind Rivets, Flat Round Head 3,2x6 Aluminium/Steel	100	800646
Blind Rivets, Flat Round Head 3,2x12 Aluminium/Steel	100	800509
Blind Rivets, Flat Round Head 4x6 Aluminium/Steel	100	010057
Blind Rivets, Flat Round Head 4x8 Aluminium/Steel	100	010073
Hand Rivet Pliers B 150 A	1	916004
Blind Rivets, Flat Round Head 3,2x10 Aluminium/Steel	100	131380
Blind Rivets, Flat Round Head 3,2x8 Aluminium/Steel	100	800622
Blind Rivet, flat round head 3.2x8 copper/steel	50	804958
Blind Rivets, Flat Round Head 4x12 Aluminium/Steel	50	010090
Blind Rivets, Flat Round Head 3,2x4 Aluminium/Steel	100	800639
Blind Rivet, flat round head 3.2x6 copper/steel	100	804941



KE 3421 Hose Clamps Assortment

Scope Of Delivery

- 5 dimensions
- 100 parts

Title	PU Amount	Article No.
BS 3421 HOSE CLIP RANGE	1	244465
KE 3421 HOSE CLAMPS SORT.	1	040615
AGR: 07.908		
Scope Of Supply	Piece	Article No.
Hose Clamp B9 W2 16-25 mm	30	303291
Hose Clamp B9 W2 20-32 mm	20	303305
Hose Clamp B9 W2 25-40 mm	20	303313
Hose Clamp B9 W2 32-50 mm	10	303321
Hose Clamp B9 W2 12-20 mm	20	303283
Accessories Available	PU Amount	Article No.
KE 3421 HOSE CLAMPS SORT.	1	040615



Berner Assortment 4012 Hose Clamps Mini S

Scope Of Delivery

- 10 dimensions
- 200 parts

Title	PU Piece	Article No.
BS 4012 PCSD CLIPS	1	874470

AGR: 07.908

Scope Of Supply	Piece	Article No.
Fuel Hose Clamps MINI Aba MINI S wide 9 mm, Ø 8 mm	20	193224
Fuel Hose Clamps MINI Aba MINI S wide 9 mm, Ø 9 mm	20	015016
Fuel Hose Clamps MINI Aba MINI S wide 9 mm, Ø 10 mm	20	015024
Fuel Hose Clamps MINI Aba MINI S wide 9 mm, Ø 11 mm	20	015032
Fuel Hose Clamps MINI Aba MINI S wide 9 mm, Ø 12 mm	20	015040
Fuel Hose Clamps MINI Aba MINI S wide 9 mm, Ø 13 mm	20	015059
Fuel Hose Clamps MINI Aba MINI S wide 9 mm, Ø 14 mm	20	015067
Fuel Hose Clamps MINI Aba MINI S wide 9 mm, Ø 15 mm	20	015075
Fuel Hose Clamps MINI Aba MINI S wide 9 mm, Ø 16 mm	20	015083
Fuel Hose Clamps MINI Aba MINI S wide 9 mm, Ø 18 mm	20	015105



Berner Assortment 4013 RSGU Clips

Scope Of Delivery

- 10 dimensions
- 120 parts

Title	PU Piece	Article No.
BS 4013 RSGU CLIPS	1	874463

AGR: 07.908

Scope Of Supply	Piece	Article No.
Rubber pipe clamp RSGU M5 6 mm	15	022764
Rubber pipe clamp RSGU M4 8 mm	15	022640
Rubber pipe clamp RSGU M5 8 mm	15	022772
Rubber pipe clamp RSGU M4 10 mm	15	022667
Rubber pipe clamp RSGU M5 10 mm	15	022799
Rubber pipe clamp RSGU M5 12 mm	10	022810
Rubber pipe clamp RSGU M5 15 mm	10	022837
Rubber pipe clamp RSGU M5 18 mm	10	022853
Rubber pipe clamp RSGU M5 20 mm	10	022870
PIPE CLP.RSGU 1100 24/12	5	545406



Berner Assortment 4015 Hose Connection Piece

Scope Of Delivery

- 10 dimensions
- 235 parts

Title	PU Piece	Article No.
BS 4015 HOSE CONN.PIECE	1	874371
AGR: 07.908		
Scope Of Supply	Piece	Article No.
FIL F.SCREEN WASH TUBE	10	877488
Straight Hose Connector Nozzle Typ GS 4	25	869797
Straight Hose Connector Nozzle Typ GS 5	25	869803
Straight Hose Connector Nozzle GS 6	25	814210
T-Hose Connector Nozzle Typ TS 4	25	869810
T-Hose Connector Nozzle Typ TS 5	25	814318
T-Hose Connector Nozzle Typ TS 6	25	863016
Y-Hose Connector Nozzle Typ YS 4	25	814350
Y-Hose Connector Nozzle Typ YS 5	25	869841
Y-Hose Connector Nozzle Typ YS 6	25	863023



Berner Assortment 3050 Cable Tapes

Scope Of Delivery

- 6 dimensions
- 300 parts

Title	PU Piece	Article No.
BS 3050 CABLE TAPES	1	807362

AGR: 07.904

Scope Of Supply	Piece	Article No.
Cable Strap 202 x 3,6 mm natural	50	019747
Cable Strap 150 x 3,6 mm natural	50	019739
Cable Strap 150 x 3,6 mm black	50	772399
Cable Strap 202 x 3,6 mm black	50	182853
Cable Strap 286 x 4,8 mm black	50	113820
Cable Strap 286 x 4,8 mm natural	50	019755

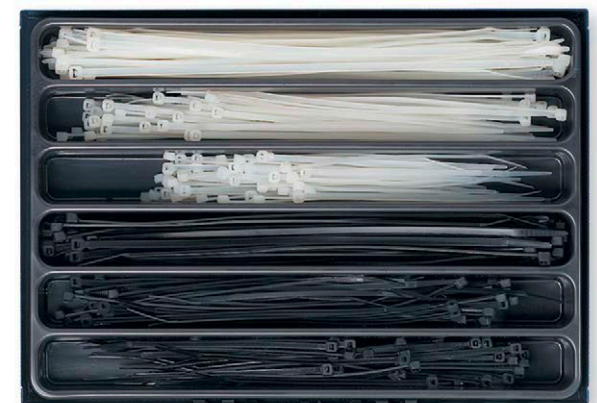

BS 3066 Cable Entry Grommets (Small)

Hints

- Also available as refill assortment without case

Scope Of Delivery

- 10 Dimensions
- 1 plastic insert
- 1 BS-assortment case
- 280 parts



Title	PU Assortment	Article No.
BS 3066 Cable Entry Grommets (small)	1	235393
AGR: 07.904		
Scope Of Supply	Piece	Article No.
Cable Entry Grommets 6634	50	163694
Cable Entry Grommets 6632	50	013293
Cable Entry Grommets 6646	50	013307
Cable Entry Grommets 6648	50	013315
Cable Entry Grommets 6650	25	013323
Cable Entry Grommets 6652	25	013331
Cable Entry Grommets 6662	10	013340
Cable Entry Grommets 6663	10	013358
Cable Entry Grommets 6665	5	013366
Cable Entry Grommets 6666	5	013374

INTERNAL/Approved (2019-03-23 00:03:37)

BS assortments

BS 3067 Cable Entry Grommets (large)

Scope Of Delivery

- 10 Dimensions
- 560 parts



Title	PU Assortment	Article No.
BS 3067 Cable Entry Grommets large	1	235407

AGR: 07.904

Scope Of Supply	Piece	Article No.
Cable Entry Grommets 6634	100	163694
Cable Entry Grommets 6632	100	013293
Cable Entry Grommets 6646	100	013307
Cable Entry Grommets 6648	100	013315
Cable Entry Grommets 6650	50	013323
Cable Entry Grommets 6652	50	013331
Cable Entry Grommets 6662	20	013340
Cable Entry Grommets 6663	40	013358
Cable Entry Grommets 6665	10	013366
Cable Entry Grommets 6666	10	013374

BS 3068 Blind Plugs

Hints

- Also available as refill assortment without case

Scope Of Delivery

- 6 Dimensions
- 420



Title	PU Assortment	Article No.
BS 3068 Blind Plugs	1	235423
AGR: 07.904		
Scope Of Supply	Piece	Article No.
Blind Plugs 6 mm	100	013404
Blind Plugs 8 mm	100	013390
Blind Plugs 10 mm	100	013412
Blind Plugs 12 mm	50	013420
Blind Plugs 14 mm	50	013382
Blind Plugs 20 mm	20	321052

Cable Connector Isolated

Scope Of Delivery

- 13 dimensions
- 476 parts

Title	PU Assortment	Article No.
BS 3051 CABLE CONN. RANGE	1	232564

AGR: 07.904

Scope Of Supply	Piece	Article No.
UNIVERSAL CRIMPING PLIER	1	201222
Insulated Connector 3329	50	012335
Insulated Connector 3318	25	012300
Insulated Connector 3303	50	012416
Insulated Connector 3304	25	012513
Branch Connector 5201	20	013153
Insulated Connector 3107	25	012670
Insulated Connector 3302	50	012432
Insulated Connector 3311	25	012351
Insulated Connector 3313	50	012610
Insulated Connector 3328	50	012394
Insulated Connector 3320	25	012254
Insulated Connector 3321	50	012270
Insulated Connector 3111	50	012602

Accessories Available	PU Amount	Article No.
KE 3051 CABLE CONN. SORT	1	040607



Berner Assortment 4019 Sleeves

Scope Of Delivery

- 12 dimensions
- 951 parts

Title	PU Piece	Article No.
BS 4019 STRAND END SLEEVES	1	157523

AGR: 07.904

Scope Of Supply	Piece	Article No.
Ferrule DIN46228 0,75 mm blue length 14mm	50	774294
Ferrule 417 1,5x12 mm	100	336750
Ferrule 415 1,5x7 mm	100	336734
Ferrule DIN46228 6 mm yellow	50	774006
Board Connector Pliers 153	1	001397
Ferrule 412 0,75x10 mm	100	336700
Ferrule 414 1x10 mm	100	336726
Ferrule 416 1,5x10 mm	100	336742
Ferrule 418 2,5x7 mm	100	336769
Ferrule 419 2,5x12 mm	100	336777
Ferrule DIN452 1 mm red	50	773832
Ferrule DIN46228 2,5 mm blue length 15 mm	50	774480
Ferrule DIN453 1,5 mm black	50	773840



INTERNAL/Approved (2019-03-23 00:04:21)

BS assortments

Berner Assortment 4020 Claws/Soldering Cable Shoe

Scope Of Delivery

- 10 dimensions
- 140 parts

Title	PU Piece	Article No.
BS 4020 CLAWS/SOLDERED CAB SH	1	157591

AGR: 07.904

Scope Of Supply	Piece	Article No.
Ring Cable Lug 4703	30	032679
Ring Cable Lug 4906 16 mm ² /6 VDE	10	032834
Ring Cable Lug 4918 50 mm ² /10 VDE	5	032848
Ring Cable Lug 4702	30	032678
Ring Cable Lug 4907 16 mm ² /8 VDE	10	032835
Ring Cable Lug 4908 16 mm ² /10 VDE	10	032836
Ring Cable Lug 4914 35 mm ² /8 VDE	10	032843
Ring Cable Lug 4915 35 mm ² /10 VDE	10	032844
TUBULAR LUG 4923 Ø95/8 VDE	5	032856
Ring Cable Lug 4704	20	032680



BS 3052 HEAT SHRINK TOOL

Hints

- Also available as a refill assortment without case

Scope Of Delivery

- 8 Dimensions
- 1 lighter
- 1 plastic insert
- 1 BS-assortment case
- 131 parts



Title	PU Assortment	Article No.
BS 3052 heat shrink tubing	1	317233

AGR: 07.904

Scope Of Supply	Piece	Article No.
Heat Shrink Tubes 2,4x100 mm	20	318248
Heat Shrink Tubes 3,2x100 mm	20	318256
Heat Shrink Tubes 4,8x100 mm	20	318264
Heat Shrink Tubes 6,4x100 mm	20	318272
Heat Shrink Tubes 9,5x100 mm	20	318280
Heat Shrink Tubes 12,7x100 mm	10	318299
Heat Shrink Tubes 19x100 mm	10	318302
Heat Shrink Tubes 25,4x100 mm	10	318310

Accessories Available	PU Amount	Article No.
KE 3052 HEAT SHRINK.HOSES	1	040608

INTERNAL/Approved (2019-03-23 00:04:37)

BS 3053 FLAT SKT FUSE

Hints

- Also available as a refill assortment without case

Scope Of Delivery

- 8 currents
- 1 plastic insert
- 1 BS-assortment case
- 205 parts



Title	PU Assortment	Article No.
BS 3053 Flat Plug-In Fuses	1	235369

AGR: 07.904

Scope Of Supply	Piece	Article No.
Blade-Type Fuse 3A violet normal	10	138804
Blade-Type Fuse 5A light brown normal	10	138806
Blade-Type Fuse 7,5A brown normal	25	138807
Blade-Type Fuse 10 A red normal	50	138808
Blade-Type Fuse 15 A light brown normal	50	138809
Blade-Type Fuse 20 A yellow normal	25	138810
Blade-Type Fuse 25 A nature normal	10	138811
Blade-Type Fuse 30 A green normal	10	138812

Accessories Available	PU Amount	Article No.
KE 3052 FLAT SKT FUSE	1	040609

Berner Assortment 4016 Mini-Max Plug-In Fuse

Scope Of Delivery

- 13 dimensions
- 125 parts

Title	PU Piece	Article No.
BS 4016 MINI-MAXI PLUG-IN FUSE	1	103216

AGR: 07.904

Scope Of Supply	Piece	Article No.
Blade-Type Fuse 15A light blue mini	15	768464
Blade-Type Fuse 20A yellow maxi	5	781690
Blade-Type Fuse 30A light green maxi	5	781738
Blade-Type Fuse 40A orange maxi	5	781720
Blade-Type Fuse 10A red mini	15	768456
Blade-Type Fuse 20A yellow mini	15	768472
Blade-Type Fuse 25A natur mini	10	768480
Blade-Type Fuse 30A light green mini	10	768499
Blade-Type Fuse 3A violet mini	10	781754
Blade-Type Fuse 5A light brown mini	10	768430
Blade-Type Fuse 7,5A brown mini	15	768448
Blade-Type Fuse 50A red maxi	5	781711
Blade-Type Fuse 60A blau maxi	5	781703



Berner Assortment 4018 Fuses Small-Mini

Scope Of Delivery

- 17 dimensions
- 276 parts

Title	PU Assortment	Article No.
BS 4018 BLADE FUSES SM-MINI	1	092872

AGR: 07.904

Scope Of Supply	Piece	Article No.
Blade-Type Fuse 7,5A braun super-mini	10	037209
Blade-Type Fuse 20A yellow super-mini	10	037212
Blade-Type Fuse 30A green super-mini	10	037214
Blade-Type Fuse 15A light blue mini	25	768464
Blade-Type Fuse 30A light green mini	25	768499
Blade-Type Fuse 3A violet mini	10	781754
Blade-Type Fuse 4A rose mini	10	930636
Blade-Type Fuse 25A transparent super-mini	10	037213
Tester for Blade-Type Fuses	1	138840
Blade-Type Fuse 10A red mini	25	768456
Blade-Type Fuse 20A yellow mini	25	768472
Blade-Type Fuse 25A natur mini	25	768480
Blade-Type Fuse 2A grau mini	10	930628
Blade-Type Fuse 5A light brown mini	25	768430
Blade-Type Fuse 7,5A brown mini	25	768448
Blade-Type Fuse 10A red super-mini	10	037210
Blade-Type Fuse 15A blue super-mini	10	037211
Blade-Type Fuse 5A light brown super-mini	10	037208

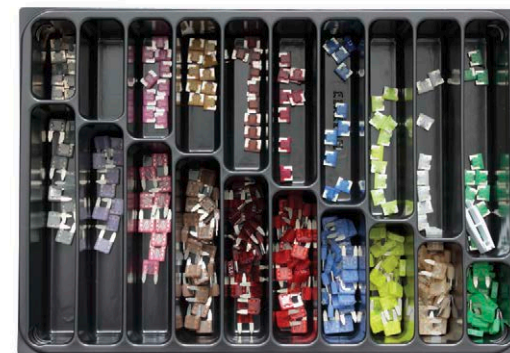

Berner Assortment 4022 Blade Fuse Standard-Maxi

Scope Of Delivery

- 18 dimensions
- 210 parts

Title	PU Assortment	Article No.
BS 4022 BLADE FUSE STD-MAXI	1	092788

AGR: 07.904

Scope Of Supply	Piece	Article No.
Blade-Type Fuse 1A black normal	15	138802
Blade-Type Fuse 2A grey normal	15	138803
Blade-Type Fuse 3A violet normal	15	138804
Blade-Type Fuse 4A rose normal	15	138805
Blade-Type Fuse 5A light brown normal	15	138806
Blade-Type Fuse 7,5A brown normal	15	138807
Blade-Type Fuse 10 A red normal	15	138808
Blade-Type Fuse 20 A yellow normal	15	138810
Blade-Type Fuse 30 A green normal	15	138812
Blade-Type Fuse 40 A orange normal	15	138813
Blade-Type Fuse 40A orange maxi	5	781720
Blade-Type Fuse 70A beige maxi	5	781746
Blade-Type Fuse 30A light green maxi	5	781738
Blade-Type Fuse 15 A light brown normal	15	138809
Blade-Type Fuse 25 A nature normal	15	138811
Blade-Type Fuse 20A yellow maxi	5	781690
Blade-Type Fuse 50A red maxi	5	781711
Blade-Type Fuse 60A blau maxi	5	781703

Accessories Available	PU Amount	Article No.
KE 4022 BLADE FUSE STD-MAXI	1	092790



INTERNAL/Approved (2019-03-23 00:05:20)

Berner Assortment 3140 Brake Pipe Nipple

Characteristics

- DIN flange E, single flange (BRT 005 & 006)
- DIN flange F, double flange (BRT 001-004
- BRT 007-012)
- Galvanized steel

Hints

- Also available as a refill assortment without case

Scope Of Delivery

- 12 Dimensions
- 1 plastic insert
- 1 BS-assortment case
- 110 parts



15

Title	PU Assortment	Article No.
BS 3140 Brake Pipe Nipple	1	221619

AGR: 07.903

Scope Of Supply	Piece	Article No.
Brake Pipe BRT 001 16,7 mm	20	222313
Brake Pipe BRT 002 24,8 mm	10	222399
Brake Pipe BRT 003 16,7 mm	10	222402
Brake Pipe BRT 004 20 mm	10	222410
Brake Pipe BRT 005 17,5 mm	5	222429
Brake Pipe BRT 006 17 mm	10	222437
Brake Pipe BRT 007 21 mm	10	222445
Brake Pipe BRT 008 19,5mm	10	222453
Brake Pipe BRT 009 18mm	10	222461
Brake Pipe BRT 010 18mm	5	222488
Brake Pipe BRT 011 18mm	10	222496
Brake Pipe BRT 012 14,2mm	5	222500

Berner Assortment 3141 Brake Bleeding Screw

Characteristics

- Galvanized steel

Scope Of Delivery

- 12 Dimensions
- 1 plastic insert
- 1 BS-assortment case
- 105 parts



Title	PU Assortment	Article No.
BS 3141 Brake Bleeder Screw	1	221627
AGR: 07.903		
Scope Of Supply	Piece	Article No.
Bleeding Screw BRT 030 30,5mm	10	221694
Bleeding Screw BRT 031 38,3mm	10	221813
Bleeding Screw BRT 032 30mm	5	221864
Bleeding Screw BRT 033 29mm	5	222038
Bleeding Screw BRT 034 34,3mm	5	222054
Bleeding Screw BRT 035 41,5mm	5	222100
Bleeding Screw BRT 036 32,4mm	10	222119
Bleeding Screw BRT 037 33,5mm	5	222127
Bleeding Screw BRT 038 24,5mm	5	222135
Bleeding Screw BRT 039 26,2mm	10	222143
Bleeding Screw BRT 040 28,7mm	5	222151
Rubber Cap BRT 042	30	222186

INTERNAL/Approved (2019-03-23 00:05:42)

Drill Bits Assortment 107 part DIN 338 **TOPline**

Hints

- Also available as a refill assortment without case

Scope Of Delivery

- 107 twist drill bits
- Each 10 piece 1.0 – 3.5 mm in gradients of 0.5 mm
- Each 5 piece 4.0 – 6.0 mm in gradients of 0.5 mm
- Each 3 piece 6.5 – 8.0 mm in gradients of 0.5 mm
- Each 2 piece 8.5 – 10.5 mm in gradients of 0.5 mm
- 20-fold in the BS-metal box



Title	PU Assortment	Article No.
BS 3044 TWIST D. 338 HSS GS	1	232556

AGR: 07.910

Scope Of Supply

	Piece	Article No.
Twist Drill Bit TOPline DIN 338 HSS 1.0 mm silver	10	131238
Twist Drill Bit TOPline DIN 338 HSS 1.5 mm silver	10	131244
Twist Drill Bit TOPline DIN 338 HSS 2.0 mm silver	10	131249
Twist Drill Bit TOPline DIN 338 HSS 2.5 mm silver	10	131254
Twist Drill Bit TOPline DIN 338 HSS 3.0 mm silver	10	131259
Twist Drill Bit TOPline DIN 338 HSS 3.5 mm silver	10	131264
Twist Drill Bit TOPline DIN 338 HSS 4.0 mm silver	5	131269
Twist Drill Bit TOPline DIN 338 HSS 4.5 mm silver	5	131274
Twist Drill Bit TOPline DIN 338 HSS 5.0 mm silver	5	131279
Twist Drill Bit TOPline DIN 338 HSS 5.5 mm silver	5	131284
Twist Drill Bit TOPline DIN 338 HSS 6.0 mm silver	5	131289
Twist Drill Bit TOPline DIN 338 HSS 6.5 mm silver	3	131294
Twist Drill Bit TOPline DIN 338 HSS 7.0 mm silver	3	131299
Twist Drill Bit TOPline DIN 338 HSS 7.5 mm silver	3	131304
Twist Drill Bit TOPline DIN 338 HSS 8.0 mm silver	3	131309

Scope Of Supply	Piece	Article No.
Twist Drill Bit TOPline DIN 338 HSS 8.5 mm silver	2	131314
Twist Drill Bit TOPline DIN 338 HSS 9.0 mm silver	2	131326
Twist Drill Bit TOPline DIN 338 HSS 9.5 mm silver	2	131331
Twist Drill Bit TOPline DIN 338 HSS 10.0 mm silver	2	131339
Twist Drill Bit TOPline DIN 338 HSS 10.5 mm silver	2	131341
Accessories Available	PU Amount	Article No.
KE 3044 DRILL DIN 338	1	040586

BS 3199 Rapid Mounting System

- x

Scope Of Delivery

- 12 Dimensions
- 1 plastic insert
- 1 BS-assortment case
- 48 parts



Title	PU Assortment	Article No.
BS 3199 Rapid Mounting System	1	000676

AGR: 07.914

Scope Of Supply	Piece	Article No.
BS 3081 EMPTY 12-COMPT.	1	234818
Ginding disc SPSS 50 mm P36	5	139485
Abrasive Mop Disc SSPS 50 mm P40	4	175751
Fleece Discs SSPS 50 mm coarse	5	139497
Mini-Flexidisc SSPS 50 mm P40	3	173165
Cleaning disc SPSS 50 mm	3	139500
Ginding disc SPSS 50 mm P60	5	139487
Abrasive Mop Disc SSPS 50 mm P60	4	175752
Ginding disc SPSS 50 mm P80	5	139488
Fleece Discs SSPS 50 mm medium	5	139496
Fleece Discs SSPS 50 mm fine	5	139495
Support pad SSPS 50 mm	1	139508
Mini-Flexidisc SSPS 50 mm P60	3	173167

Berner Assortment 3043 VW

Scope Of Delivery

- 12 dimensions
- 360 parts

Title	PU Assortment	Article No.
BS 3043 ASSORTMENT VW	1	102050

AGR: 07.903

Scope Of Supply	Piece	Article No.
Expansion rivet VW 8L0807300	20	167466
TRIM STRIP CLIP VW 1H0853585B	10	144706
Speed Nut VW 3B0868243	20	155300
PLUG-IN NUT GR.RD Ø4,2 HOLE7X7	50	153891
Door Lining Clip VW 8E0868243	10	002281
Door Lining Clip VW 6Q0868243	15	002334
Speed Nut VW N90821401	50	153894
Speed Nut Ø 4,2 7x7	50	153892
RIVET 8X11,5 H16	50	144662
Paneling clip VW 6X0867300A	25	001974
TRIM STRIP CLIP VW 1H0853585	10	144705
Speed Nut VW N90833801	50	001975



BS 3048 Opel Range

Scope Of Delivery

- 12 dimensions
- 475 parts

Title	PU Assortment	Article No.
BS 3048 ASSORTMENT OPEL	1	131351

AGR: 07.903

Scope Of Supply	Piece	Article No.
Expanding Rivet 5,5x11 Ø 16	50	619702
Expanding Rivet 6x20 Ø 15	25	151676
Plastic Nut Ø 4,5/Ø 16	50	155279
Expanding Rivet 5x7 Ø 9	50	079685
Clip 2345959	25	001715
Clip Interior Trim Opel	25	092433
Bumper Clip Opel 1406984	25	151683
Closing Plug 6,5x16 Ø 14	50	138139
Expanding Rivet 6x11,5 Ø 10	50	151685
Expanding Rivet 6x20 Ø 20	25	151674
Expanding Rivet 8x10 Ø 16	50	156892
RIVET 8X11,5 H16	50	144662



BS 3094 Sheet Metal Screws and Nuts

Hints

- Also available as refill assortment without case

Scope Of Delivery

- 12 Dimensions
- 1 plastic insert
- 1 BS-assortment case
- 925 parts



Title	PU Assortment	Article No.
BS 3094 Sheet Screws and Nuts	1	280259
AGR: 07.903		
Scope Of Supply	Piece	Article No.
Sheet Metal Screw 4,8x19	50	079995
Sheet Metal Screw 5,5x13	50	273600
Sheet Metal Screw 5,6x19	50	079952
Sheet Metal Screw 6,3x16	50	079413
Sheet Metal Screw 6,3x19	50	079405
Sheet Metal Nut 16 x11 Ø 3,5	100	078840
Sheet Metal Nut 16x11 Ø 4,2	100	078883
Sheet Metal Nut 15x12 Ø 4,8	100	078921
Sheet Metal Nut 20,5x13,2 Ø 4,8	100	079618
Sheet Metal Nut 20x13 Ø 5,6	100	078948
Sheet Metal Nut 24,5x14,5 Ø 6,5	100	078972
Sheet Metal Nut 25x16 Ø 6,5	75	078964
Accessories Available	PU Amount	Article No.
KE 3094 BL-SCR.A.METAL NUT	1	040570

INTERNAL/Approved (2019-03-23 00:07:00)

BS assortments

BS 3166 Universal Cover Caps

Hints

- Also available as a refill without case (prod. no. 169398)

Scope Of Delivery

- 6 Dimensions
- 1 plastic insert
- 1 BS-assortment case
- 150 parts



Title	PU Assortment	Article No.
BS 3166 Universal Cover Caps	1	167004

AGR: 07.907

Scope Of Supply	Piece	Article No.
Caps (Closing Plugs) 7x14 Ø 20	25	153944
Caps (Closing Plugs) 6,5x15 Ø 20	25	620012
Caps 6,5x25 Ø 20	25	144499
Caps (Closing Plugs) 6,5x12 Ø 19	25	153259
Caps 8,5x17 Ø 24	25	144484
Caps Fiat 1301788800	25	106718

BS 3168 Universal Clips Rivet Nuts

Hints

- Also available as refill assortment without case

Scope Of Delivery

- 8 Dimensions
- 1 plastic insert
- 1 BS-assortment case
- 165 parts



Title	PU Assortment	Article No.
BS 3168 Universal-Clips Rivet Nuts	1	167003
AGR: 07.907		
Scope Of Supply	Piece	Article No.
Expanding Rivet 3,5x6,5 Ø 8	25	144679
Expanding Rivet 5x15 Ø 10	10	144678
Expanding Rivet 5,5x12 Ø 9,5	25	153984
Expanding Rivet 5,5x10 Ø 16	10	733970
Expanding Rivet 6x10 Ø 13	10	155035
Expanding Rivet 6,5x12 Ø 15	10	144462
Expanding Rivet VW/Audi N0385491	25	017297
Expanding Rivet 8x13 Ø 16	50	144461

BS assortments

BS 3310 VW/AUDI Hit Clip Assortment

Scope Of Delivery

- 12 Dimensions
- 1 plastic insert
- 1 BS-assortment case
- 220 parts



Title	PU Assortment	Article No.
BS 3310 VW/AUDI Hit Clip Assortment	1	092794

AGR: 16.104

Scope Of Supply

	Piece	Article No.
Underbody Clip VW/AUDI 4A0805121A	20	017303
Underbody Clip VW/AUDI 8D0805121B	20	017301
Underbody Clip VW/AUDI 8D0805121	10	017302
Speed Nut VW 3B0868243	20	155300
Insulation Panel Clip VW N90335004	20	144566
Underbody Clip VW/AUDI 4A0805163	20	017299
Sheet Metal Nut VW/AUDI 8D0805960	10	017300
Underbody Clip VW 357827998	20	155301
Speed Nut Ø 4,8 7x7	20	144653
Door Lining Clip VW N10516801	20	002282
Expanding Rivet 6x15 Ø 15	20	155246
Expanding Rivet VW/Audi N0385491	20	017297

Accessories Available

	PU Amount	Article No.
KE 3310 VW/AUDI SORT. HIT CLIP	1	105208

15

Assortment Superseal AMP 1.5 Plug+cap housing

- Protecting electrical connections against moisture and dirt
 - A good electrical connection is guaranteed
- In accordance with IEC 60529 and DIN 40050-9
- Protection class IP67
 - Completely protected against dust and against the effects of immersion

Scope Of Delivery

- Most common Superseal AMP connectors in a clear and practical assortment
- 11 different components
- 560 pieces



Title	PU Assortment	Article No.
BS 3110 Water Tight Plug-In Connector	1	169438

AGR: 07.904

Scope Of Supply	Piece	Article No.
Socket Housing 2 polar	10	166676
Pin Housing 2 polar	10	166671
Socket Housing 3 polar	10	166677
Pin Housing 3 polar	10	166672
Socket Housing 4 polar	10	166678
Pin Housing 4 polar	10	166673
Sealing green 1,4-1,7 mm	100	166669
Sealing yellow 1,8-2,4 mm	100	166670
Sealing red 2,6-3,3 mm	100	166668
Socket Contact 0,75-1,5 mm	100	166681
Pin housing 0,75-1,5 mm	100	166682
Plastic inlets 12 fold BS 3081	1	234800
BS Basic Box	1	167665



BS assortments

BS 3350 BMW Hit Clip Assortment

Scope Of Delivery

- 12 Dimensions
- 1 plastic insert
- 1 BS-assortment case
- 295 parts

Title	PU Assortment	Article No.
BS 3350 BMW Hit Clip Assortment	1	100800

AGR: 16.100



BS 3330 Ford Hit Clip Assortment

Scope Of Delivery

- 11 Dimensions
- 1 plastic insert
- 1 BS-assortment case
- 205 parts

Title	PU Assortment	Article No.
BS 3330 Ford Hit Clip Assortment	1	092792

AGR: 16.101



BS 3360 Mercedes Benz Hit Clip Assortment

Scope Of Delivery

- 12 sizes
- 1 plastic insert
- 1 BS-assortment case
- 300 parts

Title	PU Assortment	Article No.
BS 3360 Mercedes Benz Hit Clip Assortment	1	100799

AGR: 16.102



BS 3320 Opel Hit Clip Assortment

Scope Of Delivery

- 12 Dimensions
- 1 plastic insert
- 1 BS-assortment case
- 225 parts

Title	PU Assortment	Article No.
BS 3320 Opel Hit Clip Assortment	1	092793

AGR: 16.103



BS 3311 VW/AUDI Hit Clip Assortment

Scope Of Delivery

- 12 dimensions
- 1 plastic insert
- 1 BS-parts case
- 245 parts

Title	PU Assortment	Article No.
BS 3311 VW/AUDI Hit Clip Assortment	1	245446

AGR: 16.104



15

BS 3340 Renault Hit Clip Assortment

Scope Of Delivery

- 8 Dimensions
- 1 plastic insert
- 1 BS-assortment case
- 275 parts

Title	PU Assortment	Article No.
BS 3340 Renault Hit Clip Assortment	1	100801

AGR: 16.111



Tool cases

System Box SMART-BOX empty

- Sturdy plastic box with 2 quick-release fasteners of metal
- Built-in handle
- labeling field
- The interior dimensions are identical to the drawer of the trolley Evolution
- Ideal for tool assortments in foam linings (eg, size A, A, B)

Hints

- SMART-BOX Size 1 for inlets of the sizes 110 x 337 mm
- SMART-BOX Size 2 for inlets of the sizes 228 x 337 mm



Title	Height, External	Depth, Exterior	External Width	PU Piece	Article No.
Smart-Box Size. 1 empty	80 mm	160 mm	360 mm	1	040935
Open-Jawed and Ring Ratchet Wrench	80 mm	280 mm	360 mm	1	043572
SMART-BOX XL	92 mm	420 mm	620 mm	1	188017

AGR: 07.512

Plastic Box With Cover

Characteristics

- Blue plastic box with a detachable lid

Technical Data

Color black / blue



Title	PU Piece	Article No.
PLASTICS-BOXWITH COVER	1	885932

AGR: 07.010

Tool cases

A 42 Aluminum Case

Characteristics

- Versatile applicable transportation and storage container
- Especially stable industrial design with stiffener beads, stacking corner, rubber sealing, cover strap, drop handles

Technical Data

Material	Aluminium
Color	Silver



Title	Length x width x height	PU Piece	Article No.
A 42 ALU-CASE 600X400X240	600 x 400 x 240 mm	1	155693
A 73 ALU-CASE 600X400X400	600 x 400 x 400 mm	1	155694
A 157 ALU-CASE 800X600X400	800 x 600 x 400 mm	1	155696
A 81 ALU-CASE 800X400X330	800 x 400 x 330 mm	1	155695

AGR: 07.512

Steel Plate Case

Characteristics

- A lot of space or big tool-ranges and devices
- Non-twistable construction
- Permanent fittings
- Secured hinges
- rounded edges
- Variable lid when fully opened
- Comfortable carrying handles also for two-handed carrying
- Careful inner lining
- Insert tray and perforated wall for small tools
- Lockable with a padlock



Title	Height, External	Depth, Exterior	External Width	PU Piece	Article No.
STEEL PLATE CASE A 910	432 mm	532 mm	910 mm	1	808536

AGR: 07.512

Tool cases

Toolbox Tinner

- This spacious and light case is a secure storage place for tools during work
- With carrying strap

Technical Data

Material	Sheet steel
Color	Blue



Title	Length x width x height	PU Piece	Article No.
TOOLBOX TINNER AGR: 07.512	600 x 200 x 215 mm	1	081489

15

Toolbox „8245“

Application Area

- For safe storage of tools

Characteristics

- Stable carrying handle, 5 storage compartments

Technical Data

Material	Steel
Color	Blue



Title	Length x width x height	PU Piece	Article No.
Toolbox „8245“ AGR: 07.512	530 x 200 x 200 mm	1	915335

Basic Toolbox

Application Area

- For safe storage of tools

Characteristics

- Variable bottom tray, removable document storage A4 format, removable tool board, 31 tool pockets with covers, removable cover plate for bottom tray with 15 tool pockets, aluminum frame with impact border protection, high impact resistant ABS material, 2 lockable tilt locks, 1 number-lock

Technical Data

Color black

15

INTERNAL/Approved (2019-03-23 00:09:42)

Title	Length x width x height	Weight	Volume, Gross	PU Piece	Article No.
Basic Toolbox	480 x 380 x 180 mm	4 kg	26 l	1	023017

AGR: 07.512

Tool cases

Spare Parts

	PU Piece	Article No.
CLIP LOOK TOOL SUIT SASE	1	200099
HANDLE FOR TOOL SUIT CASE	1	199639

Leather Tool Bag

Application Area

- For safe storage of tools

Characteristics

- Bag with central separator, bag body reinforced with aluminium corners, bottom tray made of zinc plated steel sheet, tool holder on the front-, back- and sidewalls, front pocket, ring caps



Technical Data

Material	Leather
Content (Product Field)	Hand tools

Title	Length x width x height	PU Piece	Article No.
ELECTRICIAN TOOL BAG	460 x 205 x 330 mm	1	874968

AGR: 07.501

Scope Of Supply

	Piece	Article No.
Leather Tool Bag 435 x 180 x 270	1	023020
Water Level Topline 40 cm	1	113472
Junior Sawframe 240 mm	1	046299
CABLE KNIFE 486001	1	103384
VDE-Abisolierzange 3K	1	188102
Heavy-Duty Multi Purpose Plier 3K 180 mm	1	188076
VDE-Seitenschneider 3K	1	188084
Locksmith's Hammer	1	244581
Sledge Hammer	1	244601
Screw driver voltage tester SL	1	218559
Screw driver 2K VDE SL 4,0x100	1	218520
Screw driver 2K VDE SL 5,5x125	1	218521
Screw driver 2K VDE PH 1x80	1	218526
Screw driver 2K VDE PH 2x100	1	218527
SLOTING CHIS. 230LX28	1	135532

INTERNAL/Approved (2019-03-23 00:10:18)

Tool cases

Tool Box Small Cloth

- Robust and durable fabric
- Tool bag from dirt completely closed
- Removable top
- Receptacle for a spirit level
- 2 plastic boxes with 6 compartments for small parts
- Comfortable handle and shoulder strap

Application Area

- To use for service or the like to store easily and quickly die and always in the right place to have

Hints

- Max. Carrying load of the shoulder strap: 30 kg



15

Title	Length x width x height	PU Piece	Article No.
TOOL BOX SMALL	420 x 230 x 260 mm	1	111058
AGR: 07.512			
Spare Parts		PU Amount	Article No.
Strap for Tool Bag		1	216386

Tool Bag Cloth Big 17"

- Solid and durable fabric
- Tool pocket against dirt compleatly sealable
- Detachable cover
- Outside pocket with a velcro sealing
- Inside compartments and stitched-down straps for tool uptakes
- Comfortable carrying handle and shoulder strap

Application Area

- Practical, big shoulder bag for tools and mounting accessories

Hints

- Stable plastic bottom protects against moisture



Title	Length x width x height	PU Piece	Article No.
17 POCKET TOOL BAG AGR: 07.512	450 x 250 x 300 mm	1	152981

Tool cases

Spare Parts

Strap for Tool Bag

PU
Amount

Article No.

1

216386

Tool backbag trolley

- Maximum flexibility
 - ▶ A tool backpack and a trolley
 - ▶ Several outer pockets and options for tool storage
 - ▶ Spacious interior compartments, extra pocket for laptop
 - ▶ Easily removable inlet to take tools separately from the backpack
- Robust and practical
 - ▶ 2 stable twin wheels
 - ▶ Double-sided closing zipper
 - ▶ Waterproof plastic base provides high protection against moisture and dirt
 - ▶ Padded, breathable back and shoulder
 - ▶ telescopic handle and sturdy sheathed carrying handle
 - ▶ Guarantees the best conditions to transport tools everywhere, in all situations



Title	Length x width x height	Weight	Max load capacity	PU Piece	Article No.
Tool backbag trolley	340 x 190 x 500 mm	3.1 kg	15 kg	1	341698

AGR: 07.500

Tool Box Easy 445

- Easy and compact
 - ▶ Small model of the entry range with 445 mm length
 - ▶ Multipurpose for storing tools, accessories, consumables
 - ▶ With plastic closures
- Robust
 - ▶ Made of sturdy plastic
- Removable tool tray
 - ▶ Increases storage capacity
- Innovative locking system with handle
 - ▶ Plastic closure in open position can be used to lift the box
 - ▶ Prevents content from toppling
 - ▶ Retractable handle



Hints

- Easy and comfortable to carry on the shoulder thanks to the strap that is available. Good to get your hands free (accessory sold separately).

Title	Length x width x height	Max load capacity	PU Piece	Article No.
Tool Box Easy 445	445 x 230 x 235 mm	15 kg	1	341700

AGR: 07.512

Accessories Available

	PU Amount	Article No.
Berner strap for Toolbox Easy	1	367831

Spare Parts

	PU Piece	Article No.
Spare part Kit for tool box Easy 445	1	367223

Tool cases

Tool Box Easy 580 **STANDARD**line

- Easy and compact
 - ▶ Second model of the entry range with a 580 mm length
 - ▶ Multipurpose for storing tools, accessories, consumables
- Robust
 - ▶ Made of sturdy plastic
 - ▶ With plastic closures
- Optimised storage organization
 - ▶ Removable tool tray
 - ▶ Increased storage capacity
 - ▶ Compartment for small parts
- Innovative locking system with handle
 - ▶ Plastic closure can be used to lift the box in open position
 - ▶ Prevents content from toppling
 - ▶ Retractable handle



Hints

- Easy and comfortable to carry on the shoulder thanks to the strap that is available. Good to get your hands free (accessory sold separately).

15

Title	Length x width x height	Max load capacity	PU Piece	Article No.
Tool Box Easy 580	580 x 290 x 285 mm	17 kg	1	341701
AGR: 07.512				
Scope Of Supply			Amount	Article No.
C-part box for trolley case			1	-
Accessories Available			PU Amount	Article No.
Berner strap for Toolbox Easy			1	367831
Spare Parts			PU Piece	Article No.
Spare part Kits for tool box Easy 580			1	368456

Tool Box Premium 650

- High storage capacity
 - ▶ 650 mm length
 - ▶ Removable tool tray to increase storage capacity
 - ▶ Multipurpose for storing tools, accessories, consumables
- Robust and well designed
 - ▶ Made of sturdy plastic, with metal closures
 - ▶ Lockable with a padlock
- Innovative locking system with handle
 - ▶ Plastic closure can be used to lift the box in open position
 - ▶ Prevents content from toppling
 - ▶ Retractable handle
- Dimensional display on the top of the lid



Title	Length x width x height	Max load capacity	PU Piece	Article No.
Tool Box Premium 650	650 x 300 x 295 mm	20 kg	1	341702

AGR: 07.512

Spare Parts

	PU Piece	Article No.
Spare part kit for tool box Premium	1	367224

Tool cases

Tool Box Big Trolley 775

- Giant tool trolley
 - ▶ Especially suitable for bulky and heavy tools
 - ▶ Useful volume of 180 L
- Easy to transport
 - ▶ Sliding telescopic steel handle
 - ▶ 2 solid rubber wheels
- Handy organization
 - ▶ Large plastic closures
 - ▶ 2 removable tool trays
 - ▶ 2 removable C part compartment boxes



15

Title	Length x width x height	Max load capacity	PU Piece	Article No.
Tool Box Big Trolley 775	775 x 472 x 493 mm	50 kg	1	341699
AGR: 07.512				
Scope Of Supply			Amount	Article No.
C part box for tool box Easy			2	367232
Spare Parts			PU Piece	Article No.
Spare part kit for tool box big trolley 775			1	367225
C part box for tool box Easy			1	367232

Tool Box Tower Trolley

- Adaptable everywhere
 - ▶ Spacious rolling tower of 2 separable toolboxes with 2 organizers on the lid
- Easy to transport
 - ▶ Sliding telescopic plastic handle
 - ▶ 2 solid rubber wheels
 - ▶ Compact dimension with high storage capacity
 - ▶ Practical to maneuver in small areas
- Handy organization
 - ▶ Large metal closures
 - ▶ 2 different big toolboxes to organize the tools
 - ▶ 1 removable tool tray
 - ▶ 1 removable C part compartment box



Title	Length x width x height	Max load capacity	PU Piece	Article No.
Tool Box Tower Trolley	470 x 290 x 630 mm	30 kg	1	341703
AGR: 07.512				
Scope Of Supply			Amount	Article No.
C-part box for trolley case			1	-
Spare Parts			PU Piece	Article No.
Spare part kit for tool box tower trolley			1	367231

INTERNAL/Approved (2019-03-23 00:11:34)

Tool cases

Berner strap for toolbox Standard Line Easy 445 and 580

- Easy portage
 - A strap for a confort carry up of the toolbox on the shoulder
 - Allow to free the hands to carry other things arounds

Title	Length	Width	PU Piece	Article No.
Berner strap for Toolbox Easy	1.45 m	4 cm	1	367831

AGR: 07.512



C-part boxes and spare part kits for plastic cases Standard Line

- Replaceable spare part kits for easy repair of all Standard Line cases
- C-part boxes for all small pieces



Kit for tool box Premium

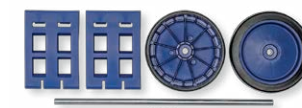

Kit for tool box big trolley 775



Kit for tool box tower trolley



C part box



C part box



Kit for tool box Easy 580

Title	PU Piece	Article No.
C part box for tool box Easy	1	367232
Spare part kit for tool box tower trolley	1	367231
Spare part kit for tool box big trolley 775	1	367225
Spare part Kits for tool box Easy 580	1	368456
Spare part Kit for tool box Easy 445	1	367223
Spare part kit for tool box Premium	1	367224

AGR: 07.512

Tool-case (ABS) **PREMIUM**line

- Very robust plastic case for high protection of tools
 - ▶ Made from high impact ABS material
 - ▶ Robust aluminium frame with hem protections
 - ▶ Bottom feet protect the shell from damage and offer a more stable standing position
 - ▶ A robust, comfortable handle provides the necessary comfort for carrying the case
- Security for tools
 - ▶ Metal lockable cliplocks (2 keys included)
 - ▶ Combination lock
- Efficient tool organization
 - ▶ Includes 3 removable inlays with dedicated spaces for tools
 - ▶ 1 inlay with document partition (A4) in the lid + 7 tool spaces
 - ▶ 1 tool inlay in the upper shell with 22 tool pockets
 - ▶ 1 tool inlay in the bottom shell cover with 15 tool pockets
 - ▶ Bottom tray space with dividers
 - ▶ Adaptable positioning of the dividers



15

Title	Length x width x height	Weight	Max load capacity	PU Piece	Article No.
Premium Tool-case (ABS)	495 x 355 x 195 mm	4.6 kg	25 kg	1	367219
Accessories Available				PU Amount	Article No.
Set of 2 aluminium dividers 440x60x30 for Premium Tool-Cases				1	368457

INTERNAL/Approved (2019-03-23 00:11:56)

Tool cases

Tool-case Mobile (ABS) **PREMIUM**line

- Ideal solution for off-site repairs
 - ▶ Easy transport, high capacity
 - ▶ Ergonomic telescopic handle
 - ▶ Equipped with 2 free running wheels
- Very robust plastic case for high protection of the tools
 - ▶ Made from high impact ABS material
 - ▶ Robust aluminium frame with hem protections
 - ▶ Bottom feet protect the shell from damage and offer a more stable standing position
 - ▶ A robust, comfortable handle provides the necessary comfort for carrying the case
- Security for tools
 - ▶ Metal lockable cliplocks (2 keys included)
 - ▶ Combination lock
- Efficient tool organization
 - ▶ Includes 3 removable inlays with dedicated spaces for tools
 - ▶ 1 inlay with document partition (A4) in the lid + 7 tool spaces
 - ▶ 1 tool inlay in the upper shell with 22 tool pockets
 - ▶ 1 tool inlay in the bottom shell cover with 15 tool pockets
 - ▶ Bottom tray space with dividers made of aluminium
 - ▶ Adaptable positioning of the dividers



15

Title	Length x width x height	Weight	Max load capacity	PU Piece	Article No.
Premium Tool-case Mobile (ABS)	515 x 440 x 255 mm	6.6 kg	30 kg	1	367220

AGR: 07.512

Accessories Available

	PU Amount	Article No.
Set of 3 aluminium dividers 470x70x30mm for Premium Tool-Cases	1	368458

INTERNAL/Approved (2019-03-23 00:12:01)

Backpack Tool Technic

- Allows technicians to easily move tools where needed
- Efficient tool organisation
 - ▶ First internal padded compartment equipped with a velcro strap for computers, tablets or documents
 - ▶ Second compartment with removable toolboard with 8 pockets and 2 rows of elastic loops specifically designed for vertical storage of tools + 1 lockable small pocket on the interior back
 - ▶ Large attached frontpocket with lockable zipper and 2 inside patch pockets and a key ring
- Resistant and comfortable use
 - ▶ Made of tear-proof nylon
 - ▶ Padded backpack system with abdominal and chest straps and cell phone pocket with hook-and-loop fixation
 - ▶ Rubberized flexible base with 5 feet for best resistance
 - ▶ Rubberized, ergonomic handle



Technical Data

Material	Nylon
Color	black

15

Title	Length x width x height	Weight	Max load capacity	PU Piece	Article No.
Backpack Tool Technic	350 x 230 x 430 mm	2.3 kg	12 kg	1	367218

AGR: 07.500

INTERNAL/Approved (2019-03-23 00:12:16)

Tool-case shock resistant (PP) **PREMIUM**line

- Strong outdoor tool case
 - ▶ Dustproof and waterproof, developed for hard conditions
 - ▶ Made of polypropylène (PP) for impact resistance
 - ▶ Temperature resistance from -30 to +80 degrees
- Efficient tool organization
 - ▶ Includes 1 fixed + 2 removable inlays with dedicated spaces for tools
 - ▶ 1 inlay for documents + 7 tool spaces in the lid
 - ▶ 1 tool inlay in the upper shell with 21 tool pockets
 - ▶ 1 tool inlay in the bottom shell cover with 12 tool pockets
 - ▶ Bottom tray space with dividers made of aluminium
 - ▶ Adaptable positioning of the dividers
- High quality finish
 - ▶ Shoulder strap for easy carrying
 - ▶ Ergonomic handle
 - ▶ Smooth latch
 - ▶ Certified IP67
 - ▶ Automatic air pressure and compensation valve



15

Title	Length x width x height	Weight	Max load capacity	PU Piece	Article No.
Premium Tool-case shock resistant (PP)	468 x 365 x 188 mm	4.7 kg	30 kg	1	367221
Accessories Available				PU Amount	Article No.
Set of 2 aluminium dividers 440x60x30 for Premium Tool-Cases				1	368457

INTERNAL/Approved (2019-03-23 00:12:22)

Tool-case Mobile shock resistant (PP) PREMIUMline

- Ideal rolling solution for outdoor repairs
 - ▶ Easy transport, high capacity
 - ▶ Ergonomic telescopic handle
 - ▶ Equipped with 2 free running wheels
- Strong outdoor tool case
 - ▶ Dustproof and waterproof, developed for hard conditions
 - ▶ Made of polypropylène (PP) for impact resistance
 - ▶ Temperature resistance from -30 to +80 degrees
- Efficient tool organization
 - ▶ Includes 1 fixed + 2 removal inlays with dedicated spaces for tools
 - ▶ 1 inlay for documents + 7 tool spaces in the lid
 - ▶ 1 tool inlay in the upper shell with 21 tool pockets
 - ▶ 1 tool inlay in the bottom shell cover with 12 tools pockets
 - ▶ Bottom tray space with dividers made of aluminium
 - ▶ Adaptable positioning of the dividers
- High quality finish
 - ▶ Shoulder strap for easy carrying
 - ▶ Ergonomic handle
 - ▶ Smooth latch
 - ▶ IP67 certified
 - ▶ Automatic air pressure and compensation valve
 - ▶ Gas springs



15

Title	Length x width x height	Weight	Max load capacity	PU Piece	Article No.
Prem.Tool-case Mobile shock resistant (PP)	609 x 428 x 263 mm	9.8 kg	50 kg	1	367222

AGR: 07.512

Accessories Available

	PU Amount	Article No.
Set of 3 aluminium dividers 470x70x30mm for Premium Tool-Cases	1	368458

INTERNAL/Approved (2019-03-23 00:12:39)

Divider sets for Premium tool cases

- Adaptable
 - ▶ Aluminium dividers create additional separations on the bottom of the cases
 - ▶ Complete sets with end and middle caps, cuttable to the size needed
 - ▶ Provide dedicated spaces according to the tool sizes or subdivisions for small parts



Application Area

- Premium tool cases

Processing Information

- Instruction manual available
- Measure the required length for the divider, from the scale to the middle of the divider
- Reduce the length by 15mm: the space is required for the end and middle caps
- Cut the divider at the calculated length
- Put on the middle and end caps, and fix the middle caps with the screws
- Put the divider into the bottom scale of your case

Set of 2 dividers, dimensions 440x60x30 mm

Set of 3 dividers, dimensions 470x70x30 mm

Hints

- Dimensions 440x60x30 : set of 2 dividers
Suitable for cases 367219 and 367221
- Dimensions 470x70x30 : set of 3 dividers
Suitable for cases 367220 and 367222

Technical Data

Material Aluminium

Title	PU Piece	Article No.
Set of 2 dividers 440x60x30 mm	1	368457
Set of 3 dividers 470x70x30 mm	1	368458

AGR: 07.512

Transport Case Plastic

- Lockable lid
- Splash-proof through seal around the cover
- Can be used in crafts, construction and landscaping
- Stable and weather-resistant
- Shockproof
- Transport box 450 L still has a side door that can be connected
- right
- Low weight and reduced fuel consumption

Application Area

- For safe storage of tools and building materials

Technical Data

Material Polypropylene (PP)



Title	Length x width x height	Weight	Volume, Gross	PU Piece	Article No.
Transport Case Plastic 450 L	1750 x 650 x 550 mm	3800 g	450 l	1	336034

AGR: 07.512

Tool cases

Transport Box Easy

- Very stable transportation box with a shutter
- Secure storage of the load on the flatbed vehicle
- Gas pressure absorber in the shutter
- Without separated false floor, therefore also suitable for big containers
- Broom, shovel, rake and so are securely stored in the box
- Protection guard, cleanliness and orderliness
- Protected against splash water

Technical Data

Content (Product Field) -without content-



15

Title	Length x width x height	PU Piece	Article No.
TRANSPORT BOX EASY 1700	1700 x 640 x 760 mm	1	209226*
TRANSPORT BOX EASY 1900	1900 x 640 x 760 mm	1	209227*

* = The delivery time is 14 days

AGR: 07.512

Transport Box Top

- Very stable transportation box with a shutter
- Secure storage of the load on the flatbed vehicle
- Gas pressure absorber in the shutter
- With separated false floor, therefore storage in both levels
- Double-sided doors for an easy lateral reach of the tools on the vehicle
- Broom, shovel, rake and so on in are stored in the lower box
- Protection guard, cleanliness and orderliness
- Protected against splash water

Technical Data

Content (Product Field) -without content-



Transport Box Premium

- Very stable transportation box with a shutter
- Secure storage of the load on the flatbed vehicle
- Gas pressure absorber in the shutter
- With separated false floor, therefore storage in both levels
- Double-sided doors for an easy lateral reach on the vehicle
- 3 solid pull-out drawers on the right side, for a better organization and quick readiness of tools
- Broom, shovel, rake and so are stored in the upper area
- Protection guard, cleanliness and orderliness
- Protected against splash water



Title	Length x width x height	PU Piece	Article No.
TRANSPORT BOX PREMIUM 1900	1900 x 640 x 760 mm	1	209229*

* = The delivery time is 14 days
 AGR: 07.512

INTERNAL/Approved (2019-03-23 00:13:09)

Transport Box Vario Roller Shutter

- Stable transportation box with a shutter
- Secure storage of the load sidewise on the flatbed vehicle
- 2 solid shutters, 2 tanks divided in the middle, big deposit with boxed
- Easy sidewise taking out of tools from the vehicle
- Protection guard, cleanliness and orderliness
- Protected against splash water



Title	Height	Width	Depth	PU Piece	Article No.
-------	--------	-------	-------	----------	-------------

Brass-Padlock Premium

- Very high quality
- High quality brass padlock with automatic Ironing locking, hardened shackle and precision pin tumbler
- brass lock, corrosion-resistant and resistant through double lock
- Automatic locking: lock without key by pressing down the strap
- Including two keys

Application Area

- Secure and seal of cases, canister, trunks, work benches, ..., To buildings, containers or the like

Hints

- Duplicate keys or spare keys only available form the key service
- Simultaneous locking not possible



Title	Width A	Ø bracket	Clear Width C	Clear Height D	PU Piece	Article No.
Brass-Padlock Premium 25	25 mm	4 mm	13.5 mm	23.5 mm	1	245119
Brass-Padlock Premium 30	30 mm	5 mm	16 mm	23 mm	1	245117
Brass-Padlock Premium 40	40 mm	6 mm	22 mm	24 mm	1	245116
Brass-Padlock Premium 50	50 mm	8 mm	28 mm	29 mm	1	245114
Brass-Padlock Premium 60	60 mm	9.5 mm	32 mm	36 mm	1	245113
Brass-Padlock Premium 92/60	60 mm	9.5 mm	32 mm	92 mm	1	245107

AGR: 08.102

Brass-Number Padlock

- Very high quality
- High quality brass padlock with automatic Locking latch, hardened shackle and precision pin cylinder
- Brass lock, corrosion-resistant and resistant by double lock
- Automatic locking: lock without key by pressing down the bow
- Individually adjustable, 4-digit number code
- Precision locking mechanism with additional measures to Protection against manipulation

Application Area

- Secure and seal of cases, canister, trunks, work benches, ..., To buildings, containers or the like

Scope Of Delivery

- Including key for the code change



Title	Width A	Ø bracket	Clear Width C	Clear Height D	PU Piece	Article No.
Brass Combination Lock	51 mm	8 mm	25 mm	26 mm	1	245108

AGR: 08.102

Further Storage systems and assortments

High Secure-Padlock A2

- Security lock made of stainless steel
- Bow and case made of stainless steel A2
- Highly resistant against accidental opening by double locking and anti-drilling
- Special locking mechanism with special key
- Absolute rust free, Weatherproof and robust
- Controlled closing: Only with key possible

Application Area

- Back up and closing of cases, trunks, cabinets, etc. also buildings, containers orlike this . espacial for outdoor

Scope Of Delivery

- 2 Key's



Title	Width A	Ø bracket	Clear Width C	Clear Height D	PU Piece	Article No.
High Secure-Lock A2	40 mm	6.5 mm	16 mm	23.5 mm	1	245105
High Secure-Lock A2	50 mm	9 mm	19 mm	33 mm	1	245104
High Secure-Lock A2	60 mm	10 mm	20 mm	40 mm	1	245103

AGR: 08.102

Door Frame Fixture Set 28 PCS

Application Area

- Installation of steel frame doors with stiffening pipes

Scope Of Delivery

- 4 screws DIN 933 M8x20
- 8 screws DIN 603 incl. Nut
- 8 flat washers DIN 125 M8
- 4 knock-in anchors SD-I 6x40
- 4 contact anchor M8x30

Title	PU Package	Article No.
DOOR FRAME FIXTURE SET 28 PCS	1	087749
AGR: 07.903		



Further Storage systems and assortments

Electrician Fastening Set Torx

- Practical and small package for the construction site

Application Area

- Surface installations (switches, cable ducts, lamps etc.)

Scope Of Delivery

- 100 pieces of chipboard screws Pan Head PZD 4,0 x 40 zi
- 100 pieces of dowel Universalfix 6 x 38 m. B.

Title	PU Package	Article No.
ELECTRICAL FASTENING SET TX	1	110114

AGR: 07.917



Electrician Fastening Set Pozidriv

- Practical and small package for the construction site

Application Area

- Surface installations (switches, cable ducts, lamps etc.)

Scope Of Delivery

- 100 pieces of chipboard screws Pan Head PZD 4,0 x 40 zi
- 100 pieces of dowel Universalfix 6 x 38 with collar

Title	PU Package	Article No.
ELECTRICAL FASTENING SET PZD	1	110115

AGR: 07.917

