

Craftsman Boy "Quick Lock" 500 Kg

- Fast release lever allows desired empty lift pre-selection per hand
- Fast adjustments as 1 turn of the crank mechanics = 4 cm lift change
- Can be delivered in 2 lengths
- Loadable up to 500 kg

Application Area

- Stable fast support for lifting, pressing, aligning and spreading

Characteristics

- 500-01 General attachment piece: support of the exhaust during mounting or demounting, 500-01 attachment piece: lifting, lowering the gearbox or in connection with the driving cart to transport, tiltable, adjustable in all directions in the width, standpipe with base plate: Welding on an existing underground, welding on the driving chart as bottom holder for the fast support Driving cart incl. standpipe: 4 ball beared rolls, 2 pieces with brakes, loadable up to 150 kg, size 55 x 55 cm





Title	Height, Min.	Height, Max.	Bearing Load, Max.	Mobile	PU Piece	Article No.
Craftsman-Boy	1100 mm	2000 mm	500 kg	Yes	1	071048
CRAFTSMAN HELP 170-300]CRANK[1700 mm	3000 mm	500 kg	Yes	1	149794
CRAFTSMAN HELP 80-140	800 mm	1400 mm	500 kg	Yes	1	149793

AGR: 08.001

Accessories Available

	PU Piece	Article No.
Standpipe 500-03	1	071072
Attachment Piece, General 500-01	1	071153

Attachment "general", "T", "Y"

Application Area

- Set of different attachment elements for various mounting and supporting elements

Title	Ø	PU Piece	Article No.
General Attachment Piece, General 500-01	40 mm	1	071153
PUSH-ON PART T	40 mm	1	071188
PUSH-ON PART Y	40 mm	1	071196

AGR: 08.001



Large Clamping Element

- Easy lifting of beams, panels, boards, scaffolds and frames
- Even vertical standing steel frames, wooden and aluminium screens can be placed from below in a safe, fast and very precise way

Title	Ø	PU Piece	Article No.
LARGE CLAMPING ELEMENT	40 mm	1	826660*

* = The delivery time is 28 days

AGR: 03.609



Standpipe

Application Area

- Standpipe with base plate for welding, onto an available base, e. g. car rim or undercarriage

Processing Information

- The quick-supporter will be inserted into the standpipe



Title	Ø	PU Piece	Article No.
Standpipe 500-03	40 mm	1	071072

AGR: 08.001

Quick Support

- Release lever for a quick feed motion
- Power clamp out of metal for a secure and firm clamping
- Rubberized base plate on both ends (13 x 8 cm)
- Ball joints for the uptake of the base plates
- Metal bar, extra hardened
- Solid steel pipe with a safety stop
- Stable outer steel pipe with special coating
- Fixing clamp for a large load
- Max. inclination of 25° per base plate

Application Area

- Quick and safe support of sheets or building components with only one hand



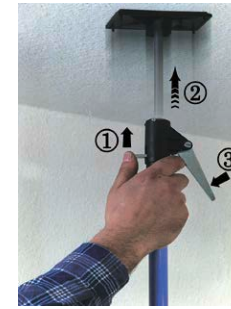

Title	Height, Min.	Height, Max.	Bearing Load, Max.	Footprint (L)	Footprint (B)	PU Piece	Article No.
QUICK-SUPPORT 145-290 CM	1450 mm	2900 mm	60 kg	130 mm	80 mm	1	209264

AGR: 08.001

Accessories Available

	PU Piece	Article No.
UNIVERSAL HOLDER, LASER/LAMPE	1	209262

Spare Parts

	PU Piece	Article No.
GROUND PLATE	1	209261

Hand Pump Dispenser 500ML

- Transparent pump body
- 10 ml scale classification allows controlled removal and filling
- Made in Germany

Application Area

- Filling and extraction of non-explosive media, e.g: Coolant, gear oil, diesel fuel, motor oil ...

Hints

- Not suitable for brake fluid, gasoline, aggressive hydraulic oil, acids and alkalis
- Completely emptied after each use
- Carefully clean the changing of the medium

Scope Of Delivery

- Hand dosing pump with 2 suction hoses and plug

Title	PU Piece	Article No.
SUCTION PUMP 500 ML	1	110722

AGR: 08.007

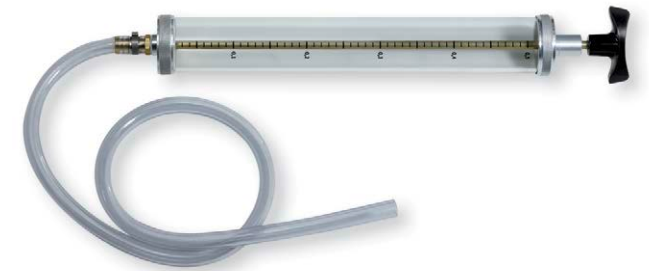
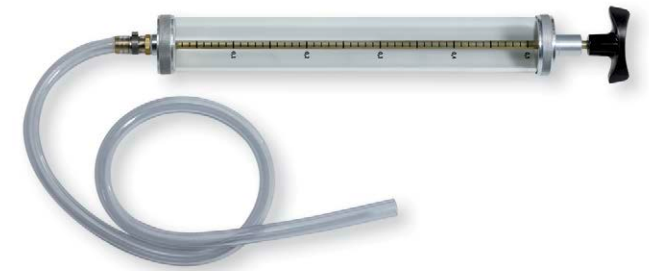

Fill- / sucking pump

- Transparent design for checking the liquids on dirt or abrasion
- Suitable for the suction and filling of liquids during the work temperature of the vehicle
- Screw cap for preventing a leakage of the liquid

Application Area

- For extracting and filling of non-explosive liquids of all kind except for brake fluid, antifreeze, gasoline, ...

Title	Capacity	Ø	Length	PU Piece	Article No.
FILLER DISPENSER 1500 ML	1.5 l	88 mm	500 mm	1	208126
AGR: 04.818					
Spare Parts				PU Amount	Article No.
Sealing set for 208126				1	339262

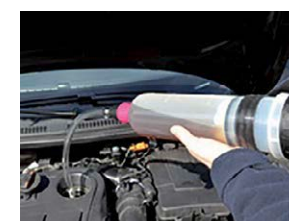

Metal Barrel Pump

- Suitable for oil-based fluids
- Fits all 60 - to 200-liter barrels
- Telescope pipe can be extended step-free

Characteristics

- Metal pump with plastic jacket handle

Hints

- Not suitable for fats, acids, petrol, water-based liquids, washer antifreeze, acidic and alkaline cleaners

Title	PU Piece	Article No.
Barrel Pump	1	706698
AGR: 08.007		
Accessories Available		PU Article No.
ADAPTER FOR BURREL-PUMP		1 003116



Plastic Barrel Pump

- Suitable for oil, diesel, antifreeze, water, washer antifreeze (in mixtures of 2: 1, 1: 1, 1: 2)
- Fits two different barrel thread
- Telescopic suction tube, thus variable lengths
- Low pump weight, so lightweight and portable
- Suitable for all 60 to 200 liter barrels with female thread

Characteristics

- Plastic jacket handle

Processing Information

- the length of the telescope suction pipe is 340 - 900 mm
- The Connection is G 2" and G 1.1/2"

Hints

- Not suitable for alkalis, acids, solvents and media of hazard class A I and A II
- For the use of the drum pump in conjunction with drums
Unobstructed view the following adapters are necessary:
Adapter yellow (kind. 185708) for Free view 60 l barrel
Adapter Black (Art. 3569) for Free view 200 l drums

Scope Of Delivery

- Incl. mounting guide and screws



Title	PU Piece	Article No.
Plastic Barrel Pump	1	148966
Accessories Available		
ADAPTER FOR BURREL-PUMP	1	003116

INTERNAL/Approved (2019-03-23 00:15:16)

Portable device for washing parts

- Integrated sieve prevents coarse impurities of the cleaning liquid
- Easiest handling, everything packed in a case
- The cleaning brush is mounted on a flexible tube
- Integrated circulating pump for 230 V
- Easy draining of the cleaning liquid
- Easy stowable or transportable

Application Area

- For the fast and efficient cleaning of dirty or oily parts

Hints

- Do not use with pure gasoline or thinners. This can lead up to a defective pump



Title	PU Piece	Article No.
TRANSPORTABLE PARTS CLEANER	1	180978
AGR: 08.006		
Necessary Accessories	PU Canister	Article No.
SPECIAL CLEANER 5L	1	103156
Special Cleaner 30l	1	017410
Special Cleaner 60l	1	017464
Spare Parts	PU Piece	Article No.
CLEANING BRUSH PARTS WASHER	1	198661
FLUID PUMP PARTS CLEANER	1	198662

Parts Washing Device 7178

- Integrated air gun for drying
- Fluid transport only by pressure pads
- Externally located level indicator for control of the fluid level
- Separate discharge tap for removal of used cleaning fluid
- A closing plug at the vessel bottom provides the possibility to remove deposited dirt
- Transport quantity of the cleaner is adjustable via the integrated pressure reducer

Application Area

- Fast cleaning of detached or fixed parts directly on the vehicle, e.g. under the service lift

Characteristics

- 2 cleaning possibilities: Intensive cleaning with cleaner per washing brush or automatic cleaning via the rolling bath

Hints

- Optimally effective with the environmentally friendly Berner special cleaner
- Attention: Required amount of liquid: 50 l
- (also refer to the user manual)



Title	PU Piece	Article No.
Parts Washing Device 7178 - 65 l	1	219983

AGR: 08.006

Accessories Available	PU Canister	Article No.
Special Cleaner 30l	1	017410
Special Cleaner 60l	1	017464

Spare Parts	PU Piece	Article No.
SPARE TIRES KR 3202	1	006406
Brush Parts Washing D.	1	222798

INTERNAL/Approved (2019-03-23 00:15:37)

Spray

- With an 24-liter-A2-tank and a filling level indicator
- The helical distribution hose can be extenden up to a length of approx. 5m
- Mobile spray unit

Hints

- Warning: Not suitable for flammable or corroding liquids!

Technical Data

Working Pressure, Max. 8 bar

Title	Volume, Container	PU Piece	Article No.	
SPRUEHGERAET	22024/C5	24 l	1	880566

AGR: 08.007

Spare Parts

	PU Piece	Article No.
24801 JET FOR LANCE	1	039293
KR 2206 SPLASH LANCE COMPLINE	1	039294
CONNECTOR HOSE KR2205	1	039297



Spray INOX 24L

- With an 24-liter-A2-tank and a filling level indicator

Application Area

- For the safe atomization of detergents, lubricating oils and similar liquids with a low density

Hints

- Warning: This sprayer unit is suitable for all kinds of liquids, even for acidic products (with sulphuric acid, nitric acid, hydrochlorid acid), as long as the acidity is not exceeding 15-20% and the product does not tend to separate!

Technical Data

Working Pressure, Max. 8 bar

Title	Volume, Container	PU Piece	Article No.
23024 SPRUEHGERAET INOX 24L	24 l	1	150900

AGR: 08.007

Spare Parts	PU Piece	Article No.
24801 JET FOR LANCE	1	039293
KR 2206 SPLASH LANCE COMPLINE	1	039294
CONNECTOR HOSE KR2205	1	039297



Tyre Inflation Devices 2013/C5

- Certified tyre inflator with an automatic loading device
- With a certified manometer Ø 80 mm to read off

Technical Data

Manometer	Yes
Operating Pressure	7 bar
Operating Pressure, Max.	10 bar
Volume, Container	13 l
Temperature range	-20 - +60 °C

Title	PU Piece	Article No.
TIRE INFLATION DEVICE52013/C5	1	002314

AGR: 08.309

Accessories Available	PU Piece	Article No.
AUTOMATIC FILLING VALVE	1	400122
HANDLE W. FILL BELLE KR5201	1	039298



Manual Tyre Inflator PNEUREX

- Stable aluminium handle
- Rubber cap for the protection of the manometer
- Operating lever with a big lifting eye
- 50 cm filling hose with a lever plug nipple or a twin hold-on connector

Application Area

- Connection to the compressed air net

Characteristics

- Calibrated, overpressure safe
- Precision manometer Ø 80 mm
- (0–12 bar 0–170 psi)

Scope Of Delivery

- A DIN A4 calibration certificate is supplied with this tyre inflator

Technical Data

Manometer Yes

Title	PU Piece	Article No.
MANOSCOPE F. PNEUREX 0-12BAR	1	016555
MANUAL TYRE INFLATOR PNEUREX	1	146663
MANUAL TYRE INFLATOR PNEUREX 1	1	146664

AGR: 08.309



Calibrated Hand Tire Inflator

- Manometer with rubber jacket for protection against damage

Application Area

- Connection to the compressed air pipe

Technical Data

Manometer	Yes
Operating Pressure, Min.	0 bar
Operating Pressure, Max.	10 bar

Title	PU Piece	Article No.
Calibrated Hand Tire Inflator	1	161870

AGR: 08.309

Accessories Available	PU Piece	Article No.
CA 5121 Plug-In Nipple with External Thread 1/4	1	119377



Tyre Filler "WONDER"

Characteristics

- CE-certifier
- • Michelin licence production

Processing Information

- Not suitable for inflating or the checking of air pressure in tyres, which are filled with water

Technical Data

Manometer	Yes
Operating Pressure	15 bar

Title	PU Piece	Article No.
TYRE FILLER "WONDER"	1	929786

AGR: 08.309

Necessary Accessories	PU Amount	Article No.
CA 5121 Plug-In Nipple with External Thread 1/4	1	119377



Uncalibrated Hand Tire Inflator

- Manometer with rubber jacket for protection against damages

Application Area

- Connection to the compressed air pipe

Hints

- with mounted brass plug nipple G1/4" AG

Technical Data

Manometer	Yes
Operating Pressure, Min.	0 bar
Operating Pressure, Max.	10 bar



Title	PU Piece	Article No.
Uncalibrated Hand Tire Inflator	1	214264

AGR: 08.309

Accessories Available	PU Piece	Article No.
TYRE FILL VALVE	1	878973
CA 5121 Plug-In Nipple with External Thread 1/4	1	119377

5360-70 G Manometer MG

Application Area

- For portable tyre inflator and tyre inflation gun 5880

Characteristics

- Pressure gauge with Ø 80 mm
- Operating pressure from 0 to 10 bar

Title	PU Piece	Article No.
5360-70 G MANOMETER M. G.	1	400106

AGR: 08.309



Tyre Fill Valve With Handle

Title	PU Piece	Article No.
LEVER TYRE FILL VALVE	1	216376
TYRE FILL.VALVE	1	878973
TYRE FILL.VALVE W.HANDLE	1	824840

AGR: 08.309



Air Condition Service Unit KT 690 pro

Title	PU Piece	Article No.
CLIMATIC SERVICE EQUIPM.KT690	1	044670
AGR: 08.011		
Accessories Available	PU Piece	Article No.
Pumping oil for the service unit 0.6 liters	1	057498
Cartridge service unit from year of manufacture. 01/99 - 04/04	1	149939
PROT.SLEEVE FOR AIR CON	1	145056
PAPER FOR PRINTER AC	1	056213
FILTER DRIER FOR KC690 5117399	1	060592
BACK WHEEL 107027_01 AC	1	216032





Hose package 2 ND/HD

Application Area

- To extend the existing low-pressure / high-pressure connecting lines 2.4 m, especially in the commercial vehicle sector

Title	PU Piece	Article No.
EXTENSION SET FOR CLIMATSERV. AGR: 08.010	1	000239

Quick Coupling

Application Area

- Valves, which are connected to the climate system of the vehicle
- Suitable for KT 400/ KT 500/ KT 600/ KT 650/ KT 690 pro/ KT 790 pro

Title	PU Piece	Article No.
QUICK COUPLING HP (RED)	1	039943
QUICK COUPLING LP (BLUE)	1	039944

AGR: 08.010



Air conditioning service adapter HD

Title	PU Piece	Article No.
ACT12686 SERVICEADAPTER HD	1	180691

AGR: 08.010

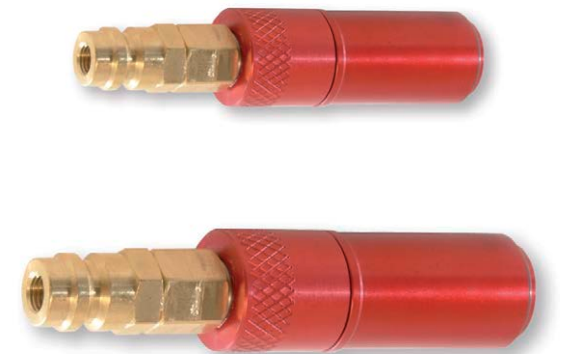

Compressor-Oil PAG

- Optimally matched to the respective air conditioning
- Protects the climate control system from corrosion and moisture
- Lubricate all moving parts
- Distributed evenly in the air circulation and ensures optimal return to the compressor

Application Area

- Synthetic polyalkylene glycol of (PAG) oil for lubrication of moving parts in the climate cycle of automotive air conditioning compressors

Hints

- The viscosities 46/100/150 are recommended to use by car-vehicle manufacturers
- PAG Oil with U / V is already buried contrast fluid, thus the contrast liquid can be taken preventively automatically for debugging in the climate cycle without a second container in the service unit to block the separate fluid contrast
- Do not mix with other viscosities



Title	Container	Content	Viscosity	PU Bottle	Article No.
Compressor Oil PAG 46	Can	250 ml	46	1/12	129308
Compressor Oil PAG 100	Can	250 ml	100	1/12	129298
Compressor Oil PAG 150	Can	250 ml	150	1/12	129299

AGR: 04.632

Hybrid Compressor Oil

- non-conductive
- Does not cause short circuits in case of leakages in air conditioning systems
- Stable lubricating oil film at high temperatures
- Good compatibility with the common seal materials cooling technology

Application Area

- Developed specifically for compressors in hybrid or electrical vehicles



Title	Container	Content	PU Can	Article No.
Hybrid air conditioning compressor oil	Can	250 ml	1/12	129302

AGR: 04.632

Injector gun with contrast fluid

- Very fast dosing of contrast fluid by means of an injector gun

Application Area

- For manual addition of contrast fluid on the cycle of the air conditioner

Processing Information

- Add approximately 6 ml contrastfluid with the aid of injector gun (1 raster) in to the cycle

Hints

- In particular at semi-automatic air-conditioning service required, where the contrast fluid is not automatically mixed (e.g mobile air-conditioners)

Scope Of Delivery

- injector gun with hose and coupling for R134a Service
- R12- Adapter
- 4 x 30 ml of contrast medium cartridges for every 5 applications



Title	PU Piece	Article No.
Injector gun with contrast fluid AGR: 08.010	1	157706
Spare Parts	PU Piece	Article No.
KONTRASTFLUID CARTRIDGE SET4PC	1	002110

UV leak detection case 12 V

Title	PU Piece	Article No.
UV-LEAK DET-CASE 12V CLIMATE AGR: 08.010	1	157709
Spare Parts	PU Piece	Article No.
UV-GLASSES CLIMATE-TEC	1	136268



KONTRASTFLUID CARTRIDGE SET4PC	1	002110
--------------------------------	---	--------



UV-leak detection lamp with glasses

- Easy to illuminate places which are hard to access because of the long and flexible cable
- Quick and visible locating of the leaking fluid due to triple UV LED lights
- Extremely high durability of the LED lamps

Application Area

- For finding leakages at the air-conditioning system

Scope Of Delivery

- 12V UV-lamp including a battery cable with clips and UV-safety glasses



Title	PU Piece	Article No.
UV-LEAK DET LAMP 12V W.GOGGLES	1	157707
Spare Parts		
UV-GLASSES CLIMATE-TEC	1	136268

INTERNAL/Approved (2019-03-23 00:17:38)

Contrast Fluid

- UV light causes the fluorescent Fluid to all leaks to glow
- Contrast fluid may remain for an indefinite period in the system
- Very good material compatibility, so rubber and O-rings will not be attacked
- Compatible with PAG, PAO and Erster oil

Application Area

- Check the air conditioning for any possible leaks

Hints

- Accessories to find the Leak detection equipment (UV light, glasses, etc.) in Chapter 16 Workshop Equipment / Air conditioning service.

Title	Container	Content	PU Bottle	Article No.
Contrast Fluid	Bottle	240 ml	1/12	129295

AGR: 04.630



Digital Thermometer

- Has a memory function to compare figures

Application Area

- Air temperature control at the air outlet of the air-conditioning system
- First diagnosis whether the air-conditioning system is working or not

Characteristics

- The display has a range from 50 to 150°C, a memory function enables the comparison of figures

Title	PU Piece	Article No.
DIGITALTHERMOMETER / RA 43240	1	011920

AGR: 08.309

Cock Key Uni Climate-Tec

- Universally applicable

Title	PU Piece	Article No.
VALVE SPANNER UNI CLIMATE-TEC	1	136278

AGR: 08.010



Multifunction Lithium Booster

- 3 in 1:
- Portable lithium booster
- Portable battery Charger
- Ultra Light torch led
- Equiped with electronic protection against reverse polarity and short circuit

Scope Of Delivery

- Multifunction lithium booster
- Power adaper
- Car charger
- For in one mobile phone adapter
- Storage battery wire clip



Technical Data

Length x width x height	165 x 75 x 30 mm
Peak Ampere	400 A

Title	Capacity	Weight	PU Piece	Article No.
Multifunction Lithium Booster	12 Ah	0.5 kg	1	239803

AGR: 08.003

Spare Parts

	PU Amount	Article No.
12V Start Cable Dir. M. Booster	1	244564

Charger For booster Pac/TMC Pac

Title	PU Piece	Article No.
CHARGER F. BOOSTER/TRUCK PAC	1	013104

AGR: 08.003



Lithium start booster 600A 12V

- Uses a high-capacity lithium battery with 18,000 mAh
- Fast charging and low self-discharge
- Up to 1,000 charging cycles
- Three lighting modes: standard, warning lights, SOS
- integrated safety functions

Application Area

- For emergency start vehicles 12 volts.

Processing Information

- Don't use more 5 secondes to start the vehicle.

Hints

- Important ! Never use the starting aid for more than 5 seconds. After 5 seconds, wait until the cables have cooled down.
- The power supply via the ODB II connector may only be carried out when all the loads on the vehicle are switched off. The connection may only be made when the control units are in "sleep mode" (can take up to 60 minutes depending on the manufacturer). Check the residual current before replacing the batteries. This must be below 10A.

Scope Of Delivery

- The ODB cable is not included in the scope of delivery and can be ordered as an accessory
- The ODB cable is used to maintain the voltage during a battery change

Technical Data

Length x width x height	230 x 28 x 85 mm
Peak Ampere	600 A

Title	Weight	PU Piece	Article No.
Lithium start booster 600 A	700 g	1	242639

AGR: 08.003



INTERNAL/Approved (2019-03-23 00:18:29)

Accessories Available

	PU Amount	Article No.
Battery cable mini booster lithium	1	244810
Cable Ipad 3X1	1	244811
Car Charger mini booster lithium	1	244812
Charger 220 volts mini booster lithium	1	244814
OBD CABLE BOOSTER LITHIUM 12 V	1	249735

Car Charger mini booster lithium



Title	PU Piece	Article No.
Car Charger mini booster lithium	1	244812

AGR: 08.003

Accessories Available

	PU Amount	Article No.
Lithium start booster 600 A	1	242639

16

OBD cable for booster lithium 12 Volts

Application Area

- To conserve memories during battery exchange.



Title	PU Piece	Article No.
OBD CABLE BOOSTER LITHIUM 12 V	1	249735

AGR: 08.003

Booster 12V STANDARD

- Protection from short circuits
 - ▶ Integrated circuit breaker
- On/Off switch for voltage and spark free connection
- Surge protection
- Allows to retain the data and codes in the vehicle by connecting the booster to the cigarette lighter (cable has to be ordered separately)
- Allows operation with 12V DC devices that have a cigarette lighter plug
- High power output
 - ▶ Straight HD clamps
- Long and super flexible cables
- Automatic battery charger (1 Amp) maintains the battery at full charge without damaging it
- DEKRA and CE approved



Application Area

- Starting or restarting a vehicle
- Power supply when replacing the vehicle battery

Hints

- First connect the positive (red) charging clamp to the positive pole clamp, then the negative (black) charging clamp to the mass of the vehicle or to the negative pole clamp (check the notes of the vehicle manufacturer).
- After use, immediately connect to the charging device. Please observe the notes in the operating instructions!

Technical Data

Length x width x height	310 x 90 x 280 mm
Peak Ampere	2200 A
Voltage	12 V
Cranking Amps	800 CA (12V)
Cable Length	1.2 m
Cable Cross Section	21 mm ²
Diesel - Max. Engine size	2.1 l
Gasoline - Max. Engine size	4.5 l
Max. Engine size HP	200 HP

INTERNAL/Approved (2019-03-23 00:18:57)

Title	Capacity	Weight	Cable Length	Voltage	PU Piece	Article No.
Booster 12V STANDARD	16 Ah	8.0 kg	1.2 m	12 V	1	369119

AGR: 08.003

Spare Parts

	PU Piece	Article No.
12V Cigarette Lighter Charging Cable	1	362977
Battery Clamp Black Straight	1	342917
Battery Clamp Red Straight	1	342918
Charger Booster 12V Standard	1	342919
Fuse 300A Booster	1/3	342921
Fuse Holder	1	342923

Booster 12V PREMIUM

- Short circuit protection by a circuit breaker
- On/Off switch for voltage and spark free connection
- Anti-surge protection
- Allows you to retain the data and codes in the vehicle by connecting the booster to the cigarette lighter
- Allows operation if 12V DC devices that have a cigarette lighter plug
- USB 2,1A output
- Digital Display for charge stage internal battery and voltage vehicle battery
- 45° curved HD clamps for high power output and a perfect handling
- Long and super flexible cables
- Automatic battery charger (1 Amp) maintain the battery at full charge without damaging it
- 2 Years warranty
- DEKRA and CE approved

Application Area

- Starting or restarting a vehicle
- Power supply when replacing the vehicle battery



Hints

- Firstly connect the positive (red) charging clamp to the positive pole clamp, than the negative (black) charging clamp to the mass of the vehicle or to the negative pole clamp, resp. observe the notes of the vehicle manufacturer. After use, immediately connect to the charging device.
- Please observe the notes in the operating instructions!

Technical Data

Length x width x height	310 x 130 x 340 mm
Peak Ampere	2200 A
Voltage	12 V
Cranking Amps	900 CA (12V)
Cable Length	1.45 m
Cable Cross Section	33.6 mm ²
Diesel - Max. Engine size	3.0 l
Gasoline - Max. Engine size	6.0 l
Max. Engine size HP	250 HP

Title	Capacity	Weight	Cable Length	Voltage	PU Piece	Article No.
Booster 12V PREMIUM	22 Ah	9.7 kg	1.45 m	12 V	1	338993

AGR: 08.003

Spare Parts

	PU Piece	Article No.
Fuse 300A Booster	1/3	342921
Fuse Holder	1	342923
Battery Booster 22Ah-12V 900CA	1	342915
Charger Booster 12/24V	1	342920
Battery Clamp Red 45° Curved	1	342924
Battery Clamp Black 45° Curved	1	342916
12V Cigarette Lighter Charging Cable	1	362977

Booster 12/24V UNIVERSAL

- Capacity: 2 x 16 Ah
- Short circuit protection by a circuit breaker
- On/Off (12V/0V/24V) switch for voltage and spark free connection
- Anti-surge protection
- Allows you to retain the data and codes in the vehicle by connecting the booster to the cigarette lighter
- Allows operation if 12V DC devices that have a cigarette lighter plug
- USB 2,1A output
- Digital Display for charge stage internal battery and voltage vehicle battery
- 45° curved HD clamps for high power output and a perfect handling
- Long and super flexible cables
- Automatic battery charger (1 Amp) maintain the battery at full charge without damaging it
- DEKRA and CE approved



Application Area

- Starting or restarting a vehicle
- Power supply when replacing the vehicle battery

Hints

- Firstly connect the positive (red) charging clamp to the positive pole clamp, than the negative (black) charging clamp to the mass of the vehicle or to the negative pole clamp, resp. observethe notes of the vehicle manufacturer. After use, immediately connect to the charging device.
- Please observe the notes in the operating instructions!

Technical Data

Length x width x height	370 x 215 x 370 mm
Peak Ampere	3200 A
Voltage	12 V 24 V
Cranking Amps	1320 CA (12V), 660 CA (24V)
Cable Length	1.45 m
Cable Cross Section	33.6 mm ²
Diesel - Max. Engine size	5.0 l
Gasoline - Max. Engine size	8.0 l

Max. Engine size HP 300HP (12V) / 450 HP (24V)

Title	Weight	Cable Length	Voltage	PU Piece	Article No.
Booster 12/24V UNIVERSAL	17.6 kg	1.45 m	12, 24 V	1	338992

AGR: 08.003

Spare Parts

	PU Piece	Article No.
Battery Clamp Black 45° Curved	1	342916
Battery Clamp Red 45° Curved	1	342924
Fuse 500A Booster	1/3	342922
Fuse Holder	1	342923
Battery Booster16Ah-12V	1	342914
Charger Booster 12/24V	1	342920

Trolley Booster 12/24V

- Powerful Booster to start diesel engine up to 260 KW (12V) and 370 KW (24V)
- High peak intensity of 4600 A (12V), 2300 A (24V)
- Capacity: 2x 22 Ah
- Voltage selection 12V or 24V via Anderson connector for a spark free connection
- Warning buzzer in case of reverse polarity
- Battery Gas Exhaust System for a safety work
- 12V Cigarette-lighter socket for memory saver application
- Short circuit protection for the booster by a circuit breaker (300A Fuse)
- Fully insulated 45° curved HD clamps for high power output and a perfect handling
- Very robust device due to rotomolded housing
- Save working due to a long, double insulated cable for reaching the poles on commercial vehicles and passenger cars
- Easy transport of the booster due to integrated wheels and a telescope handle for the outside using
- Possibility for Alternator testing with the integrated Voltmeter
- Can be left permanently connected to the fully automatic and intelligent charger, to maintain correct charge level



INTERNAL/Approved (2019-03-23 00:19:25)

Application Area

- Starting or restarting of 12V or 24V gasoline or diesel vehicles
Memory saving application

Hints

- Firstly connect the positive (red) charging clamp to the positive pole clamp, than the negative (black) charging clamp to the mass of the vehicle or to the negative pole clamp, resp. observe the notes of the vehicle manufacturer. After use, immediately connect to the charging device. Please observe the notes in the operating instructions!

Technical Data

Length x width x height	450 x 250 x 550 mm
Peak Ampere	4600 A
Voltage	12 V 24 V
Cranking Amps	1800 CA (12V), 900 CA (24V)
Cable Length	1.40 m
Cable Cross Section	35 mm ²
Diesel - Max. Engine size	7.0 l
Gasoline - Max. Engine size	10.0 l
Max. Engine size HP	350HP (12V) / 500 HP (24V)

Title	Weight	Cable Length	Voltage	PU Piece	Article No.
Trolley Booster 12/24V	25 kg	1.40 m	12, 24 V	1	339027

AGR: 08.003

Spare Parts

	PU Piece	Article No.
Battery Clamp Black 45° Curved	1	342916
Battery Clamp Red 45° Curved	1	342924
HANDLE F. TROLLEY BOOSTER	1	351694
Fuse 300A Booster	1/3	342921
6" PNEU.WHEEL F.TROLLEY BOOSTER	1	351693
Battery Booster 22Ah-12V 900CA	1	342915
CHARGER BOOSTER 12/24V TROLLEY	1	351695
Cigarette Lighter Cable for Trolley Booster	1	362976

INTERNAL/Approved (2019-03-23 00:19:29)

Trolley Booster 12/24V

- Powerful booster
 - ▶ To start diesel engines up to 260 KW (12V) and 370 KW (24V)
- High peak intensity
 - ▶ 4600 A (12V)
 - ▶ 2300 A (24V)
- Capacity: 2x 22 Ah
- Spark free connection
 - ▶ Voltage selection of 12V or 24V via Anderson connector
- Warning buzzer in case of reverse polarity
- Work safety
 - ▶ Battery gas exhaust system
 - ▶ Long, double insulated cable for reaching the poles on commercial vehicles and passenger cars
- 12V cigarette-lighter socket for memory saving application (cable has to be ordered separately)
- Short circuit protection
 - ▶ Integrated circuit breaker (300A fuse)
- High power output and perfect handling
 - ▶ Fully insulated 45° curved HD clamps
- Very robust device
 - ▶ Rotomolded housing
- Easy to transport
 - ▶ Integrated wheels and telescope handle for the outside use
- Alternator testing possible
 - ▶ Integrated voltmeter
- Can be left permanently connected to the fully automatic and intelligent charger, to maintain correct charge level



Application Area

- Starting or restarting of 12V or 24V gasoline or diesel vehicles
- Memory saving application

Hints

- First connect the positive (red) charging clamp to the positive pole clamp, then the negative (black) charging clamp to the mass of the vehicle or to the negative pole clamp (check the notes of the vehicle manufacturer).
- After use, immediately connect to the charging device. Please observe the notes in the operating instructions!

Technical Data

Length x width x height	450 x 250 x 550 mm
Peak Ampere	4600 A
Voltage	12 V
	24 V
Cranking Amps	1800 CA (12V), 900 CA (24V)
Cable Length	1.70 m
Cable Cross Section	50 mm ²
Diesel - Max. Engine size	7.0 l
Gasoline - Max. Engine size	10.0 l
Max. Engine size HP	350HP (12V) / 500HP (24V)

Title	Weight	Cable Length	Voltage	PU Piece	Article No.
Trolley Booster 12/24V	25 kg	1.70 m	12, 24 V	1	369120

AGR: 08.003

Spare Parts

	PU Piece	Article No.
Battery Clamp Black 45° Curved	1	342916
Battery Clamp Red 45° Curved	1	342924
HANDLE F. TROLLEY BOOSTER	1	351694
Fuse 300A Booster	1/3	342921
6" PNEU. WHEEL F. TROLLEY BOOSTER	1	351693
Battery Booster 22Ah-12V 900CA	1	342915
CHARGER BOOSTER 12/24V TROLLEY	1	351695
Cigarette Lighter Cable for Trolley Booster	1	362976

Hybrid Booster 12V-1200A

- Revolutionary ultra-capacitive technology: autonomous, maintenance-free, ultra-light, compact and powerful.
- Combination of ultra capacitor technology (instead of a traditional lead-acid battery) with an extra lithium battery.
- The ultra capacitors recharge in just a few minutes in 3 different ways.
 - ▶ Method 1: Connect the clamps to the battery of vehicle even if battery is low until 8V (1 to 2 min).
 - ▶ Method 2: via the cigarette lighter cable (supplied) plugged into the passenger compartment (2 to 4 min).
 - ▶ Method 3: via the built-in Lithium battery (4 to 6 min).



- Once the ultra capacitors are loaded via one of the 3 methods, the booster is ready to use.
- Maintenance free: This technology does not need to be constantly in charge. The booster can be left for long periods without load (no damage), it can be used at any time and under any circumstances.
- Protection against short circuits and against polarity inversions.
- Digital display of the charge level of the capacitors and battery voltage.
- Display of the charge level of the Lithium battery by 4 LEDs.
- Anti-shock rubber protection.
- "Override" mode: allows to start vehicles without battery.
- "Glow" mode: adapts to the preheating phase of diesel vehicles during start-up.

Application Area

- To start or restart unloaded vehicles.
- Starts diesel engines up to 4L and gasoline up to 6L capacity.

Scope Of Delivery

- Supplied with car charger (to charge the capacitors in the car) and a micro-USB charger (to charge the lithium battery backup).

Technical Data

Peak Ampere	2400 A
Voltage	12 V
Cranking Amps	1200 A (12V)
Cable Length	0.9 m
Cable Cross Section	13 mm ²
Diesel - Max. Engine size	4.0 l
Gasoline - Max. Engine size	6.0 l
Max. Engine size HP	300 HP

Title	Weight	Cable Length	Voltage	PU Piece	Article No.
Hybrid Booster 12V-1200A	2.8 kg	0.9 m	12 V	1	338991

AGR: 08.003

INTERNAL/Approved (2019-03-23 00:19:55)

Workshop tools

Spare Parts

	PU Amount	Article No.
Back-up Lithium Battery Hybrid	1	351701
Charger Micro USB with Cable Hybrid Booster	1	351697
Cigarette Lighter Cable Hybrid Booster	1	351700
Clamp for Hybrid Booster Black	1	351698
Clamp for Hybrid Booster Red	1	351699
Micro USB Charging Cable Hybrid Booster	1	351696

Battery charger solar 12 volts-4 Watts

- No main power or wiring requires only daylight to work, charges even if the weather is overcast or dull.

Application Area

- To charge 12 Volts lead-acid batteries with no additional running coast.

Characteristics

- Operating voltage: 12V
- power output: 4 W

Scope Of Delivery

- On board diagnostic (OBD) II plug, 12 Volts DC plug, alligator battery clamps, extension wire and suction cups.

Title	PU Piece	Article No.
Battery charger solar 12 volts-4 Watts	1	335131

AGR: 08.003



Old Oil Collecting Device 42085

- Fast and simple discharging via compressed air connection
- Filling level can be read on the external viewing tube
- Collecting pan with a diameter of 43.4 cm has a sieve insert, closing valve and is turnable and height adjustable
- Sieve insert serves as filter and at the same time for the dripping off of the unmounted filters

Technical Data

Suction Volume	85 l
Suction Output	65 m ³ /h
Volume Of The Collection Basin	17 l
Length, Drain Hose	2 m
Discharge Pressure	0.5 bar



Title	Container-Ø	Empty Weight, Kg	Total Height	PU Piece	Article No.
Old Oil Coll. Device 42085	42 cm	33 kg	1660 mm	1	043954

AGR: 08.006

Spare Parts

	PU Piece	Article No.
SPARE TIRES KR 3202	1	006406

Equipment for the collection of waste oil, plastic

- Light and easy waste oil collection device: Height-adjustable collecting funnel due to telescopic tube
- Grid in the collecting funnel for the filtering of gross impurities and for the complete emptying of oil filters
- Special extension hopper
- Fill level indicator
- Due to the plastic construction scratches through contact with the vehicle are avoided
- Drain tap for draining

Application Area

- For the collection of waste oil

Technical Data

Suction Volume	30 l
Volume Of The Collection Basin	10 l



Title	Container-Ø	Empty Weight, Kg	Total Height	PU Piece	Article No.
OIL DRAINER KU, 30L	32.5 cm	8.9 kg	1100 mm	1	180977

AGR: 08.006

INTERNAL/Approved (2019-03-23 00:20:25)

Waste oil aspirator 43024

- With fill level indicator

Characteristics

- Suction capacity after the vacuum generation 13-16 liter
- Amount of suction at an oil temperature of 70/80°C and a probe with a diameter of 6 mm: 1.5 - 2 liter/min,
- Length of the suction hose: 2 m,
- Manual emptying of the suction device

Hints

- Attention: Brake oil, fuels or other inflammable liquids or corrosive liquids should under no circumstances be sucked off!

Technical Data

Suction Volume	16 l
Length, Suction Hose	2 m



Title	PU Piece	Article No.
ALTOELABSAUGGERAET 43024/C5	1	150901
AGR: 08.006		
Scope Of Supply		Piece Article No.
SENSOR 7X1000 FLEX. 45517	1	075853
SENSOR 8X700 FLEX. 45518	1	075854
SENSOR 6X700 FLEX. 45506	1	075852
SENSOR 5X700 FLEX. 45504	1	075851

Oil Vacuum and Oil Collecting Device 44085

- Fast and easy tank discharge via compressed air connection
- Fill level can be read on the external viewing
- Transparent suction head/screen glass with 8 l volume for control
- Collecting bowl with a diameter of 43.4cm has sieve insert, stop cock and it is turnable and height adjustable
- Sieve insert functions as a filter and at the same time for dripping off of the dismantled filter

Processing Information

- For generation of negative pressure there is a timeframe of 2.5 - 3 min
- the noise exposure is 75 dB

Scope Of Delivery

- Incl. 6 different probes Ø 5 – 8 mm, length 70 – 100 cm and 3 adapters (Volkswagen, BMW, Citroën)

Technical Data

Suction Volume	80 l
Suction Output	62 m ³ /h
Suction Speed	1.5 l/min
Volume Of The Collection Basin	16 l
Length, Drain Hose	2 m
Length, Suction Hose	2 m
Discharge Pressure	0.5 bar



Title	Container-Ø	Empty Weight, Kg	Total Height	PU Piece	Article No.
Oil Collecting and Gathering Device 44085	42 cm	41 kg	1660 mm	1	043689
Spare Parts				PU Piece	Article No.
SPARE TIRES KR 3202				1	006406

INTERNAL/Approved (2019-03-23 00:20:41)

Truck oil suction and collecting device 46215

Characteristics

- Movable 115-liter collecting tank,
- Collecting tray with a capacity of 50 liter,
- Tank volume 65 liter,
- Suction capacity after the vacuum generation 75-80 liter
- Suction quantity at an oil temperature of 70/80°C and a probe with a diameter of 6 mm: 1.5 - 2 liter/min

Processing Information

- Necessary oil temperature 70/80 °C
- The transfilling into the collective tank may only take place after the suction

Hints

- Not suitable for brake oils, fuels, inflammable or corrosive fluids of all kind!
- Due to stock variations supplied in blue or green

Technical Data

Suction Volume 115 l



Title	PU Piece	Article No.
ABSAUG-U.SAMMELGERAET 46215/C5	1	929000*

* = The delivery time is 56 days

AGR: 08.006

Scope Of Supply

	Amount	Article No.
SENSOR 5X700 FLEX. 45504	1	075851
SENSOR 6X700 FLEX. 45506	1	075852
SENSOR 7X1000 FLEX. 45517	1	075853
SENSOR 8X700 FLEX. 45518	1	075854

Oil Fill Device

- 24-liter-tank and filling indicator

Processing Information

- maximal pressure for safety valve is 10bar
- Oil production is done by 0.2 per pump double stroke

Hints

- Not suitable for inflammable or corrosive fluids!
- Due to stock variations supplied in blue or green

Technical Data

Operating Pressure, Max.	8 bar
--------------------------	-------

Title	Length, Suction Hose	Suction Volume	PU Piece	Article No.
OELFUELLGERAET 32024/C5	2 m	24 l	1	121156

AGR: 08.007



Gear Box Fluid Filler 10L

- Tank with 10 liter capacity and scale for reading the capacity
- Hose length 2.00 m
- Ball valve with connection coupling for special adapter to provide leakage protection
- High quality, robust pump with aluminum body
- Quick coupling for filling hose for easy change of adapters
- Included hook adapter for universal use
- With the supplied screw adapters running back the amount of overflow is possible



Workshop tools

- Made in Germany

Application Area

- For fast and clean direct filling of manual transmissions, differentials and transfer cases
- Pleasant and easy filling from the bottom when the vehicle is on the lift
- Suitable for VAG DSG automatic transmission such as and CVT transmission

Hints

- Not suitable for fuels and solvents
- To avoid mixing different types of gear oil, the pump, the tank and the filler hose must be cleaned thoroughly after use

Scope Of Delivery

- double action
- Canister 10 l
- Three screw adapter and two adapters with hook
- The included adapters are suitable for Audi, Seat, Skoda, VW



Title	PU Piece	Article No.
GEARBOX FLUID FILLER 10L AGR: 08.007	1	157260

Fuel suction apparatus 180-220 kg

- The air-compressed fuel suction device is mounted on a driving carriage and can take up barrels of 180 - 220 kg
- Due to the special VITON sealing gasoline or diesel can be sucked off with this device
- The device is protected against static discharge with the help of a grounding cable

Processing Information

- Max. air consumption: 130 l/min
- Max. temperature sucked in liquid: 40 ° C

Hints

- The pump has an Atex marking EX II 3 c 100 °C. This means that it can be also used in areas with a potentially explosive atmosphere, provided that this areas are classified according to guideline 99/92/ EG ATEX 137 as a zone 2 and that the atmosphere is not inflammable due to surface temperaturer under 100 °C.
- The pump must not be used in areas where the atmosphere potentially includes explosive dust.

Scope Of Delivery

- 2 m suction hose and filling hose
- Flexible probe diameter 8 and 12 mm
- Adapter for 6 - 8 - 10 mm pipelines



Title	PU Piece	Article No.
45280 FUELSUCT.DEVICE W.TROLLY	1	042697

AGR: 08.006

ADBLUE® Hand Pump

- Use for AdBlue® and all non-aggressive median
- Suitable for 60l and 200l barrel
- Exact positioning on the container by use of counter-screw connection
- 2m removable transparent filling hose

Application Area

- For manual AdBlue® filling from canisters and drums



Adapter G2" I-M56x4a
(Accessory)

Title	PU Piece	Article No.
ADBLUE® Hand Pump with hose	1	341067

AGR: 08.007

PU Amount	Article No.
1	344099

Waste oil receiving Pan 8L

- Universal collecting tray for diverse liquids
- 8 l capacity
- Practical spout for clean discharging
- Appliance for draining of oil filters

Application Area

- Collecting tray for diverse liquids with drain appliance for oil filters



Title	Length	Width	Height	Volume	PU Piece	Article No.
Waste oil receiving Pan 8L	430 mm	400 mm	110 mm	8 l	1	219209

AGR: 08.006

INTERNAL/Approved (2019-03-23 00:21:17)

Catch Bassin Open P 45

- Overflow edge, which is extra broadly designed at the front and back area, prevents spilling
- Problem-free transfilling due to a pour out feature
- The outlet spout is equipped with a nonreturn valve at the inside, for preventing unintentional escape of liquids



Title	Length	Width	Height	Weight	Volume	PU Piece	Article No.
DRIP TRAY OPEN P 45	575 mm	465 mm	162 mm	1.3 kg	16 l	1	911801

AGR: 08.006

Collection bath large plastic

- Large volume
- Pouring aid
- Bigger collecting area
- Non-slip edge

Application Area

- For the collecting of liquids, as e. g. oils or cooling water



Title	Length	Width	Height	Weight	Volume	PU Piece	Article No.
OIL DRAIN BOWL BIG	820 mm	540 mm	200 mm	1.8 kg	24 l	1	180976

AGR: 08.006

Low profile fluid receive tank 20 L

- Specially built to absorb liquids
- Very flat, only 125 mm high. Fits under almost any car
- Large collecting surface, especially suitable for coolants
- Large sieve in the middle prevents splashing of liquids
- 4 guide rollers for easy maneuvering under the vehicle
- With venting screw for fast and clean discharging
- Highly robust
- Clean working

Application Area

- Clean collecting of liquids

Title	PU Piece	Article No.
Low profile fluid receive tank 20 L	1	219211

AGR: 08.006

Oil Catch Bassin 65L

Application Area

- Serves as a collector of engine oil, gear oil and differential oil of all vehicles that are located over a hole during the oil change

Characteristics

- The catch basin is equipped with a flood grid and a reflow grid, adjustable mount and basin, capacity of the basin 65 liter, width of the mount can be adjusted for holes from 750 mm up to 1200 mm

Hints

- Warning: No collection of inflammable or corrosion-promoting liquids!



Title	Weight	Volume	PU Piece	Article No.
OELAUFFANGWANNE 65L 42060	27.1 kg	65 l	1	150903

AGR: 08.006

Truck Wheel Pan Set 2 pcs

- For clean dismanteling of the drive shaft of trucks
- Trough roundings, suitable for various rim diameters
- Packed to 2 pc. Therefore work on both sides is possible
- Pour out feature for clean draining
- Oil and gasoline resistant
- Practical carrying handles
- Inward lying edges for avoiding a spill out of the liquid while carrying

Application Area

- For the collection of oil and other liquids

Scope Of Delivery

- 2 pc. Axial oil pan



Title	Length	Width	Height	Weight	Volume	PU Set	Article No.
TRUCK WHEEL PAN, 2 PC- 3L AGR: 08.006	246 mm	316 mm	156 mm	0.416 kg	3 l	1	198665

Coolant Catch Bassin 55L

- Especially dimensionally stable due to the 4-chamber system
- Safe transport and pour out through the 4 spout edges, no slop over
- Handy and particularly flat, fits under every car

Application Area

- Suitable for the collection of cooling water, engine oil, gear oil and other liquids



Title	Length	Width	Height	Volume	PU Piece	Article No.
COOLANT-DRIP TRAY 55L AGR: 08.006	1000 mm	725 mm	110 mm	55 l	1	137988

Cooling Water – Collection Tray

- Avoids pollution of soil and water by possible leaks of polluting liquids.
- Lightweight, mobile.
- Easily transportable.
- Side handle.

Application Area

- Construction site: Retention tray for chemicals products in cans or bottles.
Auto: Bin for the recovery of polluting liquids.
- Collection of cooling water and waste oil.

Characteristics

- Smooth, wear-resistant surface, chemical and heat resistant, shatterproof plastic, flat design suitable for lowered vehicles



Title	Length	Width	Height	Weight	Volume	PU Piece	Article No.
Cooling Water – Collection Tray	650 mm	450 mm	120 mm	1.9 kg	28 l	1	147322

AGR: 08.006

Car Jack ALU, 1,35 T

- This ultralight car jack is equipped with a rubber cover and nylon wheels
- The rubber pad covers the lifting point to 100 %, as some vehicle manufacturers prescribe
- Due to the Profi Joint-Drain Valve it is possible to lower the loaded car jack precisely and without any risk
- The Pumping piston is set in an angle of 45°, therefore the full stroke of the pumping piston can be used
- Extremely low weight and very handy

Application Area

- Lifting of vehicles



Title	Height	Height, Min.	Height, Max.	Width (B)	Bearing Load, Max.	Weight	Mobile	PU Piece	Article No.
Car Jack ALU, 1,35 T	1095 mm	80 mm	380 mm	236 mm	1350 kg	10 kg	Yes	1	217642

AGR: 08.002

Car Jack 2 T Low



Title	PU Piece	Article No.
Car Jack 2 T Low	1	352163

AGR: 08.002

Car Jack HD, 2T

- Very stable steel frame construction
- Flat car jack, min. height 85 mm
- Quick lift pedal, for reaching the position point comfortable and quick
- The rubber pad covers the lifting point to 100 %, as the german vehicle manufacturers prescribe
- Dead man's control, automatic stop, no uncontrolles lowering possible
- Highly robust, quiet nylon wheels
- Relatively compact and therefore good applicable at narrow spaces
- Precise lowering under load



Application Area

- Lifting of vehicles

Title	Height	Height, Min.	Height, Max.	Width (B)	Bearing Load, Max.	Weight	PU Piece	Article No.
Car Jack HD, 2T	1050 mm	85 mm	490 mm	370 mm	2000 kg	36.5 kg	1	218796

AGR: 08.002

Spare Parts

	PU Amount	Article No.
Rubberpad car jack 217639 & 218796	1	362972

Car Jack HD, 2 T Tandem

- Very stable steel frame construction
- Flat car jack, min. height 85 mm
- Quick lift pedal, for reaching the position point comfortable and quick
- The rubber pad covers the lifting point to 100 %, as some vehicle manufacturers prescribe
- Dead man's control, automatic stop, no uncontrolles lowering possible



- Highly robust, quiet nylon wheels
- Relatively compact and therefore good applicable at narrow spaces
- Precise lowering under load
- The tandem wheel ensure an easy and secure manoeuvre even on uneven grounds

Application Area

- Lifting of vehicles



Title	Height	Height, Min.	Height, Max.	Width (B)	Bearing Load, Max.	Weight	PU Piece	Article No.
Car Jack HD, 2 T Tandem	1050 mm	85 mm	490 mm	370 mm	2000 kg	37.2 kg	1	217639

AGR: 08.002

Spare Parts

	PU Amount	Article No.
Rubberpad car jack 217639 & 218796	1	362972

Car Jack HD, 2T High



Title	Height, Min.	Height, Max.	Bearing Load, Max.	Footprint (L)	Footprint (B)	Weight	Mobile	PU Piece	Article No.
Car Jack HD, 2T High	138 mm	800 mm	2000 kg	1310 mm	395 mm	58 kg	Yes	1	217641

AGR: 08.002

INTERNAL/Approved (2019-03-23 00:22:21)

Car Jack HD, 3T Turbo

- Very stable steel frame construction
- car jack with a Turbo-Lifter-System
- The rubber pad covers the lifting point to 100 %, as some german vehicle manufacturers prescribe
- Impact protection on the lowering valve
- The pump units are protected against dirt with a sleeve
- Heavy design for daily use
- Ideal for the lifting of SUV and light trucks
- Solide steel wheels
- Precise lowering of the load

Application Area

- Lifting of vehicles



Title	Height	Height, Min.	Height, Max.	Width (B)	Bearing Load, Max.	Weight	PU Piece	Article No.
Car Jack HD, 3T Turbo	1430 mm	135 mm	490 mm	380 mm	3000 kg	41 kg	1	217640

AGR: 08.002

Spare Parts

Rubberpad car jack 217640

PU Amount	Article No.
1	362973

16

1120/E lifiting jack

- Can be moved on floors with grates and is suitable during break-down service
 - ▶ Double frontal balancing rolls and rear turning wheels
- Low rolling resistance
 - ▶ Rolls made of polyurethan



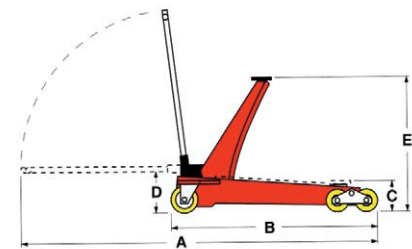

Title	Height, Min.	Height, Max.	Width (B)	Bearing Load, Max.	Footprint (L)	Footprint (B)	Weight	PU Piece	Article No.
1120/E lifting jack	130 mm	760 mm	530 mm	2000 kg	1030 mm	480 mm	65 kg	1	150868

AGR: 08.002

262 Trolley Jack

- Extraordinarily stable and user-friendly
- Equipped with a safety valve against overloading
- Detachable pull rod, for facilitating the transport process

Characteristics

- Manuell lowering of the lift truck trough turning of the pull rod



INTERNAL/Approved (2019-03-23 00:22:45)

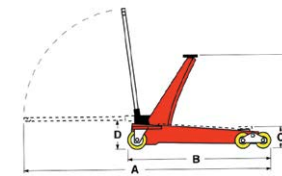
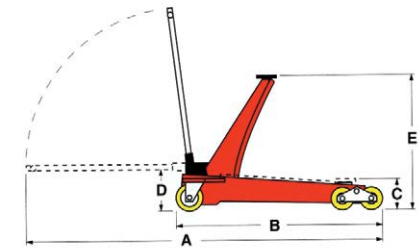

16

Title	Height, Min.	Height, Max.	Bearing Load, Max.	Footprint (L)	Footprint (B)	Weight	PU Piece	Article No.
Hydraulic trolley jack	145 mm	540 mm	4000 kg	1485 mm	370 mm	83	1	874340
Hydraulic trolley jack	185 mm	635 mm	10000 kg	1880 mm	445 mm	148 kg	1	874357

AGR: 08.002

Spare Parts

	PU Piece	Article No.
STEERING WHEEL F.LIFTER 1,5T	1	039296

INTERNAL/Approved (2019-03-23 00:22:49)

Oleopneumatic lift

- Practical and handy oil-pneumatic lifter for trucs and heavy-duty transport
- Pneumatic support during lifting
- Automatic retracion of the pistons
- Both lowering valves guarantee a perfectly controlled lifting and lowering speed under load
- Due to the different adapter a fast reach of the work height is ensured
- Adjustable transport and control lever
- Big tyres

Application Area

- Ideal for repair workshops, mobile workshops, tyre retailer and bodywork sector

Scope Of Delivery

- 3 piece adapter: 10 mm, 70 mm, 120 mm

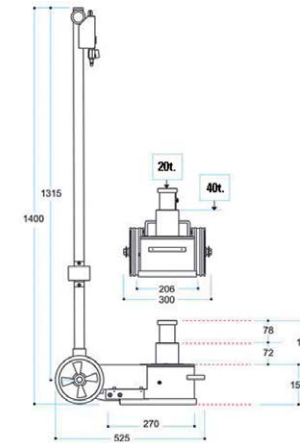

Title	Height, Min.	Height, Max.	Length	Bearing Load, Max.	Bearing Load, Min.	Footprint (L)	Footprint (B)	Weight	PU Piece	Article No.
Air hydraulic jack	150 mm	300 mm	525 mm	40000 kg	20000 kg	525 mm	300 mm	39 kg	1	151334

AGR: 08.002

Spare Parts

	PU Piece	Article No.
Extension for Jack 10 mm	1	143437
Extension for Jack 70 mm	1	143483
Extension for Jack 120 mm	1	143438

INTERNAL/Approved (2019-03-23 00:23:04)

Bottle Jack

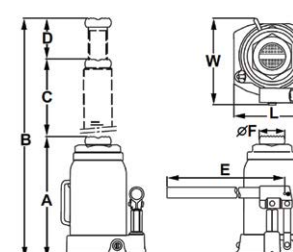
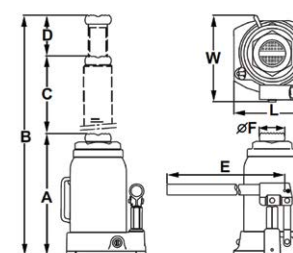

16

Title	Height, Min.	Height, Max.	Bearing Load, Max.	Footprint (L)	Footprint (B)	Weight	Mobile	PU Piece	Article No.
BOTTLE JACK 12T	240 mm	473 mm	12000 kg	134 mm	134 mm	7.9 kg	No	1	099871
BOTTLE JACK 20 TON	-	-	20000 kg	-	-	-	-	1	152828

AGR: 08.020

Tyre smart cart HD

- Enables the easy and ergonomical transport of wheels in the workshop
- The patented gripper system is unique, because the gripper arms adjust themselves and adapt to a tyre size of 14 to 20 Zoll
- Patentated tilting system ensures a shift of the axis during the tilting. Therefore a complete wheel set is effortless grabable
- The yellow solid rubber tyres are extremely durable and prevent bands on the floor
- Back-friendly tyre transportation



INTERNAL/Approved (2019-03-23 00:23:10)

Application Area

- Easy grabbing and transportation of several tyres simultaneously

Characteristics

- For tyre sizes: 14" - 20"
- With attachment for up to 8 tyres



Title	Bearing Load, Max.	Weight	PU Piece	Article No.
Tyre smart cart HD	200 kg	20.5 kg	1	218786

AGR: 08.199

Accessories Available

	PU Piece	Article No.
ACCESS. TYRE SMART CART HD	1	218787

Related Products

	PU Amount	Article No.
Tyre Smart Disc 500	1	366712

Truck heel heaver, small

- Practical work facilitation during the change of big tyres as of trucks or construction machiners
- Adjustable for different wheel sizes
- Rolls on the wheel fixture for an easy and quick positioning
- Rubberized and stabil handle for a secure hold and transportation
- Fixture adjustable in 3 positions

Characteristics

- For tyres: 6.5" - 22.5"
- Pos. 1 wide wheel fixture: 290 mm
- Pos. 2 wide wheel fixture: 450mm
- Pos. 3 wide wheel fixture: 620 mm



Title	Bearing Load, Max.	Weight	Mobile	PU Piece	Article No.
TRUCK WHEEL DOLLEY MAX 250KG	250 kg	14.5 kg	Yes	1	185000

AGR: 08.040

INTERNAL/Approved (2019-03-23 00:23:13)

CV Wheel Jack

- Especially suited for the fast centering of wheel studs during the assembly

Application Area

- For the assembly and disassembly as well as the transportation of truck tyres

Hints

- Indispensable tool in the case of a tyre damage





Title	Height	Bearing Load, Max.	Mobile	PU Piece	Article No.
388/B GOODS VEH WHEEL JACK	150 mm	500 kg	Yes	1	155016*

* = The delivery time is 35 days
AGR: 08.040

Tyre Smart Disc 500

- Tire Disc with 160 kg capacity and 500 mm Ø brings more mobility to the workshop and around the vehicle.
- Tyres Disc 500 and Smart Cart work perfectly together.
- The Smart Cart picks up the disc on the ground.
- Disc 500 tyres can be stacked

Application Area

- Easy transport of several tires thanks to the Tyre Disc 500



16

Title	PU Piece	Article No.
160	1	366712
Related Products	PU Amount	Article No.
Tyre smart cart HD	1	218786

INTERNAL/Approved (2019-03-23 00:23:34)

Support Frame Pair

- 3-legs, therefore an always secure stand and no tilting
- Solid steel frame
- 3 and 6 ton with a rubber overlay

Hints

- Attention: Always use the support frame in pairs, on a hard even surface
- The load must be centred on the carrying plate!



Title	Height, Min.	Height, Max.	Bearing Load, Max.	Footprint (L)	Footprint (B)	Weight	Mobile	PU Piece	Article No.
JACK STAND 6T	365 mm	565 mm	6000 kg	311 mm	311 mm	11.2 kg	No	1	106786
JACK STAND 12T	485 mm	750 mm	12000 kg	366 mm	366 mm	23.5 kg	No	1	104578
JACK STAND 20T	568 mm	923 mm	20000 kg	462 mm	462 mm	36 kg	No	1	152542

AGR: 08.009

151 Support Frame/PCS.





Title	Height, Min.	Height, Max.	Bearing Load, Max.	PU Piece	Article No.
151 UNTERSTELLBOCK/STK.	1030 mm	1720 mm	1000 kg	1	157355
215 UNTERSTELLBOCK/STK.	470 mm	680 mm	15000 kg	1	157356

AGR: 08.009

INTERNAL/Approved (2019-03-23 00:23:50)

388C Tow Car

Application Area

- For the lifting of vehicles for the use on tow trucks

Characteristics

- Load capacity 500 kg



16

Title	Bearing Load, Max.	Mobile	PU Piece	Article No.
388C TOWING TRCK	500 kg	Yes	1	123159*

* = The delivery time is 35 days
 AGR: 08.020

INTERNAL/Approved (2019-03-23 00:23:58)

Hydraulic Car taxi 19"

- Raises vehicles by means of a hydraulic foot pedals gently
- Castors allow maneuvering of vehicles on solid ground and in tight spaces
- Support rollers made of plastic
- When using 2 x 180 ° maneuvering, at 4 x maneuvering 360 ° rotation possible
- Suitable for tires up to a width of about 300 mm
- Raise Hardmount foot pedal for convenient and reduce the maneuvering
- The four ball bearing solid rubber swivel castors of maneuvering are on hinges with self-lubricating Mounted ball bearings
- PVC protection requirements for tires, lift gently rank and lower
- Safety pins reliably prevent unwanted Lowering the wheel.

Application Area

- To vehicles, without starting the engine, maneuvering to be able. Whether in the workshop, painting booth, exhibition halls, towing companies or even parking garages
- Very suitable in body shops where the vehicle no longer roadworthy or the engine has been removed
- For space-saving storage of vehicles in repair breaks

Characteristics

- Number of castors: 4 pc's
- Art of roles: Rubberized
- For wheel diameters up to: 650 mm max. 19"
- Tyre size: 13 "- 19"

Hints

- The respective maneuvering laterally under the wheel pushed. The foot pedal is then the car pumped up until the wheel in question is freely suspended

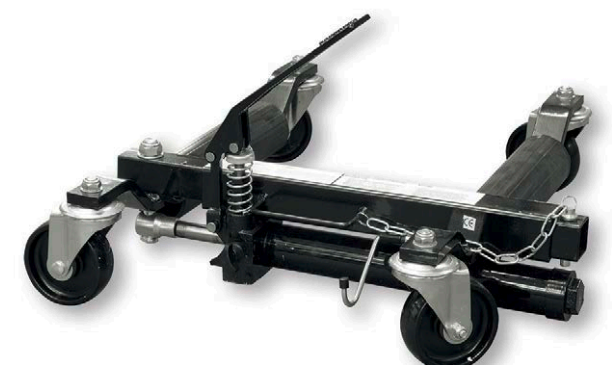

Workshop tools

Title	Height	Height, Min.	Width (B)	Bearing Load, Max.	Bearing Load, Min.	Weight	Mobile	PU Piece	Article No.
Hydraulic Car taxi 19"	220 mm	220 mm	560 mm	2400 kg	600 kg	19 kg	Yes	1	245729

AGR: 08.002

Slalom Cart 388/A



Title	PU Piece	Article No.
SLALOM CART 388/A	1	244200

AGR: 08.020

Mounting Nose



Title	PU Piece	Article No.
GUARD FOR CLAMPING JAW VENUS	1	017925
MOUNTING NOSE	1	017923
RIM SPARE JAW LONG VERSION	1	017924
RIM SPARE JAW SHORT VERSION	1	017926

AGR: 08.040

Equipment for Tyre changer BTC 23" and BTC 29"

Title	PU Piece	Article No.
Bead breaker protector	1	092590
Jaws protection Kit BTC 23"	1	092583
JAWS PROTECTION KIT BTC 29"	1	092585
Mounting Head Protector	1	092586
Mounting Head Protector	1	092587

AGR: 08.040

INTERNAL/Approved (2019-03-23 00:24:18)

Inflator Gun "Bead Bazooka" 6L

Title	PU Piece	Article No.
Inflator Gun "Bead Bazooka" 6L AGR: 08.040	1	218788



Motor cycle free jack 562

Application Area

- Height-adjustable support trestle for lifting the rear wheel

Title	PU Piece	Article No.
562 MOTOR CYCLE LIFT CLEAR AGR: 08.009	1	150243



Workshop Press Combi

Title	PU Piece	Article No.
GARAGE PRESS 20T COMBI USE AGR: 08.000	1	136592

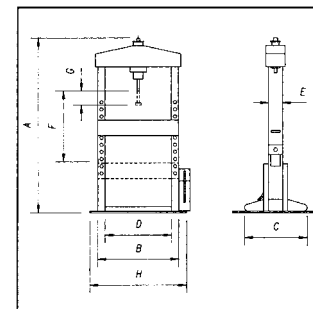
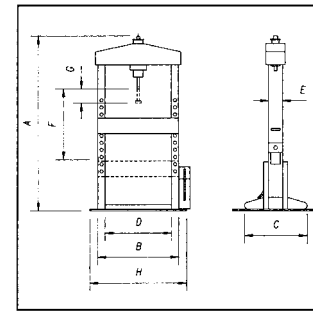

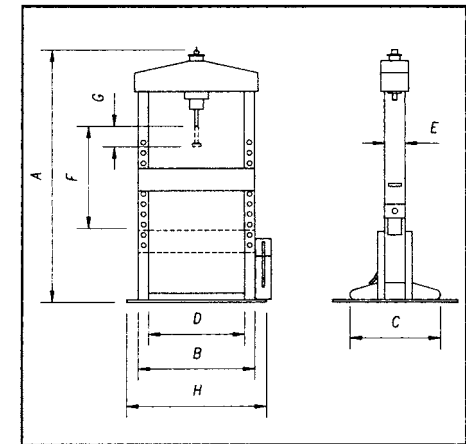

Workshop Press

Title	Pressure Force, Max	PU Piece	Article No.
WORKSHOP PRESS 50 T AGR: 08.000	50 kN	1	121422

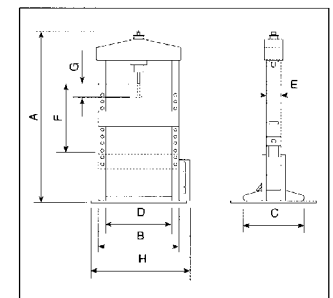

INTERNAL/Approved (2019-03-23 00:24:45)

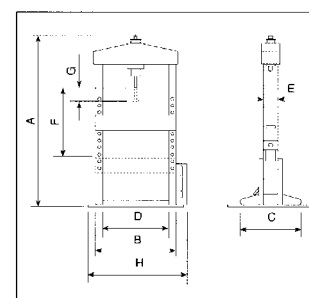
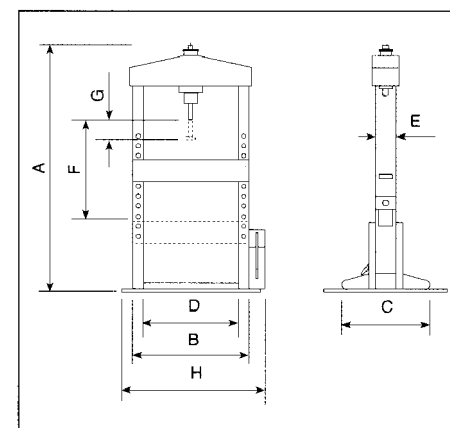
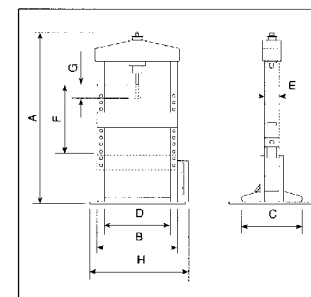

Prism Plate Slim

Title	PU Piece	Article No.
PRISM PLATE SLIM AGR: 08.000	1	019808



Universal Compression Set for press

Title	PU Piece	Article No.
SPRING CATCH SET F.PRESS AGR: 03.419	1	014088



Workshop Cranes 8276/8277

- Load hook lock for safe transport of pieces in the workshop
- Less need for stand surface and mobility in the workshop foldable carriage
- Secure positioning, e.g. during engine installation, by opening the hand wheel a release to any desired height is achieved
- Wide carriage for load stability at highest load

Characteristics

- High bearing capacity up to 500kg resp. 1000 kg



Technical Data	8276
Dimension when folded (W x H x D):	1560 x 400 x 380 mm
Length of chassis:	1570 mm
Chassis (outer/inner):	900/780 mm
Discharge:	1000 - 1300 mm
Bearing capacity (depending on discharge):	150 - 500 kg
Height max.:	2360 mm
Height min.:	400 mm
Weight:	80 kg

Title	Height	Height, Min.	Height, Max.	Width (B)	Bearing Load, Max.	Extension, Min. Or Single Value	Extension (Max.)	Footprint (L)	Footprint (B)	Weight
Workshop Crane 8276	1560 mm	400 mm	2360 mm	400 mm	500 kg	1000 mm	1300 mm	900 mm	780 mm	72 kg

Mobile	PU Piece	Article No.
Yes	1	558796

AGR: 08.001

Gear Box Lifter 300 and 600 kg

- Big ball bearing mounted tyres and therefore easy to roll
- Made in Italy



Title	Height, Min.	Height, Max.	Bearing Load, Max.	Footprint (L)	Footprint (B)	Weight	Mobile	PU Piece	Article No.
GEAR BOX LIFTER 300 KG	1120 mm	1970 mm	300 kg	450 mm	450 mm	27 kg	Yes	1	198185
GEAR BOX LIFTER 600 KG	1140 mm	1990 mm	600 kg	550 mm	600 mm	29 kg	Yes	1	198184

AGR: 08.001

Spare Parts

	PU Amount	Article No.
Wheel Transmission Jack 198184	1	358528
Wheel Transmission Jack 198185	1	358531

INTERNAL/Approved (2019-03-23 00:25:13)

Gear Box Lifter 800kg, Tandem

- Two-step pump
- Two-step piston
- Big ball bearing mounted tyres and therefore easy to roll
- Secure stand space
- Slow lowering of the load on the handwheel possible
- Made in Italy



16

Title	Height, Min.	Height, Max.	Bearing Load, Max.	Footprint (L)	Footprint (B)	Weight	Mobile	PU Piece	Article No.
GEAR BOX LIFTER 800 KG, TANDEM	850 mm	1870 mm	800 kg	580 mm	580 mm	49 kg	Yes	1	198183

AGR: 08.001

Spare Parts

	PU Amount	Article No.
Wheel Transmission Jack 198183	1	358527

15/73 Top For Transmission Jack



INTERNAL/Approved (2019-03-23 00:25:26)

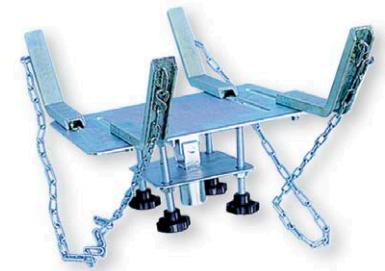

Title	Bearing Load, Max.	PU Piece	Article No.
15/73 TOP F. GEARBOX HOIST AGR: 08.001	600 kg	1	150875

111 Engine Lifter

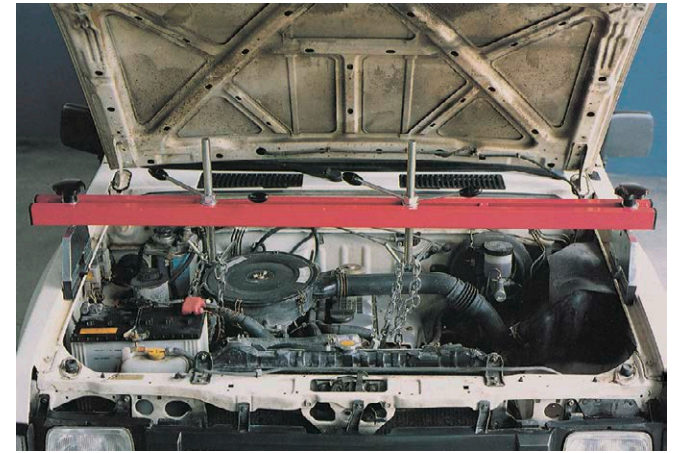

Title	Bearing Load, Max.	PU Piece	Article No.
111 ENGINE HOIST AGR: 08.001	500 kg	1	880280

16

LED Pen Light 7+1

- Practical and handy LED light
- 7 bright LEDs of the latest generation for the main light and 1 bright LED as spot
- Magnet and pocket clip on the back
- Micro USB charging socket
- Very handy and practical
- Small format for the bag

Hints

- The set includes 1 car charger USB, 1 USB cable and 1 USB charger

Scope Of Delivery

- LED Pen Light 7+1 without charger

Technical Data

Runtime	3.5 h
Charging Time (Standard)	3 h
Accumulator	Li-Ion, 3.7 V, 750 mAh
Luminous flux main light High	90 lm
Brightness main light High	150 Lux @ 0.5 m
Brightness spotlight	100 Lux @ 0.5 m
Performance	1.2 W
Type of LED	SMD
Degree Of Protection	IP20
Length x width x thickness	170 x 22 x 25 mm
Weight	57 g

Title	PU Piece	Article No.
LED Pen Light 7+1 Micro USB	1/3/5/10/15/ 30	200559

AGR: 08.200

Accessories Available	PU Piece	Article No.
Mirco USB Car charger universal	1	214954
USB cable Micro USB	1	201071

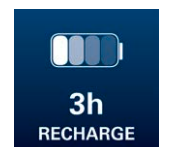

Pocket Lux "Bright"

- Latest LED technology
- Special design for optical lens for soft and bright light with a 90° scattering
- Better light of the workplace possible
- 1W high power LED spot light supply 600 Lux at 0,5m light output
- 180° bendable for flexible fixing position
- Strong magnets on the bottom and back side for different and iflexible fixing position
- Two hooks for additional fixing possibilities
- Intelligent load broad, recognizes the wrong charger

Hints

- Rechargeable with standard chargers with Micro USB connector
- Free of mercury and other hazardous gases

Scope Of Delivery

- Pocket Lux "Bright" Micro USB without charger

Technical Data

Runtime	3 h
Charging Time (Standard)	4 h
Accumulator	Li-Ion, 3.7 V, 2100 mAh
Luminous flux main light High	250 lm
Brightness main light High	450 Lux @ 0.5 m
Performance	5 W
Degree Of Protection	IP20
Length x width x thickness	250 x 56 x 44 mm
Weight	290 g
Colour temperature	5650 K - 6500 K

Title	PU Piece	Article No.
Pocket Lux "Bright" Micro USB	1/5/10/15/30	206956

AGR: 08.200

Accessories Available	PU Piece	Article No.
USB cable Micro USB	1	201071
Mirco USB Car charger universal	1	214954

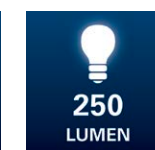
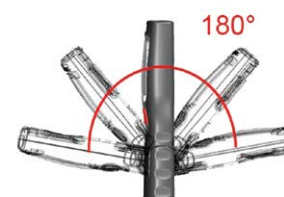

Pocket DAYlight

- Latest LED technology with 6 high power LEDs
- Special design for optical lens for soft and bright light with a 90° scattering
- Better light of the workplace possible
- 3W high power LED UV spot for example leak detection
- 180° bendable for flexible fixing position
- Strong magnets on the bottom and back side for different and flexible fixing position
- Two hooks for additional fixing possibilities
- Intelligent load broad, recognizes the wrong charger

Application Area

- The lighting in car body repair shops is often not optimal. Especially in the dark winter months, makes this deficit noticeable
- For this reason, the universal DAYlight lamp is a "must" for every repair specialist. Not only for smart repair but also for the precise determination of shades
- for workplace lighting on construction sides, factories and garages. Ideal for maintenance and the professional use
- DAYlight is perfect for any paint, polish, cleaning or prep-zone operation

Hints

- Chargable with a common charger with a micro USB plug

Technical Data

Runtime	3 h
Charging Time (Standard)	5 h
Accumulator	Li-Ion, 3.7 V, 2100 mAh
Luminous flux main light High	240 lm
Brightness main light High	300 Lux @ 0.5 m
Type of LED	SMD
Degree Of Protection	IP20
Length x width x thickness	250 x 56 x 44 mm
Weight	294 g

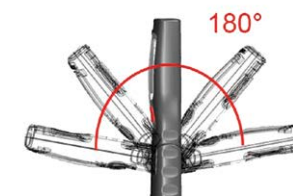
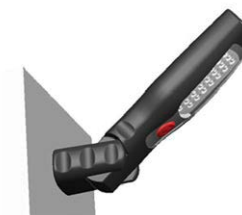

INTERNAL/Approved (2019-03-23 00:26:20)

Title	PU Piece	Article No.
Pocket DAYlight	1	244408

AGR: 08.200

Accessories Available

	PU Amount	Article No.
Mirco USB Car charger universal	1	214954
USB cable Micro USB	1	201071

Pocket deLUX "Bright"

- Latest LED stripes
- Special optical lens for soft, bright light with a dispersion of 90 °
- A larger lighting of the workplace than with previous LED technology is made possible
- Rotates 360 ° for more applications
- 360 ° swivel hook
- Strong magnet in base for secure hold
- Belt clip in frame
- Micro USB charging socket
- Smart charger detects wrong charger

Scope Of Delivery

- Pocket deLUX "Bright" Micro USB without charger

Technical Data

Runtime	2 h
Charging Time (Standard)	4 h
Accumulator	Li-Ion, 3.7 V, 1200 mAh
Luminous flux main light High	150 lm
Brightness main light High	400 Lux @ 0.5 m
Performance	3.5 W
Degree Of Protection	IP20
Length x width x thickness	130 x 66 x 28 mm
Weight	190 g

Title	PU Piece	Article No.
Pocket deLux "Bright" Micro USB	1/3/5/10/15/30	206958

AGR: 08.200

Accessories Available

	PU Piece	Article No.
Mirco USB Car charger universal	1	214954
USB cable Micro USB	1	201071

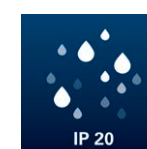
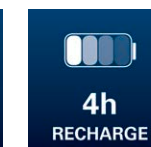

Pocket DeLUX Bright ECO Micro USB

Title	PU Piece	Article No.
Pocket DeLUX Bright ECO Micro USB	1/5/10	244407

AGR: 08.200

Accessories Available	PU Amount	Article No.
Mirco USB Car charger universal	1	214954
USB cable Micro USB	1	201071

Pocket deLUX "SUN"

- 2 ultra-bright LEDs of the new generation brings 40% more light and illuminate the work of a large area
- 340° pivoting lamp for lots of application
- 360° rotatable integrated hook enable endless different positions
- Strong magnet on the bottom for secure hold
- Pocket clip

Hints

- Micro USB charging socket
- Free of mercury and other hazardous gases

Scope Of Delivery

- Pocket deLUX "SUN" Micro USB without charger

Technical Data

Runtime	4 h
Charging Time (Standard)	4 h
Accumulator	Li-Ion, 3.7 V, 1200 mAh
Luminous flux main light High	150 lm
Brightness main light High	2000 Lux @ 0.5 m
Degree Of Protection	IP20
Length x width x thickness	130 x 66 x 28 mm
Weight	177 g

Title	PU Piece	Article No.
Pocket Delux "Sun" Micro USB	1/3	206957
AGR: 08.200		
Accessories Available	PU Piece	Article No.
USB cable Micro USB	1	201071
Mirco USB Car charger universal	1	214954



Pocket Lux Slim

- 15 SMD front - facing LED's provide a high light output to work surface
- Ultra slim (8 mm) for hard to reach area
- Robust Aluminum - plastic housing
- Bright and Broad 600 lumen, 90 degree illumination and 4 hours operation
- Two levels illumination
- 150 degree rotatable with strong magnet on bottom
- Retractable swivel hook
- On - going Battery indicator
- Multi - function switch toggles between 1st level and 2level LED - illumination

Hints

- Chargable with a common charger with a micro USB plug

Scope Of Delivery

- Pocket Lux Slim without charger

Technical Data

Runtime	4 h
Runtime low level	7 h
Charging Time (Standard)	5.5 h
Accumulator	Li-Ion, 3.7 V, 4400 mAh
Luminous flux main light High	600 lm
Luminous flux main light Low	300 lm
Brightness main light High	900 Lux @ 0.5 m
Type of LED	SMD
Degree Of Protection	IP20
Length x width x thickness	345 x 44 x 24 mm
Weight	218 g

Title	PU Piece	Article No.
Pocket Lux Slim	1/5/10/15/ 30	244406

AGR: 08.200



INTERNAL/Approved (2019-03-23 00:27:12)

Accessories Available

	PU Amount	Article No.
Mirco USB Car charger universal	1	214954
Rubber Cover for Pocket Lux Slim	1	244794
USB cable Micro USB	1	201071

Rubber Cover for Pocket Lux Slim

Title	PU Piece	Article No.
Rubber Cover for Pocket Lux Slim	1	244794

AGR: 08.200



Pocket deLux Bright Premium

- Small & with belt clip for pocket
- 360° rotatable hook and 270° fold design for a better light distribution
- Strong built-in magnet on the bottom, for variable positioning
- Smart battery indicator
- Robust aluminum - Plastic housing with slim design
- 3+1 SMD LED lamp provides up to 3 hours continuous operation
- Micro USB charging port with rubber protection
- Intelligent load broad, recognizes the wrong charger

Technical Data

Runtime	3 h
Charging Time (Standard)	3 h
Accumulator	Li-Ion, 3.7 V, 2000 mAh
Luminous flux main light High	250 lm
Brightness main light High	550 Lux @ 0.5 m
Brightness spotlight	450 Lux @ 0.5 m
Degree Of Protection	IP20
Length x width x thickness	133 x 65 x 23 mm
Weight	173 g

Title	PU Piece	Article No.
Pocket deLux Bright Premium	1/3/5/10/15/30	249057

AGR: 08.200

Accessories Available	PU Amount	Article No.
Mirco USB Car charger universal	1	214954
USB cable Micro USB	1	201071

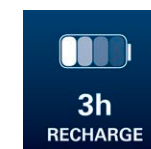

Pen Light Premium Micro USB

- Practical and handy LED light
- 6 bright LED's of the newest generation for the main light, 1 bright LED for the spot light
- Magnet and pocket clip on the back
- Handy and small size for the pocket
- Micro USB charging port
- Intelligent load broad, recognizes the wrong chargerMicro USB



Technical Data

Runtime	2.5 h
Charging Time (Standard)	2.5 h
Accumulator	Li-Ion, 3.7 V, 800 mAh
Luminous flux main light High	150 lm
Brightness main light High	500 Lux @ 0.5 m
Brightness spotlight	300 Lux @ 0.5 m
Degree Of Protection	IP20
Length x width x thickness	177 x 23 x 20 mm
Weight	65 g



Title	PU Piece	Article No.
Pen Light Premium Micro USB	1/5/10/15/ 30	249056

AGR: 08.200

Accessories Available	PU Amount	Article No.
Mirco USB Car charger universal	1	214954
USB cable Micro USB	1	201071

Slimlite Easy

- Extra slim design
 - Especially adapted to narrow spaces
 - Ideal for working in difficult to reach areas
- Optical lens with a 90° light angle
- Universal micro USB charging socket
 - Convenient charging using any charger that has a micro USB connector, e.g. mobile phone charger, computer...
- IP42 with protective cap
 - Improved version with better IP protection
- Upgraded battery amperage and 2 lighting levels
 - Improved working time
 - Adaptable luminous intensity



Hints

- Universal micro USB charging socket
- 2 level lighting according to the needs

Scope Of Delivery

- Lamp delivered without cable and charger



Technical Data

Runtime	3 h
Runtime low level	6 h
Charging Time (Standard)	5 h
Accumulator	Li-Ion, 3.7 V, 2600 mAh
Luminous flux main light High	400 lm
Luminous flux main light Low	200 lm
Brightness main light High	900 Lux @ 0.5 m
Brightness main light Low	450 Lux @ 0.5 m
Performance	3 W
Type of LED	SMD
Connector type	Micro USB
Degree Of Protection	IP42
Length x width x thickness	262 x 32 x 23.6 mm
Weight	180 g

Title	PU Piece	Article No.
Slimlite Easy	1	365815

AGR: 08.200

INTERNAL/Approved (2019-03-23 00:27:54)

Promotion Case Premium LED-Lamps

- Promotion Case with all LED-Handlamps Premium Micro USB, inclusive charger and charging cable in the practical Smart-Box
- Foam Inlay fits in the workshop trolley

Title	PU Assortment	Article No.
Promotion Case Premium LED-Lamps	1	336052
AGR: 08.200		
Scope Of Supply	Amount	Article No.
Charger USB	1	-
Foam Inlay for Premium lamps Case empty	1	335920
Pen Light Premium Micro USB	1	249056
Pocket deLux Bright Prermium	1	249057
Pocket Lux Slim	1	244406
Rubber Cover for Pocket Lux Slim	1	244794
Open-Jawed and Ring Ratchet Wrench	1	043572
USB cable Micro USB	1	201071



LED Broadfix

- The special tube produces a soft, bright and wide light
- The light scattering is 180 ° and provides good illumination of the work area
- No heat warming and very low power consumption thanks to the latest LED technology
- Integrated spot light for punctual illumination
- Can be started from cold (down to -40°C)

Hints

- Free of mercury and other hazardous gases

Scope Of Delivery

- LED Broadfix with Spot Micro USB without charger

Technical Data

Runtime	3 h
Charging Time (Standard)	3.5 h
Accumulator	Li-Ion, 3.7 V, 3300 mAh
Brightness main light High	500 Lux @ 0.5 m
Degree Of Protection	IP65
Length x width x thickness	500 x 50 mm
Weight	318 g

Title	PU Piece	Article No.
LED Broadfix Cordless Micro USB	1	206955

AGR: 08.200

Accessories Available	PU Piece	Article No.
Mirco USB Car charger universal	1	214954
USB cable Micro USB	1	201071

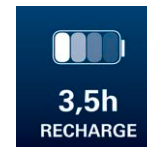
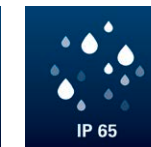

USB Chargers and accessory

Technical Data

Type Of Lamp LED

Title	Cable Length	PU Piece	Article No.
Mirco USB Car charger universal	-	1	214954
USB cable Micro USB	1000 mm	1	201071

AGR: 08.202



16

Pack best of lamps big

Title	PU Package	Article No.
BEST OF LAMPS BIG	1	219085

AGR: 08.200

Scope Of Supply

	Piece	Article No.
LED Pen Light 7+1 Micro USB	1	200559
Pocket Lux "Bright" Micro USB without charger	1	206956
Charger USB	1	-
USB cable Micro USB	1	201071



INTERNAL/Approved (2019-03-23 00:28:20)

Lamp Set Headlight & Penlight

Title	PU Package	Article No.
Lamp Set Headlight & Penlight	1	339200

AGR: 08.200



Pocket Flooder 10W

- Innovative small rechargeable LED floodlight 10W with micro USB connector.
- Powerfull : 1000 Lumens (same power as 7 Pockets deLux !).
- Large lighting zone area of 2 meters.
- Combine applications of hand LED lamps and floodlights.
- Compact, hold in one hand.
- Time saving : easy and quick to install.
- Totally flexible : equipped with a bracket included 2 magnets. Adaptable everywhere with the universal clip (sold separatly).
- Rechargeable battery with high capacity.
- IP65- Better resistance to water and dust for working in garags and construction area.



With the universal clip sold separatly.

Hints

- The bracket included 2 powerfull magnets is easily to replace.
- The Magnet cover pad is a spare part to protect from scratches if the Pocket flooder is positioning on sensible metals parts (painting car body).

Technical Data

Runtime	3 h
Runtime low level	6 h
Charging Time (Standard)	5.5 h
Accumulator	Li-Ion, 3.7 V, 4400 mAh
Luminous flux main light High	1000 lm

Light engineering and shiners

Luminous flux main light Low	500 lm
Brightness main light High	1500 Lux @ 0.5 m
Brightness main light Low	750 Lux @ 0.5 m
Performance	10 W
Degree Of Protection	IP 65
Length x width x thickness	140 x 89 x 45 mm
Weight	400 g

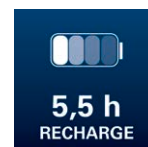

Title	PU Piece	Article No.
Pocket Flooder 10W	1/5	341709
AGR: 08.201		
Accessories Available		
	PU Piece	Article No.
Universal clip for Pocket Flooder 10W	1/3/5	341711
USB cable Micro USB	1	201071
Mirco USB Car charger universal	1	214954
Spare Parts		
	PU Amount	Article No.
Bracket for pocket flooder10 W	1	341710

Universal clip for Pocket Flooder 10W

- Easy installation
 - ▶ On the bracket with the dedicated hole
 - ▶ Opening capacity of 60 mm
- Can be installed everywhere
 - ▶ Construction sites: on a window, ladder, scaffolding
 - ▶ Automotive: on difficult to reach places, thanks to included magnets

Application Area

- For an easily installation of the Pocket flooder 10W everywhere.
- Construction area : on a windows, a ladder, a scaffolding.
- Automotive area : all parts without acessibility to install the Pocker flooder with included magnets.

Characteristics

- Easy fix on the bracket with the dedicated hole.
- Opening capacity : 60 mm.

Scope Of Delivery

- With manual screw M8.



Title	PU Piece	Article No.
Universal clip for Pocket Flooder 10W	1/3/5	341711

AGR: 08.201

Spare parts for Pocket Flooder 10W

Application Area

- The bracket included 2 powerfull magnets is easily to replaceable with 4 screws at the back of the Pocket Flooder.
- The Magnet cover pad is a spare part to protect from scratches if the Pocket flooder is positinning on sensible metals parts (painting car body).

Title	PU Piece	Article No.
Bracket for pocket flooder10 W	1	341710

AGR: 08.201



INTERNAL/Approved (2019-03-23 00:29:06)

LED-Lamp Flexi-Lux

- Magnetic LED lamp with flexible cable
- Hands-free operation through magnetic adhesion on grip

Application Area

- Illumination of inaccessible angles through flexible 35 cm long cable
- Targeted retrieval of metallic small parts through magnetic lamp head

Characteristics

- Bright white light

Scope Of Delivery

- Inclusive 3 button cells LR 44

Title	PU Piece	Article No.
Flexi-Lux	1	001318
AGR: 08.200		
Spare Parts	PU Piece	Article No.
BUTTN CELL LR 44 1.5V 2PT-BLIS	1	175965



LED Inspection Stick With Mirror

Technical Data

Type Of Lamp	LED
Batteries	3 x LR41
Length, Minimum Or Single Value	165 mm
Length, Maximum	660 mm
Diameter	8 mm

Title	PU Piece	Article No.
LED INSPECTIONS STICK W MIRROR	1	129352

AGR: 08.204

Spare Parts	PU Piece	Article No.
BUTTON CELL LR41	1	185046
STICK INSPECTION MIRROR	1	128907



LED-Spot Hand Lamp 6V

Title	PU Piece	Article No.
LED-SPOT HAND LAMP 6V	1	092681

AGR: 08.200

Spare Parts	PU Piece	Article No.
DRY BATTERY TYP 800 6V	1/20	086553



16

Magnetic Telescope Pocket Lamp

Title	PU Piece	Article No.
MAGNETIC TELESCOPE POCKET LAMP	1	129475

AGR: 08.200

Spare Parts	PU Piece	Article No.
BUTTN CELL LR 44 1.5V 2PT-BLIS	1	175965



LED Power Flashlight Midi

Title	PU Piece	Article No.
LED-POWER FLASHLIGHT MIDI	1	156515

AGR: 08.204



LED Power Flashlight Maxi

Title	PU Piece	Article No.
LED-POWER FLASHLIGHT MAXI	1	156518

AGR: 08.204



Headlight 2 in 1 Accu

- In contrast to conventional headlamps which generate a light cone, the new headlamp 2 in 1 provides an optimal working light by illuminating the entire working area
- Removable headlamp, can also be used as a work lamp without headband
- With strong, built-in magnet
- 180 ° folding design for flexible lighting
- Micro USB charging socket with rubber protection cap
- Smart charger detects wrong charger
- Waterproof and dustproof



Technical Data

Runtime	4 h
Runtime low level	8 h
Charging Time (Standard)	4 h
Accumulator	Li-Ion, 3.7 V, 2000 mAh
Luminous flux main light High	250 lm
Luminous flux main light Low	120 lm
Brightness main light High	500 Lux @ 0.5 m
Brightness main light Low	250 Lux @ 0.5 m
Degree Of Protection	IP 65
Weight	147 g

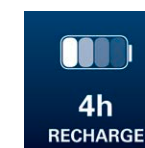
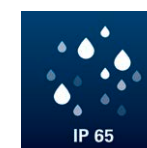

Title	PU Piece	Article No.
Headlight 2 in 1 Accu	1	335506
AGR: 08.200		
Accessories Available	PU Amount	Article No.
Mirco USB Car charger universal	1	214954
USB cable Micro USB	1	201071
Spare Parts	PU Amount	Article No.
Head Belt for Headlight 2 in 1	1	335508
Lamp for Headlight 2 in 1 Accu	1	335507

Head lamp LED Bright Star

Title	PU Piece	Article No.
HEAD LAMP BRIGHT STAR	1	206967
AGR: 08.200		



16

Head torch Multifunctional

Title	PU Piece	Article No.
Head torch Multifunctional	1	339275
AGR: 08.200		



Rear lamp for Head Torch

Title	PU Piece	Article No.
Rear lamp for Head Torch AGR: 08.200	1	339276



Safety Flashlight Zone 1

- No electrical charge of the casing
- Light ON time LED up to 50 hours
- Light ON time XENON up to 3 hours
- ATEX and IECEx certification (international standard)
- High lumen value for all covering illumination
- LED = 50 Lumen
- XENON = 80 Lumen
- Protection against short-circuit and falsely placed batteries
- 100% water and dust-proof



*Atex
compatible
(dangerous
zones)*

Application Area

- Places, with an explosive atmosphere (industrial facilities, machines, workplaces ,...)
- Public safety institutions e.g. brigade, police, rescue services
- Industry
- Handicraft
- Processing industry (Chemical industry, pharmacy, ...)

Characteristics

- Zone 1: Explosive atmospheres are present
- Zone 1: LED
- II 2G Ex ib IIB T4 Gb
- II 2D Ex ib IIIC T 105 ° C Db IP68
- Ex ib IIB T4 Gb
- Ex ib IIIC T 105 ° C Db IP68
- Zone 1: XENON
- II 2G Ex ib IIB T4 Gb s
- Ex ib IIB T4 Gb s

Hints

- Incl. 4 x AA Alkaline AA (LR06) batteries
- Only use original batteries (kind. 91578), otherwise no approval
- Dimensions: 16.7 x 3.8 cm

Technical Data

Max. light output	120 lm
Length	16.7 cm
Width	3.8 cm

Title	PU Piece	Article No.
Safety Flashlight LED	1	092783

AGR: 08.200

Spare Parts	PU Piece	Article No.
Battery Mignon LR6 1,5 V X-tra	1/10	332674

Flashlight LED-Standard

Title	PU Piece	Article No.
Flashlight LED-Standard	1	335298

AGR: 08.200



Charger for LED-light I-Lux Easy

Title	PU Piece	Article No.
I-Lux Easy 12V Car Charger Plug	1	042315

AGR: 08.202



Charger 230V for Pocket-Lux LED

Technical Data

Type Of Lamp	LED	
--------------	-----	--

Title	PU Piece	Article No.
Pocket Lux Charger 12/24 V	1	088778

AGR: 08.202

Spare Parts	PU Amount	Article No.
Spare Glass Panel for Pocket Lux	1/5	097548



Pocket DeLux Wireless

- True innovation
 - ▶ New Berner wireless technology for hand lamps
- Very convenient
 - ▶ Ergonomic design
 - ▶ Safe in use
- Adaptable lighting intensity and run time



Light engineering and shiners

- ▶ Dimmable switch with memory function allows to work 2 hours with maximum power to 8 hours with low power, 350 to 50 lumens.
- Simplifies work
 - ▶ Quick and efficient charging
 - ▶ No need to plug your lamp using a cable
 - ▶ Magnets on the back for quick positioning of the lamp onto the charging panel
 - ▶ Magnets on bottom and back for positioning on any steel piece
- Easy to use
 - ▶ Dynamic charging
 - ▶ Simply place your lamp directly onto the wireless charging pad and charging starts
- Useful battery charging indicator
 - ▶ The indicator is activated 10 s after positioning the lamp on the charging panel
 - ▶ A red flashing alert automatically appears when the battery level is less than 25%
- Adjustable lighting zone
 - ▶ 180 degree rotatable design

Technical Data

Runtime	2 h
Runtime low level	8 h
Charging Time (Standard)	2.5 h
Luminous flux main light High	300 lm
Luminous flux main light Low	30 lm
Luminous flux spot light	100 lm
Brightness main light High	350 Lux @ 0.5 m
Brightness main light Low	40 Lux @ 0.5 m
Brightness spotlight	450 Lux @ 0.5 m
Performance	3 W
Type of LED	COB
Connector type	Wireless
Degree Of Protection	IP 65
Length x width x thickness	134 x 65 x 24 mm



2 magnets on back



Hook up part for easy install



Spot light



180° rotatable with included magnets



Dimming switch function

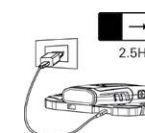

Title	PU Piece	Article No.
Pocket Delux Wireless	1	367170
AGR: 08.200		
Necessary Accessories	PU Amount	Article No.
Wireless charging dual pad pack	1	367167
Wireless charging single pad pack	1	367166

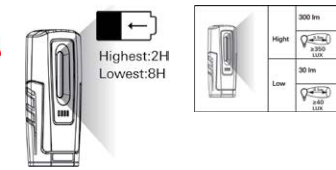

X-Lux Wireless

- True innovation
 - ▶ New Berner wireless technology for hand lamps
- Very convenient
 - ▶ Ergonomic design
 - ▶ Safe in use
- Adaptable lighting intensity and run time



Light engineering and shiners

- ▶ Dimmable switch with memory function allows to work 3 hours with maximum power to 8 hours with low power, 400 to 40 lumens
- Simplifies work
 - ▶ Quick and efficient charging
 - ▶ No need to plug your lamp using a cable
 - ▶ Magnets on the back for quick positioning of the lamp onto the charging panel
 - ▶ Magnets on bottom and back for positioning on any steel piece
- Easy to use
 - ▶ Dynamic charging
 - ▶ Simply place your lamp directly onto the wireless charging pad and charging starts
- Useful battery charging indicator
 - ▶ The indicator is activated 10 s after positioning the lamp on the charging panel
 - ▶ A red flashing alert automatically appears when the battery level is less than 25%
- Adjustable lighting zone
 - ▶ 150 degree rotatable design

Technical Data

Runtime	3 h
Runtime low level	8 h
Charging Time (Standard)	4.5 h
Luminous flux main light High	400 lm
Luminous flux main light Low	40 lm
Luminous flux spot light	300 lm
Brightness main light High	600 Lux @ 0.5 m
Brightness main light Low	65 Lux @ 0.5 m
Brightness spotlight	850 Lux @ 0.5 m
Performance	5 W
Type of LED	COB
Connector type	Wireless
Degree Of Protection	IP 65
Length x width x thickness	250 x 55 x 37 mm

Title	PU Piece	Article No.
X-Lux Wireless	1	367171

AGR: 08.200



Hook up part for easy install



2 magnets on back



Spot light



150° rotatable with included magnets



Dimming switch function



Wireless

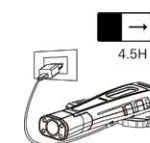

Necessary Accessories	PU Amount	Article No.
Wireless charging dual pad pack	1	367167
Wireless charging single pad pack	1	367166

Full Pack Wireless charging dual pad & Wireless Pocket Delux + X-Lux

- Ready to use
 - ▶ A full pack of wireless charging system including the charging single pad with accessories (cable and 230V-2A charger) together with the Pocket DeLux + X-Lux lamp
- True innovation
 - ▶ New Berner wireless technology system with patent pending
 - ▶ For wireless lamps and compatible with smartphones
- Easy to use
 - ▶ Dynamic charging
 - ▶ Simply place the lamp directly onto the charging pad and charging begins
 - ▶ System compatible with wireless smartphones
- Simplifies work
 - ▶ Quick and efficient dynamic charging
 - ▶ No need to plug your device with a cable
- Useful LED indicators
 - ▶ On the panel: Green LED means the wireless panel is connected and USB output is working
 - ▶ Red LED means the lamp is charging on the wireless charger and USB output is not available
 - ▶ On the lamp: to see the charge level of the included battery
- Very convenient
 - ▶ Power sender mark on the middle with positioning magnets to ensure the right position of the lamp for charging
 - ▶ Positioning magnets on the back can be used for sticking on wall steel panels
 - ▶ Side handle for easy removal from steel panels
 - ▶ 4 screw holes for fixing on non ferromagnetic panels
- Strong performance of the lamp
 - ▶ Dimmable illumination for adaptable lifetime from 2 to 8 hours for the Pocket DeLux, 3 to 8 hours for the X-Lux
- Robust and proven daily use
 - ▶ IP65 protection against water, oil and dust
- 2-in-1 advantage



- ▶ Combines the strengths of an LED torch and a LED spotlight

Title	PU Piece	Article No.
Full Pack Wireless charging dual pad+2 lamps	1	367175
AGR: 08.200		
Scope Of Supply		
Pocket Delux Wireless IP65	1	367170
Wireless charging dual pad pack	1	367167
X-Lux Wireless IP65	1	367171
Accessories Available		
USB charging multicable 3 in 1 - Micro USB, Typ-C, Lightning	1	367172
Spare Parts		
Charger 230V/ USB 5V-2A	1	367177
Pocket Delux Wireless IP65	1	367170
USB cable Micro USB	1	201071
X-Lux Wireless IP65	1	367171

16

Full Pack Wireless charging single pad & Wireless X-Lux

- Ready to use
 - ▶ A full pack of wireless charging system including the charging single pad with accessories (cable and 230V-1A charger) together with the Pocket DeLux lamp
- True innovation
 - ▶ New Berner wireless technology system with patent pending
 - ▶ For wireless lamps and compatible with smartphones
- Easy to use



- ▶ Dynamic charging
- ▶ Simply place the lamp directly onto the charging pad and charging begins
- ▶ System compatible with wireless smartphone
- Simplifies work
 - ▶ Quick and efficient dynamic charging
 - ▶ No need to plug your device with a cable
- Useful LED indicators
 - ▶ On the panel: Green LED means the wireless panel is connected and USB output is working
 - ▶ Red LED means the lamp is charging on the wireless charger and USB output is not available
 - ▶ On the lamp: to see the charge level of the included battery
- Very convenient
 - ▶ Power sender mark on the middle with positioning magnets to ensure the right position of the lamp for charging
 - ▶ Positioning magnets on the back can be used for sticking on wall steel panels
 - ▶ Side handle for easy removal from steel panels
 - ▶ 4 screw holes for fixing on non ferromagnetic panels
- Strong performance of the lamp
 - ▶ Dimmable illumination for adaptable lifetime from 3 to 8 hours
- Robust and proven daily use
 - ▶ IP65 protection against water, oil and dust
- 2-in-1 advantage
 - ▶ Combines the strengths of a LED torch and a LED spotlight



Title	PU Piece	Article No.
Pack Wireless X-Lux Platinum	1	367174
AGR: 08.200		
Scope Of Supply	Amount	Article No.
Wireless charging single pad pack	1	367166
X-Lux Wireless IP65	1	367171
Accessories Available	PU Amount	Article No.
USB charging multicable 3 in 1 - Micro USB, Typ-C, Lightning	1	367172

INTERNAL/Approved (2019-03-23 00:31:18)

Spare Parts	PU Amount	Article No.
Charger 230V/ USB 5V-1A	1	367176
USB cable Micro USB	1	201071
X-Lux Wireless IP65	1	367171

Full Pack Wireless charging single pad & Wireless Pocket DeLux

- Ready to use
 - ▶ A full pack of wireless charging system including the charging single pad with accessories (cable and 230V-1A charger) together with the Pocket DeLux lamp
- True innovation
 - ▶ New Berner wireless technology system with patent pending
 - ▶ For wireless lamps and compatible with smartphones
- Easy to use
 - ▶ Dynamic charging
 - ▶ Simply place the lamp directly onto the charging pad and charging starts
 - ▶ System compatible even with wireless smartphone
- Simplifies work
 - ▶ Quick and efficient dynamic charging
 - ▶ No need to plug your device with a cable
- Useful LED indicators
 - ▶ On the panel: Green LED means the wireless panel is connected and USB output is working
 - ▶ Red LED means the lamp is charging on the wireless charger and USB output is not available
 - ▶ On the lamp: to see the charge level of the included battery
- Very convenient
 - ▶ Power sender mark on the middle with positioning magnets to ensure the right position of the lamp for charging
 - ▶ Positioning magnets on the back can be used for sticking on wall steel panels
 - ▶ Side handle for easy removal from steel panels
 - ▶ 4 screw holes for fixing on non ferromagnetic panels
- Strong performance of the lamp
 - ▶ Dimmable illumination for adaptable lifetime from 2 to 8 hours
- Robust and proven daily use
 - ▶ IP65 protection against water, oil and dust

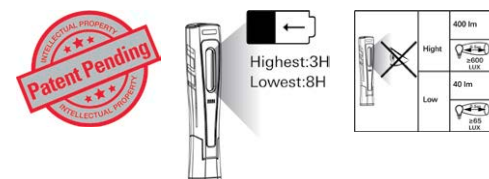

- 2-in-1 advantage
 - ▶ Combines the strengths of an LED torch and of a LED spotlight

Title	PU Piece	Article No.
Pack Wireless Pocket Platinum	1	367173
AGR: 08.200		
Scope Of Supply	Amount	Article No.
Pocket Delux Wireless IP65	1	367170
Wireless charging single pad pack	1	367166
Accessories Available	PU Amount	Article No.
USB charging multicable 3 in 1 - Micro USB, Typ-C, Lightning	1	367172
Spare Parts	PU Amount	Article No.
Charger 230V/ USB 5V-1A	1	367176
Pocket Delux Wireless IP65	1	367170
USB cable Micro USB	1	201071

Wireless charging dual pad pack

- True innovation
 - ▶ New Berner wireless charging pad technology for wireless lamps
 - ▶ Compatible with smartphones
- Strong performance
 - ▶ Quick and efficient charging of 2 wireless lamps at the same time
- Simplifies work
 - ▶ Quick and efficient charging
 - ▶ No need to plug your device with a cable
- Ready to use
 - ▶ Dynamic charging
 - ▶ Simply place your device directly onto the charging pad and your lamp or smartphone begins to charge
- Useful LED indicators
 - ▶ Green LED means the wireless panel is connected and USB output is working
 - ▶ Red LED means 1 lamp minimum is charging on the wireless charger and USB output is not available
- Very convenient



Light engineering and shiners

- ▶ Power sender mark on the middle with positioning magnets to ensure the right position of the lamp for charging
- ▶ Positioning magnets on back can be used to stick on wall steel panels
- ▶ Side handle for easy removal from steel panel
- ▶ 4 screws holes for fixing non ferromagnetic panel

Processing Information

- Only use the included grey Berner charger Charger 230V/ USB 5V-2A

Hints

- Possible to charge 2 wireless devices on the same time : 1 lamp+1 smartpone
- Never stop lighting with 1 lamp using/ 1lamp charging
- 5V Micro USB input (charger 2A needed)
USB output (2A max when no light charged by wireless)

Technical Data

Rated Voltage	5 V
Length x width x thickness	208 x 99 x 13 mm

Title	PU Piece	Article No.
Wireless charging dual pad	1	367167

AGR: 08.202

Necessary Accessories	PU Amount	Article No.
Pocket Delux Wireless IP65	1	367170
X-Lux Wireless IP65	1	367171

Scope Of Supply	Amount	Article No.
Charger 230V/ USB 5V-2A	1	367177
USB cable Micro USB	1	201071
Wireless charging dual pad	1	-

Wireless charging single pad pack

- True innovation
 - ▶ New Berner wireless charging pad technology for wireless lamps
 - ▶ Compatible with smartphones
- Simplifies work
 - ▶ Quick and efficient charging
 - ▶ No need to plug your device with a cable
- Ready to use
 - ▶ Dynamic charging
 - ▶ Simply place your device directly onto the charging pad and your lamp or smartphone begins to charge
- Useful LED indicators
 - ▶ Green LED means the wireless panel is connected and USB output is working
 - ▶ Red LED means lamp is charging on the wireless charger and USB output is not available
- Very convenient
 - ▶ Power sender mark on the middle with positioning magnets to ensure the right position of the lamp for charging
 - ▶ Positioning magnets on back can be used to stick on wall steel panels
 - ▶ Side handle for easy removal from steel panel
 - ▶ 4 screws holes for fixing non ferromagnetic panel



Characteristics

- 5V Micro USB input
- USB output (1A max when no light charged by wireless)

Processing Information

- Only use the included Berner charger Charger 230V/ USB 5V-1A

Technical Data

Rated Voltage	5 V
Length x width x thickness	174 x 99 x 13 mm

Title	PU Piece	Article No.
Wireless charging single pad pack	1	367166

AGR: 08.202

Necessary Accessories	PU Amount	Article No.
Pocket Delux Wireless IP65	1	367170

INTERNAL/Approved (2019-03-23 00:32:08)

USB charging multicable 3 in 1 - Micro USB, Typ-C, Lightning

- 3 in 1 product
 - ▶ Combines the 3 most common connectors in 1 cable: USB to Micro USB, Typ-C, Lightning
- Very convenient
 - ▶ Only one cable for all your mobile devices, lamps, smartphones
 - ▶ Cable does not get tangled thanks to the nylon component
 - ▶ Suitable for data transfer from smartphones and computers

Processing Information

- Connect an external 5V1A adapter with a USB output

Technical Data

Material Nylon with PVC-coating

Title	Cable Length	PU Piece	Article No.
USB charging multicable 3 in 1	1450 mm	1	367172

AGR: 08.202

Accessories Available	PU Amount	Article No.
Charger 230V/ USB 5V-1A	1	367176
Wireless charging dual pad pack	1	367167
Wireless charging single pad pack	1	367166



Chargers 230V/ USB

- 2-in-1 advantage
 - Designed for Berner LED lamps and wireless charging panels
 - Also for all USB chargeable products
- Simplifies work
 - The black charger 230V/ USB 5V-1A is recommended for the whole range of LED hand lamps with micro USB connector (1A needed)
 - The grey charger 230V/ USB 5V-2A is recommended for the new Dual charging panels that need a higher amperage (2A)
- Everyday use
 - Turn your electrical outlet into a USB connector
 - Internal circuit designed to prevent short circuits or voltage jumps

Hints

- All existing lamps included a regulator to 1A. The 2A is only recommended for the wireless dual charging panel
- Black charger model 230V/ USB 5V-1A
INPUT: 100-240V~ 0,5A
OUTPUT: 5V, 1A
- Grey charger 230V/ USB 5V-2A
INPUT 100-240V~ 0,5A
OUTPUT: 5V, 2A

Technical Data

Voltage area input 100-240V ; 0,5A

Title	Voltage area output	PU Piece	Article No.
Charger 230V/ USB	5V - 1A	1	367176
Charger 230V/ USB	5V - 2A	1	367177

AGR: 08.202

Necessary Accessories	PU Amount	Article No.
USB cable Micro USB	1	201071

INTERNAL/Approved (2019-03-23 00:32:27)

Berner Flashlight, 8 watts and 4 watts

- Noise-suppressed, with protective insulation for guaranteed safe operation
- Rotatable hook enables flexible operation

Characteristics

- Impact-proof, shock-proof, resistant against most acids and oils, incl. cable and hook



Title	Performance	Voltage	Cable Length	Length total (mm)	PU Piece	Article No.
Flashlight, 8 watts	8 W	220 V	5 m	480 mm	1	123638

AGR: 08.202

Replacement parts for Cleverlight

Technical Data

Length	300 mm
--------	--------

Title	Performance	Voltage	Type Of Lamp	PU Piece	Article No.
Fluorescent Light	8 W	220 V	Neon	1	015911

AGR: 08.202

Accessories Available

	PU Piece	Article No.
Magnetic holder	1	015920



LED STAFF LAMP S

- Due to the special tube creates a soft, light and wide light
- The light output is 180 °
- The work area is very well lit
- No heat generation and low power consumption by newest LED technology



Technical Data

Degree Of Protection IP20

Title	Cable Length	PU Piece	Article No.
LED STAFF LAMP S	5 m	1/3/5	207850

AGR: 08.200

Engine Bay Light LED



Title	PU Piece	Article No.
LED MOTORRAUMLEUCHTE	1	121806

AGR: 08.200

Spare Parts

	PU Piece	Article No.
LED RÖHRE F. BONNET LAMP	1	121807

INTERNAL/Approved (2019-03-23 00:32:51)

Basket Lamp 100W



16

Title	Performance	Cable Length	PU Piece	Article No.
CAGED LAMP 100W	100 W	5 m	1	157052

AGR: 08.200

Neon Floodlight 72W



16

INTERNAL/Approved (2019-03-23 00:33:05)

Title	Performance	Voltage	Cable Length	Height x Width x Depth	PU Piece	Article No.
WORKLAMP LOW-E C 72W DK	72 W	230 V	5 m	420 x 290 x 120 mm	1/5	115261

AGR: 08.200

Neon floodlight 38W

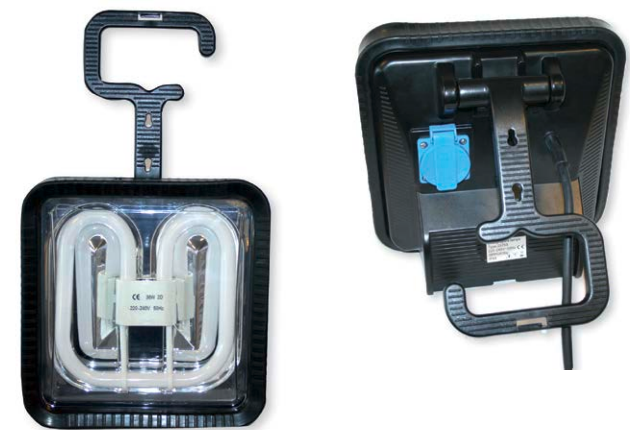

16

Title	Cable Length	PU Piece	Article No.
WORKLAMP LOW-E C 38W SCHUKO	5 m	1	115260
Spare Parts		PU Amount	Article No.
COVER GLAS FOR WORKINGLAMP 38W		1	167150

INTERNAL/Approved (2019-03-23 00:33:14)

Halogen Spotlight 400 Watt

- Foam insulated handle
- Infinitely adjustable light head using thumb screw ensures flexible deployment

Application Area

- Individual use in internal and external areas, IP 44

Characteristics

- Stable steel pipe rack, casing made of aluminum cast, temperature-resistant safety glass

Scope Of Delivery

- With appropriate halogen tube (shock resistant)

Technical Data

Cable	H 05 RN-F 3 x 1.0 mm ²
Degree Of Protection	IP54



Title	Performance	Voltage	Cable Length	PU Piece	Article No.
Halogen Spotlight	400 W	220 V	2.5 m	1	092806
AGR: 08.200					
Spare Parts				PU Piece	Article No.
Replacement Tube				1	094488

Halogen floodlight 1000W with small stand

- Foam insulated handle
- Infinitely adjustable lamp head ensures flexible deployment

Application Area

- Individual use in indoor and outdoor

Characteristics

- Sturdy tubular steel frame, cast aluminum housing, heat-resistant safety glass with protective grid

Scope Of Delivery

- With appropriate halogen tube (shock resistant)

Technical Data

Cable	H 07 RN-F 3 x 1 mm ²
Degree Of Protection	IP44



Title	Performance	Voltage	Cable Length	PU Piece	Article No.
HALOGENLAMP 1000 W	1000 W	220 V	1.5 m	1	100794
AGR: 08.200					
Spare Parts				PU Piece	Article No.
HALOGENLAMP 1000 W				1	100796

Halogen floodlight 1500W with small stand

- Infinitely adjustable lamp head ensures flexible deployment
- Foam insulated handle prevents burns and allows comfortable transport of the headlamp

Application Area

- Individual use in indoor and outdoor

Scope Of Delivery

- With appropriate halogen tube (shock resistant)

Technical Data

Cable	H 07 RN-F 3 x 1.0 mm ²
Degree Of Protection	IP 44



Title	Performance	Voltage	Cable Length	PU Piece	Article No.
HALOGENLAMP 1500 W	1500 W	220 V	1.5 m	1	100795
AGR: 08.200					
Spare Parts				PU Piece	Article No.
HALOGENLAMP 1500 W				1	100797

INTERNAL/Approved (2019-03-23 00:33:42)

Halogen floodlight 400W with mounting bracket 3 m cable

Technical Data

Cable 3 x 1.0 mm²



16

Title	Performance	Voltage	Cable Length	PU Piece	Article No.
HALOGENLAMP 400W F. STATIV	400 W	220 V	3 m	1	100792
HALOGENLAMP 2X400W F. STATIV	400 W	220 V	5 m	1	100793

AGR: 08.200

Accessories Available

	PU Piece	Article No.
Tripod stand for LED floodlight	1	144224

INTERNAL/Approved (2019-03-23 00:33:48)

Spare Parts

	PU Piece	Article No.
Replacement Tube	1	094488

Single tripod stand for LED floodlight

STANDARD*line*

Application Area

- Stand for LED spotlights and halogen lamps

Scope Of Delivery

- 3-piece stand

Technical Data

Weight	2.5 kg
Height	650 - 1600 mm
Max load capacity	10 kg

Title	PU Piece	Article No.
Tripod stand for LED floodlight	1	144224

AGR: 08.201



Tripod Projector LED 50W

- This tripod fits perfectly with the LED projector
- 50W.
- Perfectly suitable for outdoors as well as indoors.
- The double bar allows positioning of two projectors

Application Area

- Stand for LED spotlights and halogen lamps

Scope Of Delivery

- 3-piece stand

Technical Data

Weight	5 kg
Height	980 - 2000 mm
Max load capacity	30 kg

Title	PU Piece	Article No.
TRIPODHEAVY FOR LED-FLOODLIGHT	1	185722

AGR: 08.201



LED-Flooder Slim DAYlight

- Compact and robust in construction
- Powerful and uniform bright illumination which is ideal for working light
- Strong rubber protection frame
- With the flexible stand it is possible to place the lamp in the desired angle or use it as a hanger
- 70 SMD DAYlight LED lamp for color recognition
- Total aluminum design for a better heat distribution

Application Area

- The lighting in car body repair shops is often not optimal. Especially in the dark winter months, makes this deficit noticeable
- For this reason, the universal DAYlight lamp is a "must" for every repair specialist. Not only for smart repair but also for the precise determination of shades
- for workplace lighting on construction sites, factories and garages. Ideal for maintenance and the professional use
- DAYlight is perfect for any paint, polish, cleaning or prep-zone operation

Hints

- If an additional device is plugged on the LED spotlight, plug the splug into the rear power socket, therefore the prescribed safety class is achieved

Technical Data

Number of SMD LED	70 PC
Brightness main light High	2800 Lux @ 0.5 m
Max. light output	1800 lm
Degree Of Protection	IP44



Weight 2200 g



Title	Performance	Cable Length	Height x Width x Depth	PU Piece	Article No.
LED-Flooder Slim DAYlight	35 W	5 m	210 x 220 x 95 mm	1	244409

AGR: 08.201

LED-Floodlight "Black" 24 W Accu

- 72 SMD LED to deliver a light intensity of 2500 lumens.
- Powerfull and uniform illumination of the working area.
- 2 lighting modes: 100% and 50% (for longer lighting time).
- Robust body in aluminium with rubber edge guard and flexible stand.
- IP65- Resistant to water and dust infiltration for professional use.
- Charge external devices on the built in USB charging port (output).
- Intelligent discharging LED : Red >10% / Flashing green <50% / Green >50%.
- Compact, wireless easy and practice to move freely.

Application Area

- For indoor and outdoor use.

Scope Of Delivery

- Including charger with 5 m charging cable.

Technical Data

Runtime	4 h
Runtime low level	8 h
Charging Time (Standard)	5 h
Accumulator	Li-Ion, 7.4 V, 10400 mAh
Rated Voltage	230 V
Luminous flux main light High	2500 lm

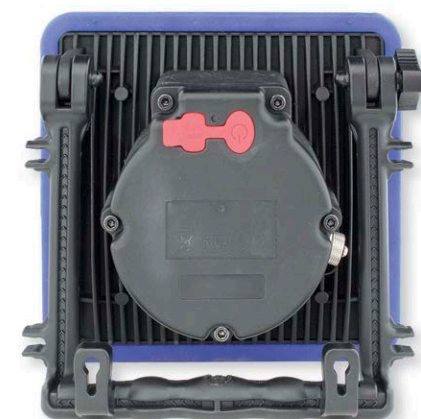

Light engineering and shiners

Luminous flux main light Low	1250 lm
Performance	24 W
Degree Of Protection	IP 65
Length x width x thickness	213 x 223 x 98 mm
Weight	2.2 kg
Colour temperature	6500 K

Title	PU Piece	Article No.
LED-Floodlight "Black" Accu	1/3/5	332543

AGR: 08.201

Scope Of Supply	Amount	Article No.
Charging cable 5 m	1	332574

Accessories Available	PU Amount	Article No.
Magnets for LED-Floodlights "Black"	1	332576

Spare Parts	PU Amount	Article No.
Replacement Bracket LED Spotlight "Black"	1	332575

LED-Floodlight "Black" 32W

- 70 SMD LED to deliver a light intensity of 3300 lumens.
- Powerful and uniform illumination of the working area.
- Robust body in aluminium with rubber edge guard and flexible stand.
- IP54-resistant to water and dust infiltration for professional use.
- Additional 230 V socket on the back to connect additional devices with a maximum power of 4000W.
- Compact, easy to transport and to install.

Application Area

- For indoor and outdoor use.

Technical Data

Brightness main light High	4000 Lux @ 0.5 m
Max. light output	3300 lm
Colour temperature	6500 K
Cable	H 05 RN-F 3 x 1.5 mm ²
Degree Of Protection	IP54
Weight	2.2 kg



Title	Performance	Voltage	Cable Length	Height x Width x Depth	PU Piece	Article No.
LED-Floodlight "Black" 32W	32 W	230 V	5 m	213 x 223 x 98 mm	1/3/5	332544

AGR: 08.201

Spare Parts

	PU Amount	Article No.
Replacement Bracket LED Spotlight "Black"	1	332575

INTERNAL/Approved (2019-03-23 00:34:42)

Magnets for LED-Floodlights "Black"

- Two strong magnet for LED-Floodlights "Black" series. Easy to update without tool directly on the bracket.

Application Area

- Allow to position the Floodlight on metal part without drilling.

Title	PU Piece	Article No.
Magnets for LED-Floodlights "Black"	1	332576

AGR: 08.201

Related Products	PU Amount	Article No.
LED-Floodlight "Black" 32W	1/3/5	332544
LED-Floodlight "Black" Accu	1/3/5	332543



LED Floodlight Charger

Technical Data

Voltage area input	100-240V AC (50-60Hz)
Length x width x thickness	72 x 84 x 52 mm
Weight	193 g

Title	Cable Length	Voltage area output	PU Piece	Article No.
LED Floodlight Charger	2 m	24 V	1	201004

AGR: 08.201



LED-Floodlight "Black" X-TREME





Title	PU Piece	Article No.
LED-Floodlight "Black" X-treme	1	340551
AGR: 08.201		
Accessories Available	PU Amount	Article No.
Doubleholder for tripod Premium	1	341418
Scaffolding mount for LED-Flooder X-treme	1	341267
Tripod Premium for LED-Flooder	1	341417

Tripod Premium for LED-Flooder

Title	PU Piece	Article No.
Tripod Premium for LED-Flooder	1	341417
AGR: 08.201		
Accessories Available	PU Amount	Article No.
Doubleholder for tripod Premium	1	341418



Doubleholder for tripod Premium

Title	PU Piece	Article No.
Doubleholder for tripod Premium	1	341418
AGR: 08.201		



INTERNAL/Approved (2019-03-23 00:34:53)

Scaffolding mount for LED-Flooder X-treme

Title	PU Piece	Article No.
Scaffolding mount for LED-Flooder X-treme AGR: 08.201	1	341267

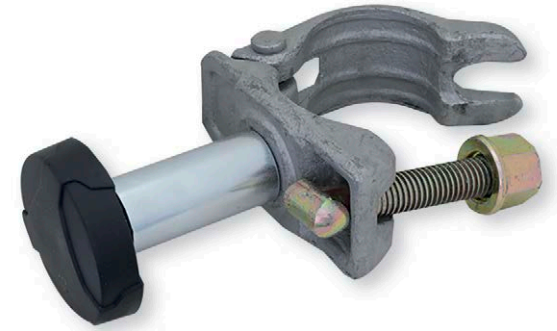

LED bulb gale 5W E14

Technical Data

Base code	E14
Type Of Lamp	LED
Bulb shape	Candle (C)
Energy class	A+
Lifetime LED	25000 h
Protection Type	IP40



Title	Performance	Light colour	Light output	Colour temperature	Light angle	PU Piece	Article No.
LED bulb gale 5W E14 CW	5 W	Cold white	450 lm	6000 K	200 °	1	332540
LED bulb gale 5W E14	5 W	Neutral white	430 lm	4000 K	200 °	1	336474
LED bulb gale 5W E14 WW	5 W	Warm white	420 lm	3000 K	200 °	1	332539

AGR: 08.200

LED bulb mini 5W E14 CW

Technical Data

Base code	E14
Type Of Lamp	LED
Bulb shape	Globe (G)
Energy class	A+
Lifetime LED	25000 h
Protection Type	IP40



Title	Performance	Light colour	Light output	Colour temperature	Light angle	PU Piece	Article No.
LED bulb mini 5W E14 CW	5 W	Cold white	450 lm	6000 K	200 °	1	332538
LED bulb mini 5W E14 W	5 W	Neutral white	430 lm	4000 K	200 °	1	336473
LED bulb mini 5W E14 WW	5 W	Warm white	420 lm	3000 K	200 °	1	336472

AGR: 08.200

LED bulb mini 5W E27 CW

Technical Data

Base code	E27
Type Of Lamp	LED
Bulb shape	Globe (G)
Energy class	A+
Lifetime LED	25000 h
Protection Type	IP40



Title	Performance	Light colour	Light output	Colour temperature	Light angle	PU Piece	Article No.
LED bulb mini 5W E27 CW	5 W	Cold white	450 lm	6000 K	200 °	1	332537
LED bulb mini 5W E27 W	5 W	Neutral white	430 lm	4000 K	200 °	1	336471
LED bulb mini 5W E27 WW	5 W	Warm white	420 lm	3000 K	200 °	1	336470

AGR: 08.200

LED lamps 6W / 9W/13W E27 Frost

Technical Data

Base code	E27
Type Of Lamp	LED
Bulb shape	Globe (G)
Energy class	A+
Lifetime LED	25000 h
Protection Type	IP40

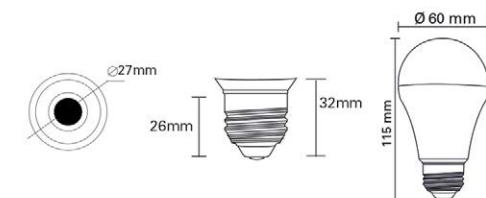

Title	Performance	Light colour	Light output	Colour temperature	Light angle	PU Piece	Article No.
LED lamps 6W E27 Frost	6 W	Cold white	500 lm	6000 K	220 °	1	242614
LED BULB 6W E27 BN	6 W	Neutral white	490 lm	4000 K	220 °	1	244004
LED BULB 6W E27 WW	6 W	Warm white	480 lm	3000 K	220 °	1	336469
LED lamps 9W E27 Frost	9 W	Cold white	820 lm	6000 K	220 °	1	242613
LED BULB 9W E27 BN	9 W	Neutral white	810 lm	4000 K	220 °	1	244003
LED BULB 9W E27 WW	9 W	Warm white	800 lm	3000 K	220 °	1	336049
LED BULB 14W E27 CW	14 W	Cold white	1400 lm	6000 K	150 °	1	332541
LED BULB 14W E27 W	14 W	Neutral white	1350 lm	4000 K	150 °	1	336467
LED BULB 14W E27 WW	14 W	Warm white	1300 lm	3000 K	150 °	1	336466

AGR: 08.200

LED Bulb 7W MR16

Technical Data

Base code	MR16
Type Of Lamp	LED
Bulb shape	Sealed beam (PAR)
Energy class	A+
Lifetime LED	25000 h
Protection Type	IP40



Title	Performance	Light colour	Light output	Colour temperature	Light angle	PU Piece	Article No.
LED BULB 7W MR16 CW	7 W	Cold white	580 lm	6000 K	100 °	1	336464
LED BULB 7W MR16 W	7 W	Neutral white	560 lm	4000 K	100 °	1	336463
LED BULB 7W MR16 WW	7 W	Warm white	550 lm	3000 K	100 °	1	336462

AGR: 08.200

LED BULB 7W GU10 WW

Technical Data

Base code	GU10
Type Of Lamp	LED
Bulb shape	Sealed beam (PAR)
Energy class	A+
Lifetime LED	25000 h
Protection Type	IP40

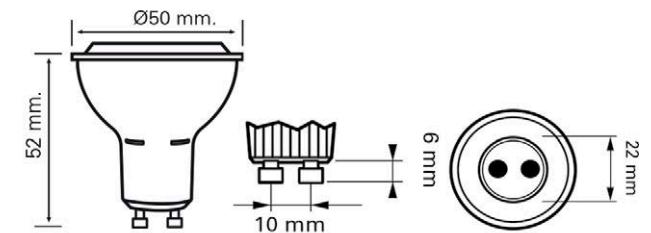

Title	Performance	Light colour	Light output	Colour temperature	Light angle	PU Piece	Article No.
LED Bulb GU10	7 W	Cold white	680 lm	6000 K	100 °	1	251496
LED bulb 7W GU10	7 W	Neutral white	660 lm	4000 K	100 °	1	336465
LED BULB 7W GU10 WW	7 W	Warm white	650 lm	3000 K	100 °	1	336051

AGR: 08.200

INTERNAL/Approved (2019-03-23 00:36:09)

Extension cable 3Gx1.5 230V orange cable



Title	Cable Type	Cable Length	PU Piece	Article No.
EXT.CABLE 230V 25M 3X2.5	XY MM-J 3 G 2,5	25 m	1	157359
EXT.CABLE 230V 10M 3X1.5	XY MM-J3G1,5 (K35)	10 m	1	157047
EXT.CABLE 230V 25M 3X1.5	XY MM-J3G1,5 (K35)	25 m	1	157358

AGR: 08.212

Extension cable 3Gx1.5 230V with tripple socket connector orange cable



Title	Cable Type	Cable Length	PU Piece	Article No.
EARTHED PL-EXT.PIPE 5M 3-F ST. AGR: 08.212	XY MM-J3G1,5 (K35)	5 m	1	159593

Extension Cable 400V CEE 16A/32A



Title	Cable Type	Cable Length	PU Piece	Article No.
EXT.CABLE 400V/25M 16A 5X1.5	XY MM-J 5 G 1,5	25 m	1	157360
EXT.CABLE 400V/10M 32A 5X4	XY MM-J 5 G 4	10 m	1	157361
EXT.CABLE 400V/25M 32A 5X4	XY MM-J 5 G 4	25 m	1	157362
EXT.CABLE 400V/10M 16A 5X1.5	XY MM-J3G1,5 (K35)	10 m	1	154019

AGR: 08.212

Machine access cable 2x1.5 5m orange cable

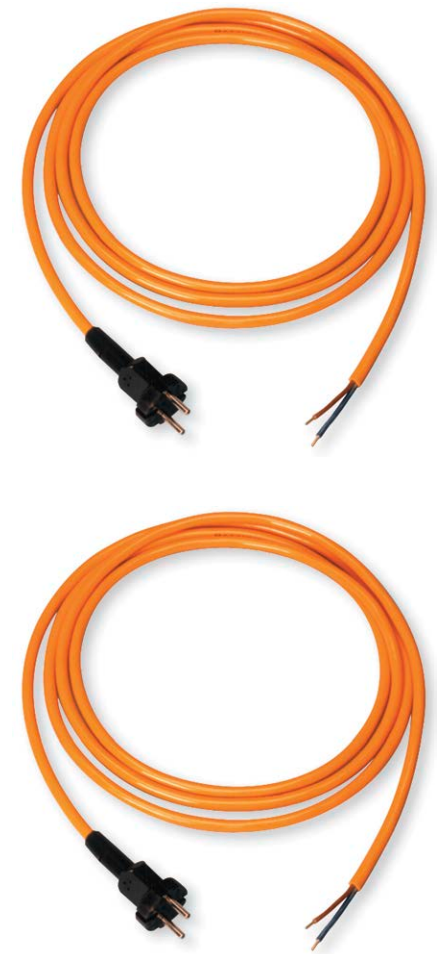

Title	Cable Length	PU Piece	Article No.
N/C CONN.LEAD 5M 2X1.5	5 m	1	157051

AGR: 08.212

INTERNAL/Approved (2019-03-23 00:36:36)

Cable ring K35 orange 50m



Title	Cable Type	Cable Length	PU Ring	Article No.
CABLE K35 YELL RING 50M 5X1.5	XY MM-J 5 G 1,5	50 m	1	157049
CABLE K35 YELL RING 50M 5X2.5	XY MM-J 5 G 2,5	50 m	1	157050
CABLE K35 YELL RING 50M 3X1.5	XY MM-J3G1,5 (K35)	50 m	1	157363
CABLE K35 YELL RING 50M 3X2.5	XY MM-J3G2,5 (K35)	50 m	1	157048

AGR: 08.212

Connector and coupling rubber 250V

Title	PU Piece	Article No.
SOL RUBB-EARTHED PL-CLU 250V	1	157061
SOL RUBB-EARTHED PLUG-SKT 250V	1	157060

AGR: 08.214



Triple coupling rubber IP44 250V

Title	PU Piece	Article No.
TRIPLE SUSPENDE COUPL RUBBER	1	159365

AGR: 08.214



INTERNAL/Approved (2019-03-23 00:36:52)

Connector, coupling, phase inverter - CEE- Model TWIST 400V

Technical Data

Color Red

Title	PU Piece	Article No.
CLUTCH CEE 5X16A 400V"TWIST"	1	157055
CLUTCH CEE 5X32A 400V"TWIST"	1	157056
PHASE INVERTER CEE 5X16A 400V	1	157057
PHASE INVERTER CEE 5X32A 400V	1	157059
PLUGS CEE 5X16A 400V "TWIST"	1	157053
PLUGS CEE 5X32A 400V "TWIST"	1	157054

AGR: 08.214



Cable drum 3Gx1.5 10m with handle

Technical Data

Protection Class	IP20
Connector Plug	Earthed socket 220 V / 16 A
Color	black / blue



Title	Cable Type	Cable Length	PU Piece	Article No.
HOUSEHOLD CABLE BOX AGR: 08.210	H 05 W-F 3 G 1,5	10 m	1/2/5	808369

Cable Drum 3Gx1.5 IP20 with steel drum and PVC cable

Technical Data

Max performance	3500 W
Performance unrolled	3500 W
Performance rolled	1100 W
Protection Class	IP20
Connector Plug	Earthed socket 220 V / 16 A
Material	Steel
Color	Silver



Title	Cable Type	Cable Length	Weight	PU Piece	Article No.
CABLE DRUMWITH PVC CABLE 25M	H 05 W-F 3 G 1,5	25 m	4.85 kg	1/2	015679
CABLE DRUM SHEET 50M	H 05 W-F 3 G 1,5	50 m	7.25 kg	1	015687

AGR: 08.210

INTERNAL/Approved (2019-03-23 00:37:09)

Cable Drum 3Gx1.5 IP20 with steel drum and rubber cable

Technical Data

Max performance	3500 W
Performance unrolled	3500 W
Performance rolled	1100 W
Protection Class	IP20
Connector Plug	Earthed socket 220 V / 16 A
Material	Steel
Color	Silver



16

Title	Cable Type	Cable Length	Weight	PU Piece	Article No.
CABLE DRUM PLAST 50M	H 05 RR-F 3 G 1,5	50 m	9.00 kg	1	808406

AGR: 08.210

Cable Drum 3Gx2.5

Technical Data

Max performance	3500 W
Performance unrolled	3500 W
Performance rolled	1100 W
Protection Class	IP 44
Connector Plug	Earthed plug 230 V / 16 A
Material	Plastic / steel
Color	Blue



Cable Drum 3Gx1.5 IP20 40m yellow cable

Technical Data

Max performance	3500 W
Performance unrolled	3500 W
Performance rolled	1100 W
Protection Class	IP 44
Connector Plug	Earthed plug 230 V / 16 A
Material	Plastic / steel
Color	Blue



16

Title	Cable Type	Cable Length	Weight	PU Piece	Article No.
SITES - CABLE DRUM 40 M	AT-N07V3V3-F3G1,5 (K35)	40 m	7.80 kg	1/2/5	121547

AGR: 08.210

Cable Drum 5Gx1.5 IP44 250/400V CEE 16A yellow cable

- Particularly stable and stable tubular steel frame
- Ergonomic handle with non-slip plastic profile
- Rotation stop switch
- Splash-proof three-phase current version Protection class IP44

Characteristics

- Robust, break-proof plastic design
- Drum size Ø 255 mm
- Plug-in parking station
- Input plug: CEE 5x 16 A, 400 V
- 2 safety sockets 250 V
- Thermal protection switch
- TÜV/GS tested
- Armoured cable (K35)
- Approved for permanent outdoor use (except in Germany)

Technical Data

Max performance	5500 W
Performance unrolled	5500 W
Performance rolled	3500 W
Protection Class	IP 44
Connector Plug	CEE 400 V / 16 A
Material	Plastic / steel
Color	Blue



Title	Cable Type	Cable Length	Weight	PU Piece	Article No.
CABLE DRUM 250/400V 16A K35	AT-NO7V3V3-F5G2,5	20 m	8.90 kg	1/2	157062

AGR: 08.210

Cable reel ECO 3x1,5 mm²

Title	PU Piece	Article No.
Cable reel ECO 3x1,5 mm ²	1	216074

AGR: 08.211

Spare Parts

Cable Stopper for 216072/74

PU
Amount

Article No.

1 336451

Cable reel Topline 3x1,5 mm² H05VV-F 16m

- Equipped with Schuko plug and socket
- Swivel bracket
- stop device
- With overheating protection
- Double earthing contacts

Characteristics

- Cable reel with spring drive, suitable as an extension cord that allows the user to always have an outlet available.

Technical Data

Cable length

15 m

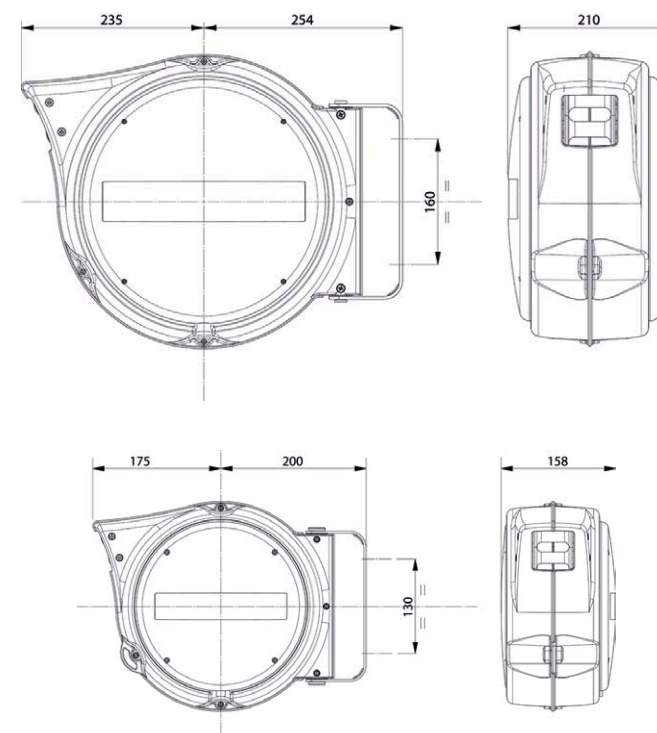

Title	Cable Type	Cable Length	Color	PU Piece	Article No.
Cable reel Topline 3x1,5 mm ² H05VV-F 16m	H 05 VV-F 3 G 1,5	15 m	black	1	216072

AGR: 08.211

Spare Parts

Cable Stopper for 216072/74

PU
Amount

Article No.

1 336451

INTERNAL/Approved (2019-03-23 00:37:47)

Cable reel Topline 3x2,5 mm² H07RN-F 16m

- Equipped with Schuko plug and socket
- Swivel bracket
- stop device
- With overheating protection
- Double earthing contacts
- quality H07RN-F cable for professional use

Characteristics

- Cable reel with spring drive, suitable as an extension cord that allows the user to always have an outlet available.

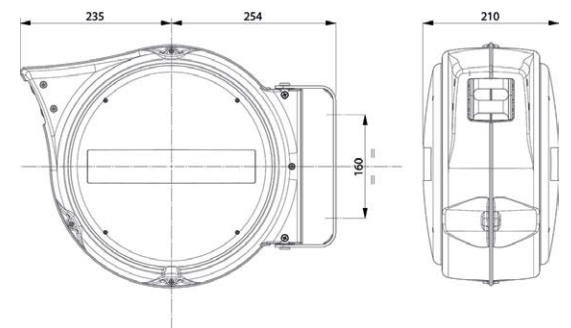

Title	PU Piece	Article No.
Cable reel Topline 3x2,5 mm ² H07RN-F 16m AGR: 08.211	1	216073
Spare Parts	PU Amount	Article No.
Cable Stopper for 216073	1	336452

INTERNAL/Approved (2019-03-23 00:37:59)

Socket outlet assemblies - Black



16

Title	Cable Type	Cable Length	PU Piece	Article No.
SOCKET DISTRIBUTOR "BLACK"	H 07 RN-F 5 G 1,5	2 m	1	896772

AGR: 08.214

Socket Distributor "Basic"



Title	PU Piece	Article No.
SOCKET DISTRIBUTOR BASIC AGR: 08.214	1	200930

"Safety" Socket Distributor

- Full rubber casing guarantees lightness, resistance against impact, corrosion and electrical safety
- Connection socket: CEE-plug 5-pole, 400 V/32 A
- Integrated sockets: 1 x 32 A CEE, 2 x 16 A CEE, 3 x Schuko 16 A
- Earth leakage protection switch 25/0.03 A

Application Area

- Use after construction current distributors on construction sites

Characteristics

- CI-protection 30 mA for the socket outlets, suitable for electric tools, which do not have a built-in GFCI
- OVE tested according to EN 60439/4

Processing Information

- With practical carrying handle



Title	PU Piece	Article No.
"Safety" Socket Distributor AGR: 08.214	1/2/5	115421

Compact Distributor - St. Anton 402

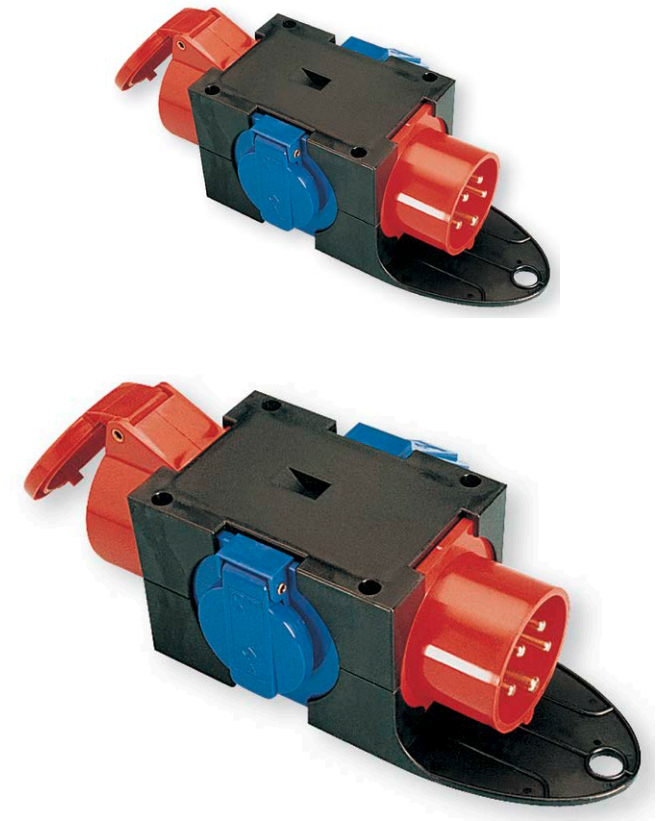

Title	Connector Plug	PU Piece	Article No.
COMPACT DISTRIB. "ST.ANTON"402	CEE 380 V / 16 A	1	157213
AGR: 08.214			

Compact Distributor - St. Anton 409

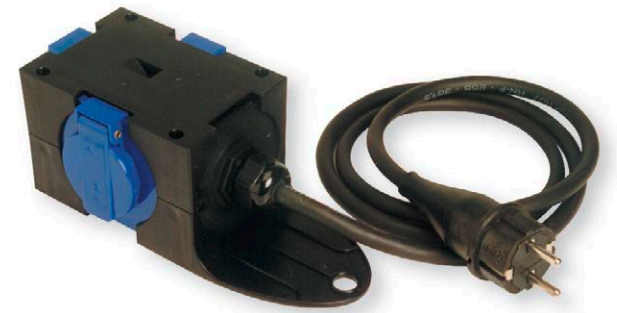
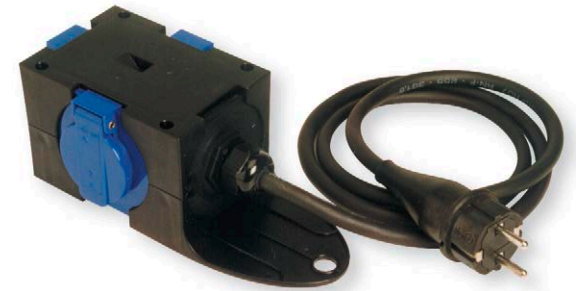

Title	Cable Type	Cable Length	PU Piece	Article No.
COMPACT DISTRIBUTOR "ST.ANTON"409 AGR: 08.214	H 07 RN-F 3 G 1,5	1.5 m	1	157214

Compact Distributor - St. Anton 411

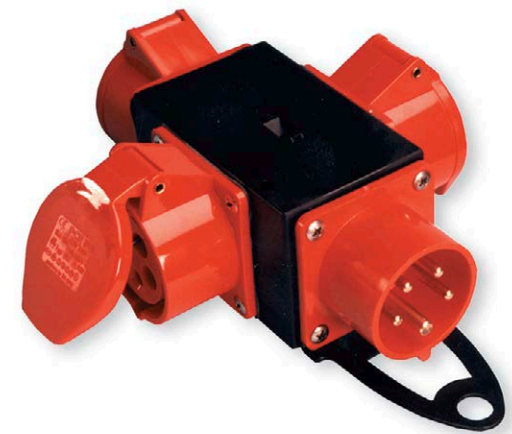
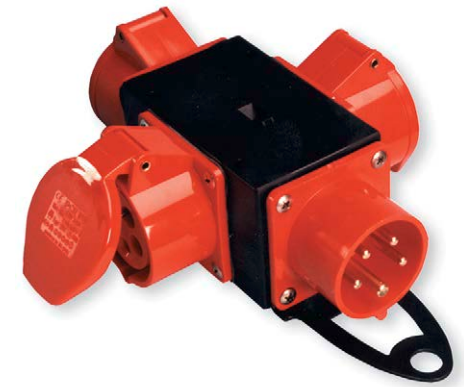

Title	Connector Plug	PU Piece	Article No.
COMPACT DISTRIB. "ST.ANTON"411 AGR: 08.214	CEE 380 V / 16 A	1	157215

Transition adaptor CEE 16A-32A

Characteristics

- Transition adaptor CEE 16A-32A

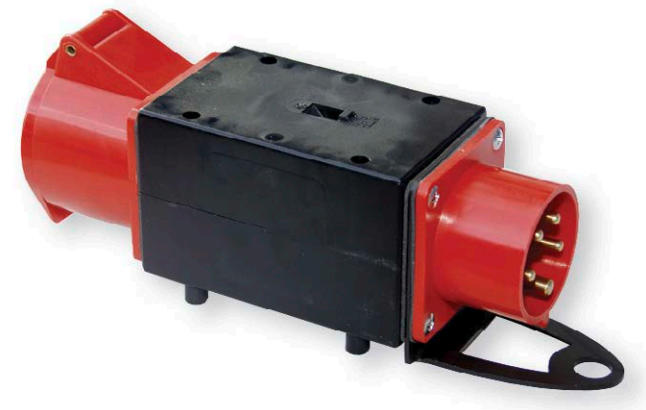

Title	Connector Plug	PU Piece	Article No.
TRANSITION PIECE 16A - 32A AGR: 08.214	CEE 380 V / 16 A	1	159367

Reduction adaptor CEE 32A-16A

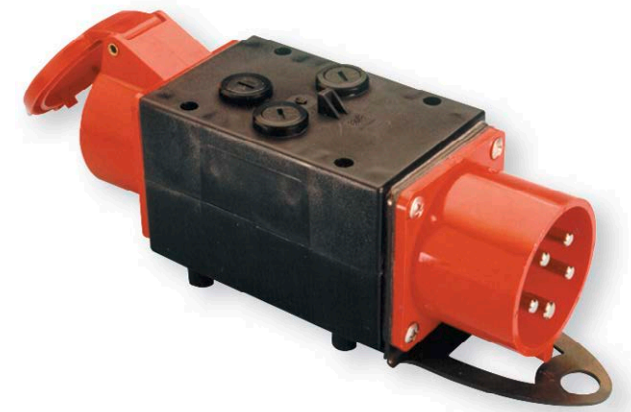

Title	Connector Plug	PU Piece	Article No.
REDUCTION 32A - 16A AGR: 08.214	CEE 400 V / 32 A	1	159368

Safety extension cable FI 1.5 m IP44



Title	Cable Type	Cable Length	PU Piece	Article No.
SAFETY EXTENSION CABLE-FI 1,5M AGR: 08.214	H 07 RN-F 3 G 1,5	1.5 m	1	198501

Multiple Socket

Technical Data

Cable colour	black	black / yellow
Rated Voltage		230 V
Protection Class	IP20	IP44
Max performance		3500 W



Title	Cable Type	Cable Length	Weight	PU Piece	Article No.
Multiple Socket	H 05 VV-F 3 G 1,5	1.4 m	0.30 kg	1	215438
Multiple Socket	H 05 VV-F 3 G 1,5	1.4 m	0.40 kg	1	215439
Multiple Socket	H 05 VV-F 3 G 1,5	1.5 m	0.43 kg	1	215440
Multiple Socket	H 07 RN-F 3 G 1,5	3.0 m	0.95 kg	1	215441

AGR: 08.214

INTERNAL/Approved (2019-03-23 00:39:05)

"Evolution" Workshop Cart

- Drawers can be pulled out completely (100%)
- Deepened perforated walls on both sides and at the rear for mounting various accessories
- Locking of the drawers prevents the unintended opening of the drawers in their closed position
- Drawer rails on ball bearings
- Central locking secures all drawers

Application Area

- The workshop cart offers excellent transportation of tools and machinery in workshops

Characteristics

- 2 lockable steering castors
- stable tube push handle and rippled rubber surface (not mounted when delivered)
- for delivery purposes all wheels are mounted
- individual drawers can be locked – unlockable via a click rail

Processing Information

- Can be fitted with suitable plastic inserts for tools
- Can be fitted with BERA sets

Scope Of Delivery

- Partition sheets (x 10) for establishing drawer compartments as well as 1 storage compartment





Title	Color	Height x width x depth	Height, External	PU Piece	Article No.
TROLLEY, EVO03 ANTHRA, RAL7016	Anthracite	880 x 700 x 470 mm	880 mm	1	216432
WORKSHPTROLL. EVOLUTION3-BLUE	Blue	880 x 700 x 470 mm	-	1	164364
WORKSHPTROLL.EVOLUTION3-GREEN	Green	880 x 700 x 470 mm	880 mm	1	047799
MOBILE WORKSHOP EVO. 7035 GREY	Grey	880 x 700 x 470 mm	880 mm	1	003120
Workshop trolley „Evolution“ 3 red RAL 3020	Red	880 x 700 x 470 mm	-	1	164363
TROLLEY, EVO03 YELLOW, RAL1016	Yellow	880 x 700 x 470 mm	880 mm	1	216433

AGR: 08.100

Accessories Available

	PU Piece	Article No.
Telescope Rail Pair, Ball Beared as of 04/07	1	045106
Replacement lock	1	013411
Fixed castor	1	149301
Steering castor	1	149300

Workshop Trolley Evolution Blue

Technical Data

Weight

59 kg

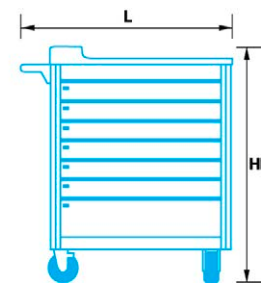
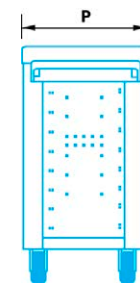



Title	Color	External Width	Height, External	Depth, Exterior	PU Piece	Article No.
TROLLEY EVOLUTION ANTH. F	Anthracite	700 mm	885 mm	475 mm	1	219191
TROLLEY EVOLUTION GREEN F	Green	700 mm	885 mm	475 mm	1	219192
TROLLEY EVOLUTION YELLOW F	Yellow	700 mm	885 mm	475 mm	1	219194
WKSHOP TROLL EVOLUTION BLUE F	Blue	700 mm	885 mm	475 mm	1	157609
WKSHOP TROLL EVOLUTION RED F	Red	700 mm	885 mm	475 mm	1	157610
Workshop Trolley Evolution Grey	Grey	700 mm	885 mm	475 mm	1	185733

AGR: 08.100

Accessories Available

	PU Piece	Article No.
Paper container	1	148977
Cleaning cloth holder	1	148979
Chemicals Can Holder	1	148978
Partition sheet 50 mm	10	149245
Telescope Rail Pair, Ball Beared as of 04/07	1	045106
Partition sheet 100 mm	5	149246
Plastic cover	1	148975
Ergonomic handle	1	148976
Holder 6/60 for machines and pipes	1	198960
Steering castor	1	149300
Fixed castor	1	149301
WOOD WORKINGPLATE EVO03	1	216435
DRAWER SEPERATOR EVO03, BLACK	1	216436
Replacement lock	1	013411
DRAWERS LOCK SET	1	245101
TRAY 75MM FOR EVO "NEW"	1	043496

INTERNAL/Approved (2019-03-23 00:39:31)

Workshop Trolley Revolution

- Enormous provision of space due to space outer dimensions of 1075 x 955 x 540 mm resp. drawer inner dimensions of 688 x 398 mm. Product provides large amount of space for your tools.
- Extra large working area (850 x 535 mm) with 10 round hole recesses (Ø 17 mm) and a long hole recess (100 x 17 mm) for the storage of screwdrivers, extensions etc.
- Can be locked and thus secures your tools against robbery
- Central lock with folding key (reduces risk of injury) as well as spare key
- Side walls and back wall complete with square hole grid
- For the inclusion of tool hooks and attachments for individual configuration
- Possible dynamic total load up to 600 kg distributed on the base plate
- Back-friendly working height of 1.08 m
- Plastic parts have high impact resistance, very good scratch resistance and excellent chemical resistance (e.g. against oils, benzene, thinner, brake fluid) for a long service life
- Surrounding impact protection both above and below prevents damage due to bumps
- Ball beared, easy running wheels (2 steering wheels with brakes and 2 stiff wheels)
- Soft touch handle made of 2 component material, maximum loadability when pulled, pressure and when pressure is applied and with impact
- Ball beared drawer telescope extendable by 100% and with individual locking, thus no unwanted opening, e.g. during operation
- Absolute resistance to tilting due to anti-tilt block on both sides of the drawers, only one drawer can be moved out each time
- Loading capacity per drawer 35 kg
- Dirt protected, replaceable labelling ledges for quick content overview of the drawers
- Accessories : Separating sheets enable individual drawer arrangement



Workshop trolleys

- Individual color selection of the casing in blue (RAL 5002), red (RAL 3020) and silver-gray (9006) with a selection of 7 or 8 drawers. With purchase quantities from 5 trolleys also available in the colors blue (RAL 5003), yellow (RAL 1033), green (RAL 6007) and gray (RAL 7035) (note on additional color costs)
- 5 year guarantee (wearing parts as well as inappropriate operation excluded)
- Comprehensive tool inlets, small part inlets, add-on parts and equipment program



Title	Color	External Width	Height, External	Depth, Exterior	Number of drawers	PU Piece	Article No.
GARAGE TROLLY REVOLUTION 8BLUE	Blue	955 mm	1075 mm	540 mm	8	1	034223
GARAGE TROLLY REVOLUTION 8 RED	Red	955 mm	1075 mm	540 mm	8	1	034224
GARAGE TROLLY REVOLUTION 8SI	Silver grey	955 mm	1075 mm	540 mm	8	1	034225

AGR: 08.100

Spare Parts

	PU Amount	Article No.
Drawer Rail Pair	1	039030

INTERNAL/Approved (2019-03-23 00:39:44)

Revolution Top-Mounted /Tool Cabinet

- Enormous space provision with outer dimensions of 360 x 830 mm drawer inner dimensions of 688 x 398 mm it provides a large amount of space for your tools
- Lockable thus secures your tools against robbery. Lock with folding (reduces the risk of injury) as well as spare key
- Side walls and back wall completely with square hole grid for the inclusion of tool hooks and add-on pieces for individual configuration
- Plastic parts provide high impact resistance, very good scratch resistance and excellent chemical resistance (e.g. against oils, benzine, solvents, brake fluids) for a long service life beared drawer telescope extendable by 100% and with individual locking per drawer, thus no unwanted opening, e.g. during drive
- Absolute resistance to tilting due to anti-tilt block on both sides of the drawers, only one drawer can be moved out each time
- Loading capacity per drawer 35 kg
- Dirt protected, replaceable labelling ledges for quick content overview of the drawers
- Accessories: Separating sheets enable individual drawer arrangement
- Comprehensive tool inlets, small part inlets, add-on parts and equipment program



Application Area

- Can be used as a top-mounted cabinet for the Revolution workshop trolley or as a separate tool cabinet

Scope Of Delivery

- 2 carrying handles
- Rippled rubber surface
- Screwing set for workshop cart "Revolution"

Title	External Width	Height, External	Depth, Exterior	PU Piece	Article No.
Revolution Top-Mounted /Tool Cabinet blue	830 mm	360 mm	530 mm	1	046624

AGR: 08.100

Replacement Parts for Revolution Workshop Cart

Hints

- Lateral divider U-Profile for optimal fixation of tool inlets

Title	PU Amount	Article No.
Central Lock with Key	1	039031
Drawer Rail Pair	1	039030
Length divider	1	039036

AGR: 08.100



Workshop trolley "Revolution", extension parts

Application Area

- For machines and pipes

Characteristics

- Suitable as tray or writing board, has the ability to swivel

Hints

- Includes mounting material and adapter for attachment to the Evolution workshop cart

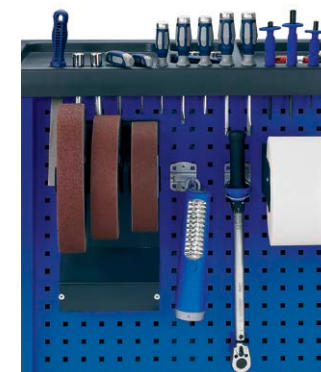

Workshop trolleys



Title	External Width	Height, External	Depth, Exterior	PU Piece	Article No.
Windscreen holder set (4-part)	-	-	-	1	037570*
Holder 6/60	100 mm	750 mm	60 mm	1	198960
Multiplex wooden worktop	225 mm	405 mm	25 mm	1	037549
Multiplex Large Wooden Worktop	305 mm	405 mm	25 mm	1	051247
Table	450 mm	288 mm	250 mm	1	051249*
Empty tool/system box wall	808 mm	-	494 mm	1	037571

* = The delivery time is 30 days

AGR: 07.110 / 08.100

Tool Box for Workshop Trolley „Evolution“

- Drawers can be pulled out completely (100%)
- Deepened perforated walls on the side and on the back wall for the attachment of several equipment parts
- Locking of the drawers arrest prevents unintended opening of the drawers in their closed position
- Drawer rails on ball bearings
- Central locking secures all drawers
- Optimal for an enhancement of the workshop cart through 3 more drawers

Characteristics

- Individual drawers can be locked- unlockable via a click rail

Processing Information

- Can be fitted with suitable plastic inlets for tools
- Can be fitted with Bera sets

Scope Of Delivery

- Includes dividers for drawer dividers and a storage compartment
- Supplied with plastic cover

Technical Data

Weight 20 kg



Title	Color	External Width	Height, External	Depth, Exterior	PU Piece	Article No.
Tool Box for Workshop Cart Evolution	Blue	700 mm	410 mm	470 mm	1	010156
Tool Box for Workshop Cart Evolution	Red	700 mm	410 mm	470 mm	1	010953

AGR: 08.100

Plastic cover for "Evolution"

Characteristics

- Made from ABS, color black, with numerous options for storing small parts, tools and chemicals spray cans

Title	PU Piece	Article No.
Plastic cover	1	148975

AGR: 08.100



Wood working plate for "Evolution"



Title	External Width	Height, External	Depth, Exterior	PU Piece	Article No.
WOOD WORKINGPLATE EVO03	735 mm	25 mm	510 mm	1	216435

AGR: 08.100

Ergonomic handle for "Evolution"

Characteristics

- With supports for screwdrivers and 1 cavity for small parts, color anthracite

Title	PU Piece	Article No.
Ergonomic handle	1	148976

AGR: 08.100



Seperator for drawer "Evolution"

- More storage capacity
- Better Management from tools or smal parts in the drawer
- Powder coating

Application Area

- Seperator for lower drawer from the "Evolution"

Scope Of Delivery

- 3 seperator blades L 192 x H 60 mm



16

Title	Color	External Width	Height, External	Depth, Exterior	Subjects, Number	PU Piece	Article No.
DRAWER SEPERATOR EVO03, BLACK	Anthracite	565 mm	75 mm	195 mm	6 PC	1	216436

AGR: 08.100

Accessories and replacement parts for the "Evolution" workshop cart

Title	PU Piece	Article No.
Replacement lock	1	013411
Fixed castor	1	149301
Partition sheet 100 mm	5	149246
Partition sheet 50 mm	10	149245
Steering castor	1	149300
Telescope Rail Pair, Ball Beared as of 04/07	1	045106
TRAY 75MM FOR EVO "NEW"	1	043496

AGR: 08.100



Small Storage Compartment for Evolution and Revolution

Characteristics

- Color anthracite

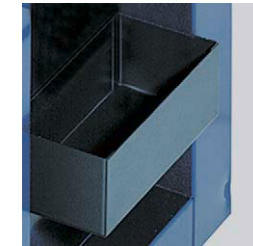

Title	PU Piece	Article No.
STORE TRAY, SM, F.WORKSH T EVO	1	157336

AGR: 08.100

Workshop trolley "Revolution", extension parts

Characteristics

- Color anthracite, 302 x 302 x 150 mm



Title	External Width	Height, External	Depth, Exterior	PU Piece	Article No.
Paper container	300 mm	310 mm	200 mm	1	148977

AGR: 08.100

Chemical Can Holder for Evolution and Revolution

Characteristics

- With carrying handle, for storing 8 spray cans, color anthracite



Title	External Width	Height, External	Depth, Exterior	PU Piece	Article No.
Chemical Can Holder	300 mm	100 mm	160 mm	1	148978

AGR: 08.100

Cleaning Cloth Holder for Evolution and Revolution

Characteristics

- For storing a cleaning cloth roll, color anthracite

Hints

- Max. Cleaning cloth holder width 29 cm



Title	External Width	Height, External	Depth, Exterior	PU Piece	Article No.
Cleaning cloth holder	325 mm	150 mm	230 mm	1	148979

AGR: 08.100

INTERNAL/Approved (2019-03-23 00:41:18)

PA

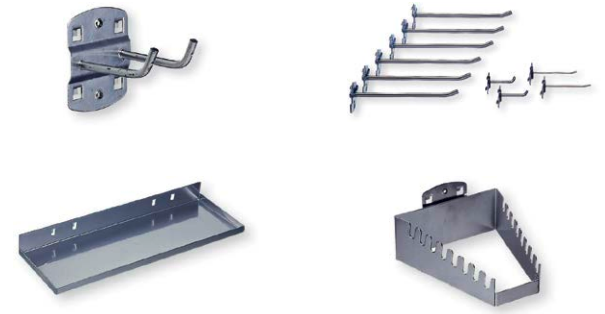

Socket Wrench Set 1/2", 25-piece in SMART-Box

- Socket wrench set with Berner Flank Drive (BFD) for a considerably greater contact area with the screw connection

Characteristics

- Ratchet wrench with 72 teeth, fine-toothed

Scope Of Delivery

- 20 hex sockets: wrench size 10 - 11 - 12 - 13 - 14 - 15 - 16 - 17 - 18 - 19 - 20 - 21 - 22 - 23 - 24 - 26 - 27 - 28 - 30 - 32 mm
- 1 lever ratchet wrench
- 1 T-handle
- 1 x extension bar 125 and 250 mm
- 1 universal joint
- The storage and transport case, the "SMART-BOX size 2" incl. a removable plastic insert, suitable for Berner workshop trolley systems



Title	Drive	PU Piece	Article No.
Socket-Set 1/2" 6-point BFD, 25 pieces	1/2" / 6KT	1	039890

AGR: 03.018

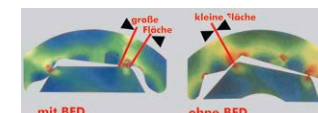

Ratchet Ring Wrench Set with L-Socket Profile

- Ratchet, extension bar and socket wrench inserts with a through-hole, which also makes it suitable for stay bolt fittings
- L-socket profile, supports 46 applications on up to 4 profiles (hex, 12-sided, inch and TX) with only 14 socket wrench inserts
- Ideal for working in narrow spaces because of its low design height
- Can also be used with conventional socket wrench inserts 1/4" or 1/2" adapter

Scope Of Delivery

- 1 x Loop-Ratchet-Inlay: SW 8 - 9 - 10 - 11 - 12 - 13 - 14 - 15 - 16 - 17 - 18 - 19 - 21 - 22 mm
- 1x Loop-Ratchet reconnecting-gun
- 1x extension 75 mm, 150 mm
- 1x 1/4" bit socket
- 1x 10mm bit socket
- 1x adapter 1/2" wrench socket
- 1x adapter 1/4" wrench socket
- 1x Bit 10mm: TX 20-TX25, TX 27, TX 30, TX 40, TX 45, TX 50, TX 55
- Je 1x Bit 10mm: multi-toothed M 5, M 6, M 8, M 10, M 12
- Je 1xbit 10mm: allen M 5, M 6, M 7, M 8, M 10, M 12

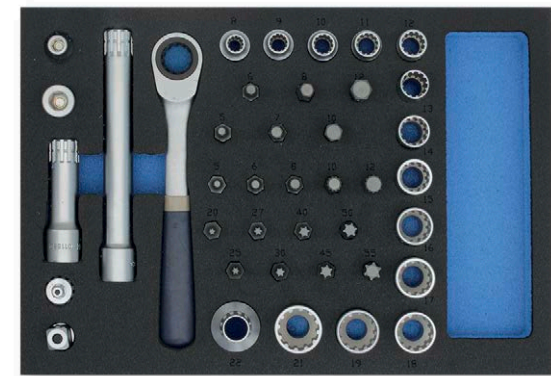

Title	PU Piece	Article No.
Ratchet ring wrench set, 40-piece	1	048374

AGR: 03.018

Scope Of Supply	Piece	Article No.
Ratchet LoopRatchet-Set	1	011590
Ratchet ring Wrench Insert 8 mm	1	011548
Ratchet ring Wrench Insert 9 mm	1	011549
Ratchet ring Wrench Insert 10 mm	1	011550
Ratchet ring Wrench Insert 11 mm	1	011551
Ratchet ring Wrench Insert 12 mm	1	011554
Ratchet ring Wrench Insert 13 mm	1	011558
Ratchet ring Wrench Insert 14 mm	1	011559
Ratchet ring Wrench Insert 15 mm	1	011573
Ratchet ring Wrench Insert 16 mm	1	011574

Scope Of Supply	Piece	Article No.
Ratchet ring Wrench Insert 17 mm	1	011575
Ratchet ring Wrench Insert 18 mm	1	011577
Ratchet ring Wrench Insert 19 mm	1	011579
Ratchet ring Wrench Insert 21 mm	1	011580
Ratchet ring Wrench Insert 22 mm	1	011581
Hex Bit, 10 mm, AF 5mm, length 30mm	1	000897
Hex Bit, 10 mm, AF 6mm, length 30mm	1	000896
Hex Bit, 10 mm, AF 7mm, length 30mm	1	000895
Hex Bit, 10 mm, AF 8mm, length 30mm	1	000894
Hex Bit, 10 mm, AF 10mm, length 30mm	1	000899
Hex Bit, 10 mm, AF 12mm, length 30mm	1	000898
Bit TX 20 30 mm	1	000890
Bit TX 25 30 mm	1	000888
Bit TX 30 30 mm	1	000886
Bit TX 40 30 mm	1	000884
Bit TX 45 30 mm	1	000882
Bit TX 50 30 mm	1	000879
Bit TX 55 30 mm	1	000877
Bit XZN 5 30 mm	1	000867
Bit XZN 6 30 mm	1	000866
Bit XZN 8 30 mm	1	000864
Bit XZN 10 30 mm	1	000872
Bit XZN 12 30 mm	1	000869
Ratchet ring wrench Extension Bar 75 mm	1	011582
Ratchet ring wrench Extension Bar 150 mm	1	011583
Ratchet ring wrench Adapter 1/4" Socket Wrench Insert	1	011592
Ratchet ring wrench Adapter 1/4" Bit	1	011594
Ratchet ring wrench Adapter 1/2" Socket Wrench Insert	1	011593
Ratchet ring wrench Adapter 10 mm Bit	1	011595
Bit 10 TX27 30 mm	1	-

INTERNAL/Approved (2019-03-23 00:42:00)

Plastic inlay with 3 component pliers set universal

Title	Height x width x depth	PU Piece	Article No.
3K LINING WITH PLIERS SET AGR: 03.209	51 x 228 x 337 mm	1	129054

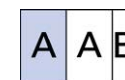

Hard foam inlay with socket driver set 1/4" inclusive lever ratchet 60 T

Scope Of Delivery

- Each 1 x Socket Wrench 1/4 "SW 4 - 4.5 - 5 - 5.5 - 6 - 7 - 8 - 9 - 10 - 11 - 12 - 13 mm
- 1 x Lever Ratchet 60 T
- 1 x Bit Adapter
- 1 x Hand wrench with 1/4 ", 4 octagonal
- 1 x T-Sliding T
- 2 x extensions 55 and 100 mm
- 1 x universal joint
- Each 1 x Bit 1/4 " Phillips size 1, 2, 3; longitudinal slit 4,5- 5,5 - 6,5 mm; SW 3 - 4 - 5 - 6 - 8 mm, TX 15, TX 20, TX 25, TX 30



Title	Outside dimension W x H x D	PU Piece	Article No.
S-SET LEVER BFD 1/4" HS 60T	110 x 33 x 337 mm	1	213269

AGR: 03.701

Scope Of Supply

	Amount	Article No.
FOAM LEVER BFD 1/4" 60T	1	210764

Hard Foam Inlet with 1/4" Socket Wrench Set incl. Flex Ratchet Handle

Scope Of Delivery

- 1 x 1/4" socket wrench insert in each of the wrench sizes WS 4 - 4.5 - 5 - 5.5 - 6 - 7 - 8 - 9 - 10 - 11 - 12 - 13 mm
- 1 x Lever flex ratchet handle, fine toothed
- 1 x Bit-Adapter
- 1 x Handheld screwdriver with 1/4", square
- 1 x T-shaped sliding handle
- 2 x Extensions 55 and 100 mm
- 1 x Cardan Joint
- 1 x 1/4" screwdriver insert:: Phillips-type size 1, 2, 3
- longitudinal slit 4 - 6 - 7 mm
- allen key in each of the wrench sizes 3 - 4 - 5 - 6 - 8 mm
- TX 15, TX 20, TX 25, TX 30

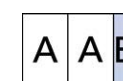

INTERNAL/Approved (2019-03-23 00:42:36)

Workshop trolleys

Title	Outside dimension W x H x D	PU Assortment	Article No.
FOAMLINING+SOCKET-SET 1/4"	110 x 33 x 337 mm	1	034579

AGR: 03.701

Hard foam inlay with I-Socket 1/4 " inclusive lever ratchet 60 T

Scope Of Delivery

- Each 1 x Socket 1/4 ", SW 4 - 4.5 - 5 - 5.5 - 6 - 7 - 8 - 9 - 10 - 11 - 12 - 13 - 14 mm
- 1 x Lever ratchet 60 T
- 1 x Hand Held Devices
- 1 x 50 mm and 1 x 100 mm extension
- 1 x T-Sliding T
- 1 x universal joint



16

Title	Outside dimension W x H x D	PU Piece	Article No.
S-SET LEVER I SOC. 1/4" HS 60T	110 x 33 x 337 mm	1	213266

AGR: 03.701

Scope Of Supply

	Amount	Article No.
FOAM LEVER I SOCKET 1/4" 60T	1	210766

INTERNAL/Approved (2019-03-23 00:43:01)

Hard Foam Inlet with 1/4" I-Socket incl. Flex Ratchet Handle

Scope Of Delivery

- 1 x 1/4" socket wrench insert in each of the wrench sizes WS 4 - 4.5 - 5 - 5.5 - 6 - 7 - 8 - 9 - 10 - 11 - 12 - 13 - 14 mm
- 1 x flex ratchet handle, fine toothed
- 1 x Hand Screwdrivers
- 2 x Extensions 50 and 100 mm
- 1 x T-shaped sliding handle

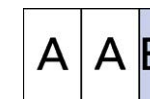
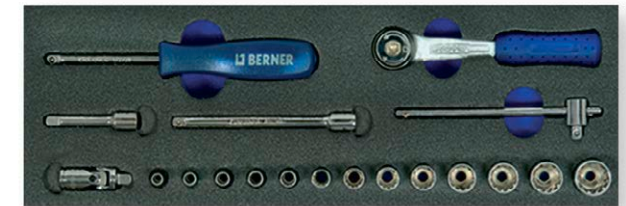

Title	Outside dimension W x H x D	PU Assortment	Article No.
Hard Foam 1/4" Inlet I-Socket AGR: 03.701	110 x 33 x 337 mm	1	039694

socket driver set 1/4" + 3/8", 54 parts, 60 T

Scope Of Delivery

- 1/4":
- 12 hex socket wrench inserts: SW 4 - 4,5 - 5 - 5,5 - 6 - 7 - 8 - 9 - 10 - 11 - 12 - 13 mm
- 15 screwdriver inserts: inner hex wrench size AF 3 - 4 - 5 - 6 - 8 mm; TX: T 15, T 20, T 25, T 30; crosshead PH 1, PH 2, PH 3; longitudinal slot 0,6 x 4,5, 0,8 x 5,5, 1,2 x 6,5 mm
- 1 Lever ratchet wrench 60 T
- 1 bit adapter
- 2 extension bars 55 and 100 mm
- 1 sliding T-handle
- 3/8":
- 17 hex socket wrench inserts: AF 6 - 7 - 8 - 9 - 10 - 11 - 12 - 13 - 14 - 15 - 16 - 17 - 18 - 19 - 20 - 21 - 22
- 1 Lever ratchet wrench
- 1 sliding T-handle



INTERNAL/Approved (2019-03-23 00:43:26)

Workshop trolleys

- 2 extension bars 125 and 250 mm
- 1 Universal joint
- The storage and transport case, the "SMART-BOX size 2"
- including a removable plastic insert, suitable for Berner
- workshop trolley systems



Title	Height, External	Depth, Exterior	External Width	PU Piece	Article No.
S-SET LEVER BFD 1/4"3/8"HS 60T	33 mm	337 mm	228 mm	1	213270
AGR: 03.701					
Scope Of Supply				Amount	Article No.
FOAM LEVER BFD 1/4" 3/8" 60T				1	210768

Foam Inlay with Bit Sockets 1/4"

Scope Of Delivery

- 1/4" Bit Sockets:
- Slot - 4.0, 5.5, 6.5, 8.0, 10.0 mm
- PH - 1, 2, 3, 4
- PZ - 1, 2, 3
- HEX - 3, 4, 5, 6, 7, 8, 10 mm
- Torx - T8, T9, T10, T15, T20, T25, T27, T30, T40
- R-Torx - RT8, RT9, RT10, RT15, RT20, RT25, RT27, RT30
- 5-Star - TS10, TS15, TS20, TS25, TS27, TS30, TS40
- 1/4" Handle



Title	PU Piece	Article No.
Foam Inlay with Bit Sockets 1/4"	1	336382
AGR: 03.701		

Hard Foam Inlet with 1/4" Bit- and Socket Wrench Inserts (60 units)



Hints

- Can be used in the front or in the back of the drawer in the workshop trolley Revolution

Scope Of Delivery

- 1 x 1/4" socket wrench insert:
- socket wrench: 3 - 4 - 5 - 6 mm
- LS: 4 - 5.5 - 6.5 - 7 mm
- PH + PZ: 1 - 2 - 3
- Inner-TX: 8 - 9 - 10 - 15 - 20 - 25 - 27 - 30 mm
- R-TX: 8 - 9 - 10 - 15 - 20 - 25 - 27 - 30 mm
- 1 x bit 10 mm
- socket wrench: 7 - 8 - 9 - 10 - 12 - 14 mm
- LS: 8 - 10 - 12 mm
- PH: 2 - 3- 4
- TX: 20 - 25 - 27 - 30 - 35 - 40 - 45 - 50 - 55 - 60 mm
- Multi teeth XZN: 5 - 6 - 8 - 9 - 10 - 12
- 1 x 1/2"adapter on 10 mm bit
- 1 x adapter for ratchet ring wrench on 10 mm bit

Title	Height x width x depth	Outside dimension W x H x D	PU Assortment	Article No.
FOAM INLETT + 10MM U. 1/4" SET	33 x 682 x 59 mm	682 x 33 x 59 mm	1	076346

AGR: 03.701

INTERNAL/Approved (2019-03-23 00:43:50)

Hard foam inlay with socket driver set 3/8" inclusive lever ratchet 60 T

Scope Of Delivery

- Each 1 x Socket 3/8 ", SW 6 - 7 - 8 - 9 - 10 - 11 - 12 - 13 - 14 - 15 - 16 - 17 - 18 - 19 - 20 - 21 - 22 mm
- 1 x Reversible
- 1 x T-Sliding T
- 1 x extension 125 mm and 1 x 250 mm
- 1 x universal joint
- 1 x Lever ratchet 60 T



Title	Outside dimension W x H x D	PU Piece	Article No.
S-SET LEVER BFD 3/8"HS 60T	228 x 33 x 337 mm	1	213271
AGR: 03.701			
Scope Of Supply		Amount	Article No.
FOAM LEVER BFD 3/8" 60T		1	210765

16

Hard Foam Inlet with 3/8" Socket Wrench Set incl. Flex Ratchet Handle

Scope Of Delivery

- 1 x 3/8" socket wrench insert in each of the wrench sizes WS 6 - 7 - 8 - 9 - 10 - 11 - 12 - 13 - 14 - 15 - 16 - 17 - 18 - 19 - 20 - 21 - 22 mm
- 1 x Flex ratchet handle, fine toothed
- 1 x T-shaped sliding handle
- 2 x Extensions 125 and 250 mm
- 1 x Cardan Joint



Title	Outside dimension W x H x D	PU Assortment	Article No.
Hard foam insert with 3/8" socket wrench set	228 x 33 x 337 mm	1	034578

AGR: 03.701

Foam Inlay with 3/8" Socket Bit TX, Hex and Sockets deep 6-point

Scope Of Delivery

- 3/8" Socket Bit:
- Hex - 3, 4, 5, 6, 7, 8, 9, 10, 12 mm
- TX - T15, T20, T25, T27, T30, T40, T45, T50
- Socket deep 6-point - 7, 8, 9, 10, 11, 12, 13, 14, 15, 16, 17, 18, 19, 20, 21, 22 mm

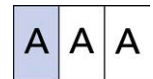
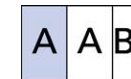
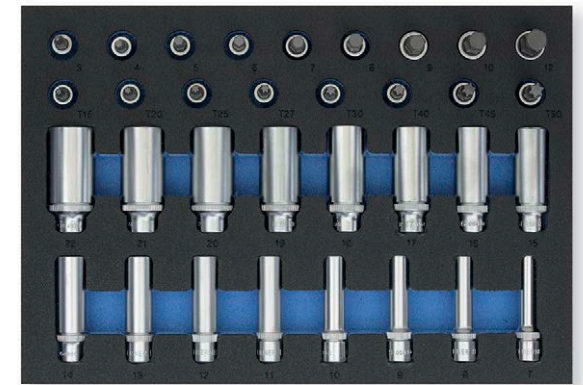

Title	PU Piece	Article No.
3/8"Socket deep / Socket Bit TX, Hex	1	336381

AGR: 03.701

Hard foam inlay with socket driver set 1/2" inclusive lever ratchet 60 T

Scope Of Delivery

- Each 1 x Socket 1/2 ", SW 10 - 11 - 12 - 13 - 14 - 15 - 16 - 17 - 18 - 19 - 20 - 21 - 22 - 23 - 24 - 26 - 27 - 28 - 30 - 32 mm
- 1 x lever ratchet 60 T
- 1 x T-Sliding T
- 2 x extensions 125 and 250 mm
- 1 x universal joint



Title	Outside dimension W x H x D	PU Piece	Article No.
S-SET LEVER BFD 1/2" HS 60T	228 x 33 x 337 mm	1	213273
AGR: 03.701			
Scope Of Supply		Amount	Article No.
FOAM LEVER BFD 1/2" 60T		1	210769

Hard foam inlay socket driver set 1/4" and 1/2" inclusive lever ratchet 60 T

Scope Of Delivery

- Sockets 1/4 ":
- 12 Sockets 6-kant:
- SW 4 to 4.5 - 5 to 5.5 - 6 - 7 - 8 - 9 - 10 - 11 - 12 - 13 mm
- 15 Screwdriver Bits:
- Allen: SW 3 - 4 - 5 - 6 - 8 mm
- TX: T 15 - T 20 - T 25 - T 30
- Phillips: PH1 - PH2 - PH 3
- Longitudinal slit: 0.6 x 4.5 to 0.8 x 5.5 to 1.2 x 6.5 mm
- 1 reversible ratchet
- 1 bit adapter
- 2 extensions 55 and 100 mm
- 1 universal joint
- Sockets 1/2 ":
- 17 Sockets 6-kant:
- SW 10 - 11 - 12 - 13 - 14 - 15-16 - 17 - 18 - 19 - 20 - 21 - 22 - 24 - 27 - 30 - 32 mm
- 1 reversible ratchet
- 1 T-Sliding T
- 2 extensions 125 mm and 250 mm
- 1 universal joint

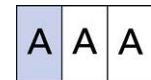
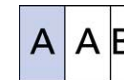

Title	Outside dimension W x H x D	PU Piece	Article No.
S-SET LEVER BFD 1/4"1/2"HS 60T	228 x 33 x 337 mm	1	213272
Scope Of Supply		Amount	Article No.
FOAM LEVER BFD 1/4" 1/2" 60T		1	210772

INTERNAL/Approved (2019-03-23 00:44:30)

Hard Foam Inlet with 1/2" Socket Wrench Set incl. Flex Ratchet Handle

Scope Of Delivery

- 1 x 1/2" socket wrench insert in each of the wrench sizes WS 10 - 11 - 12 - 13 - 14 - 15 - 16 - 17 - 18 - 19 - 20 - 21 - 22 - 23 - 24 - 26 - 27 - 28 - 30 - 32 mm
- 1 x Flex ratchet handle, fine toothed
- 1 x T-shaped sliding handle
- 2 x Extensions 125 and 250 mm
- 1 x Cardan Joint

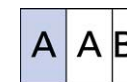

Title	Outside dimension W x H x D	PU Assortment	Article No.
FOAMLINING+SOCKET-SET 1/2" AGR: 03.701	228 x 33 x 337 mm	1	034577

Hard Foam Inlet with Socket Tool Set, 151-pcs., Lever ratchet 60 T

Scope Of Delivery

- Sockets: 1/4 ": 12 x BFD, 7 x BFD deep, 5 x for internal TX screws, 4 x Indoor 6-head screws, 4 x longitudinal slot, 3 x Phillips PH 3 x cross drive PZ, 8 x screws with TX, 8 x with TX-head screw hole
- Each 1 x Extension 1/4 "50 mm extension 1/4" 100 mm, T-Sliding T 1/4 "universal joint 1/4" hand wrench 1/4 "ratchet handle 1/2"
- Sockets 1/2 "x 17 BFD, BFD x 10 deep, 2 x spark plug sockets, 8 x outer-TX screws
- Each 1 x Extension 1/2 "125 mm extension 1/2" 250 mm, universal joint 1/2 "bit adapter 1/2" for 10 mm bits
- Bits 10 mm: 6 x for indoor 6-socket, 3 x longitudinal slot, 2 x Phillips PH, 6 x with TX screws, 6 x with TX head hole screws, 5 x for multi-tooth screws, 12 x Ribe
- 9 x angle screwdriver for recessed head screws 6

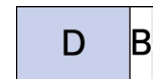
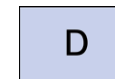

Title	Outside dimension W x H x D	PU Piece	Article No.
TOOL SET 151 BFD FOAM 60T	556 x 33 x 337 mm	1	213285
AGR: 03.701			
Scope Of Supply		Amount	Article No.
FOAM TOOL SET 151 BFD 60 T		1	210771

Hard foam inlay with I-socket 1/2" inclusive lever ratchet 60 T

Scope Of Delivery

- 1 x lever change ratchet 1/2 " 60 T
- 1 x 125 mm extension
- 1 x 250 mm extension with slider
- 1 x universal joint
- Each 1 x Socket Wrench 1/2 "10 - 12 - 11 - 13 - 14 - 15-16 - 17 - 18 - 19 - 20 - 21 - 22 - 24 - 27 - 30 - 32 mm
- 1 x 1/2 "bit adapter
- Per 1 x 10 mm bit TX 20, TX 25, TX 27, TX 30, TX 40, TX 45, TX 50, TX 55
- 1 Depending x 10 mm hex bit 5 - 6 - 7 - 8 - 10 - 12 mm
- Per 1 x 10 mm multi-tooth bit M 5, M 6, M 8, M 10, M 12



Title	Outside dimension W x H x D	PU Piece	Article No.
S-SET LEVER I SOC. 1/2" HS 60T	228 x 33 x 337 mm	1	213267

AGR: 03.701

Scope Of Supply

	Amount	Article No.
FOAM LEVER I SOCKET 1/2" 60T	1	210767

Hard Foam Inlet with 1/2" I-socket incl. Flex Ratchet Handle

Scope Of Delivery

- 1 x 1/2" flex ratchet handle, fine toothed
- 1 x Extension 125 mm
- 1 x Extension 250 mm with gliding head
- 1 x Cardan Joint
- 1 x 1/2" socket wrench insert 10 - 11 - 12 - 13 - 14 - 15 - 16 - 17 - 18 - 19 - 20 - 21 - 22 - 24 - 27 - 30 - 32 mm
- 1 x 1/2" Bit-Adapter
- 1 x 10 mm bit TX 20, TX 25, TX 27, TX 30, TX 40, TX 45, TX 50, TX 55
- 1 x 10 mm bit allen 5 - 6 - 7 - 8 - 10 - 12 mm



- 1 x 10 mm bit multi teeth M 5, M 6, M 8, M 10, M 12

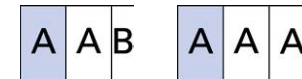

Title	Outside dimension W x H x D	PU Assortment	Article No.
FOAMLINING+I-SOCKET 1/2" AGR: 03.701	228 x 33 x 337 mm	1	039723

Hard Foam Inlett with I-Socket Tool Setl 1/4" and 1/2", 151-pcs., Lever ratchet 60 T

Scope Of Delivery

- Sockets: 1/4 " : 12 x I-Socket, 7 x I-socket deep, 5 x for internal TX screws, 4 x Indoor 6-head screws, 4 x longitudinal slot, 3 x Phillips PH 3 x cross drive PZ, 8 x screws with TX, 8 x with TX-head screw hole
- Each 1 x Extension 1/4 "50 mm extension 1/4" 100 mm, T-Sliding T 1/4 "universal joint 1/4" hand wrench 1/4 "ratchet handle 1/2"
- Sockets 1/2 "x 7 I-socket, 10 x I-socket deep, 2 x spark plug sockets, 8 x outer-TX screws
- Each 1 x Extension 1/2 "125 mm extension 1/2" 250 mm, universal joint 1/2 "bit adapter 1/2" for 10 mm bits
- To 10 mm: 6 x for indoor 6-socket, 3 x longitudinal slot, 2 x Phillips PH, 6 x with TX screws, 6 x with TX head hole screws, 5 x for multi-tooth screws, 12 x Ribe
- 9 x angle screwdriver for recessed head screws 6

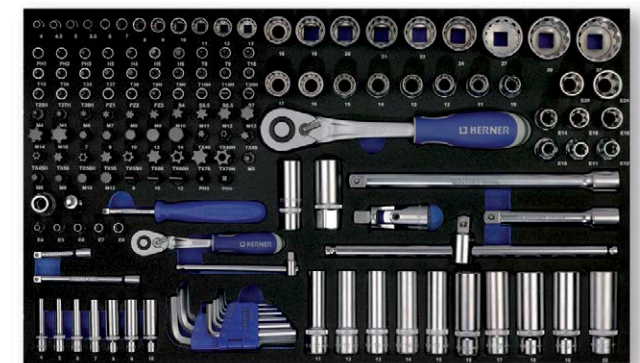

Title	Outside dimension W x H x D	PU Piece	Article No.
TOOL SET 151 I SOCKET FOAM 60T AGR: 03.701	566 x 33 x 337 mm	1	213283

Scope Of Supply

	Amount	Article No.
FOAM TOOL SET 151 I SOCKET 60T	1	210770

INTERNAL/Approved (2019-03-23 00:45:14)

Hard Foam Inlet with 3/4" Socket Wrench Set

Scope Of Delivery

- 1 x 3/4" socket wrench insert in each of the wrench sizes WS 21 - 22 - 24 - 27 - 30 - 32 - 34 - 36 - 38 - 41 - 46 - 50 mm
- 1 x flex ratchet handle
- 1 x t-shaped sliding handle
- 2 x extensions 125 and 250 mm

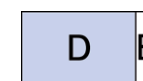
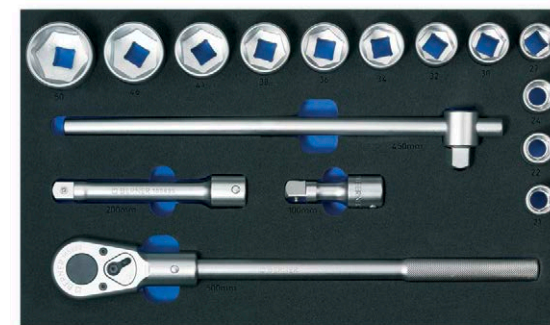

Title	Outside dimension W x H x D	PU Assortment	Article No.
FOAMLING+SOCKET-SET 3/4" AGR: 03.701	566 x 33 x 337 mm	1	052809

Hard Foam Inlet with Socket Wrench Inserts Inner Hex 1/2"

Scope Of Delivery

- 1 x socket wrench insert 1/2" hex in each of the wrench sizes 4 - 5 - 6 - 7 - 8 - 10 - 12 - 14 - 17 mm



Title	Outside dimension W x H x D	PU Assortment	Article No.
FOAMLING + SOCKETS 1/2" HEX AGR: 03.701	110 x 33 x 337 mm	1	039721

Scope Of Supply

	Amount	Article No.
Hard Foam Inlet for Socket Wrench Inserts Inner Hex empty	1	039450

Foam Inlay with Sockets 1/4", 3/8", 1/2", deep, 12-point

Characteristics

- Deep sockets
- 12-point

Scope Of Delivery

- 1/4" - 4, 5, 6, 7, 8, 9, 10 mm
- 3/8" - 10, 11, 12, 13, 14, 15, 16, 17, 19 mm
- 1/2" - 13, 14, 15, 16, 17, 18, 19, 21, 22, 24, 27, 30, 32 mm

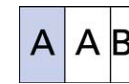
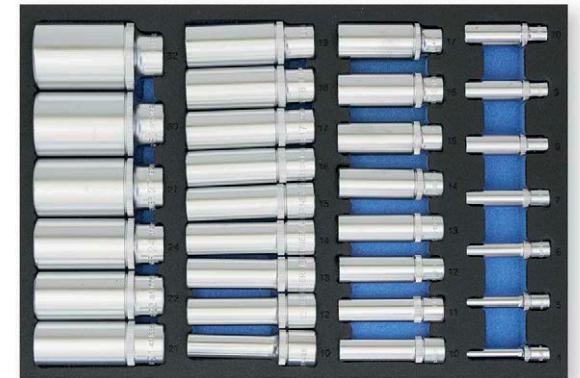

Title	PU Piece	Article No.
Sockets 1/4", 3/8", 1/2", deep, 12-point AGR: 03.018	1	336364

Hard Foam Inlets with Long 3/8" and 1/2" Socket Wrench Inserts

Scope Of Delivery

- 1 x 3/8" socket wrench insert in each of the wrench sizes 9 - 10 - 11 mm
- 1 x 1/2" socket wrench insert in each of the wrench sizes 12 - 13 - 14 - 15 - 16 - 17 - 18 - 19 mm

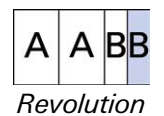
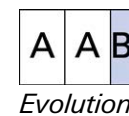

Title	Outside dimension W x H x D	PU Assortment	Article No.
FOAMLINING + SOCKET LONG AGR: 03.701	110 x 33 x 337 mm	1	039719

Hard Foam Inlet with Socket, Inner-TX 1/2" Short

Characteristics



INTERNAL/Approved (2019-03-23 00:45:36)

Workshop trolleys

- Execution dull chrome plated. With knurl at the base. For manual operation. High-quality 5 / 16" bit for higher breaking torque, tough and hard material for the highest standards. With ball retaining groove. Made in USA.

Scope Of Delivery

- 1 x TX socket wrench inserts: TX20 - TX25 - TX27 - TX30 - TX40 - TX45 - TX50 - TX55 - TX60

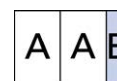

Title	Outside dimension W x H x D	PU Piece	Article No.
I-TX SET 1/2 9PC	110 x 33 x 337 mm	1	101030

AGR: 03.018

Scope Of Supply

	Piece	Article No.
Empty Hard foam insert wit socket, Inner-TX 1/2" Short	1	116512
Inner TX 20 Socket Wrench Insert 1/2" short	1	101021
Inner TX 25 Socket Wrench Insert 1/2" short	1	101022
Inner TX 27 Socket Wrench Insert	1	101023
Inner TX 30 Socket Wrench Insert 1/2" short	1	101024
Inner TX 40 Socket Wrench Insert 1/2" short	1	101025
Inner TX 45 Socket Wrench Insert 1/2" short	1	101026
Inner TX 50 Socket Wrench Insert 1/2" short	1	101027
SKET. Spanner I-TX T55 1/2 59	1	187182
SKET. Spanner I-TX T60 1/2 59	1	187181

Related Products

	PU Amount	Article No.
Inner TX Socket Wrench Insert 1/2" T70 short	1	136382

Hard Foam Inlets with Socket, Inner TX 1/2" Short and Long

Scope Of Delivery

- Short Design:
TX20 - TX25 - TX27 - TX30 - TX40 - TX45 - TX50 - TX55 - TX60



- Long Design:
TX20 - TX25 - TX27 - TX30 - TX40 - TX45 - TX50 - TX55

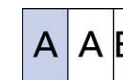
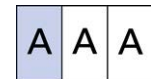
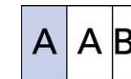

Title	Outside dimension W x H x D	PU Piece	Article No.
I-TX SET 1/2 17PC	226 x 33 x 331 mm	1	116507
AGR: 03.018			
Scope Of Supply		Piece	Article No.
Inner TX 20 Socket Wrench Insert 1/2" short		1	101021
Inner TX 25 Socket Wrench Insert 1/2" short		1	101022
Inner TX 27 Socket Wrench Insert		1	101023
Inner TX 30 Socket Wrench Insert 1/2" short		1	101024
Inner TX 40 Socket Wrench Insert 1/2" short		1	101025
Inner TX 45 Socket Wrench Insert 1/2" short		1	101026
Inner TX 50 Socket Wrench Insert 1/2" short		1	101027
SKET. Spanner I-TX T55 1/2 59		1	187182
SKET. Spanner I-TX T60 1/2 59		1	187181
Inner-TX Socket Wrench Insert, long TX 1/2" T20		1	115452
Inner-TX Socket Wrench Insert, long 1/2" TX27		1	115453
Inner-TX Socket Wrench Insert, long 1/2" T27		1	115451
Inner-TX Socket Wrench Insert, long 1/2" T30		1	115450
Inner-TX Socket Wrench Insert, long T40 1/2"		1	115446
Inner-TX Socket Wrench Insert, long T45 1/2"		1	115444
Inner-TX Socket Wrench Insert, long T50 1/2"		1	115454
Inner-TX Socket Wrench Insert, long T55 1/2"		1	115437

INTERNAL/Approved (2019-03-23 00:45:59)

Related Products

Inner TX Socket Wrench Insert 1/2" T70 short

PU
Amount

Article No.

1 136382

Foam Inlay with Socket 1/4", 3/8", 1/2" as Torx and E-Torx

Scope Of Delivery

- **Socket E-Torx:**
 - 1/4" - E5, E6, E7, E8
 - 3/8" - E8, E10, E11, E12, E14
 - 1/2" - E14, E16, E18, E20, E24
- **Socket Insert Torx:**
 - 1/4" - T8, T9, T10, T15, T20, T25
 - 3/8" - T20, T25, T27, T30, T40, T45, T50
 - 1/2" - T25, T27, T30, T40, T45, T50, T55, T60



A A B

A A A

Title

PU
Piece

Article No.

Sockets 1/4", 3/8", 1/2" as Torx and E-Torx

1

336348

AGR: 03.018

Hard Foam Inlet with TX 1/4", 3/8", 1/2"

Scope Of Delivery

- 1x internal TX: TX 20, TX 25, TX 27, TX 30, TX 40, TX 45, TX 50, TX 55
- TX 60
- 1x internal TX: E 4, E 5, E 6, E 8, E 10, E 12, E 14, E 18, E 20, E 24
- Joint for inserts: 1/4" x 3/8", 5/16" x 1/2"
- 1x power-use bit 110 mm: TX 25, TX 40, TX 45, TX 55



A A B

A A BB



Title

Outside dimension W x H x D

PU
Assortment

Article No.

FOAMLINING + SPANN.SET TORX

110 x 33 x 337 mm

1

039720

AGR: 03.701

Hard Foam Inlet with Multi Teeth 1/2" Socket Wrench Inserts

Scope Of Delivery

- 1 x multi teeth socket wrench insert
- Length: 55 mm = wrench size 5 - 6 - 8 - 10 - 12 - 14 - 16
- Length: 100 mm = wrench size 8 - 10 - 12
- Length: 110 mm = wrench size 6 - 14
- Length: 120 mm = WS 10
- Length: 140 mm = WS 9 - 12

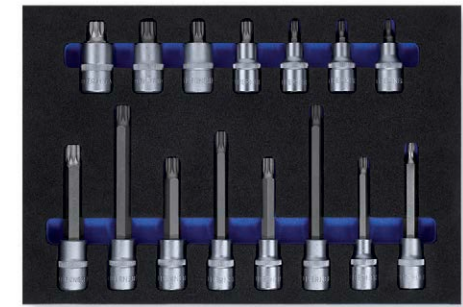

Title	Outside dimension W x H x D	PU Piece	Article No.
FOAMLINING+SOCKET XZN 1/2" AGR: 03.701	228 x 33 x 337 mm	1	082561

Hard Foam Inlet with 1/2" Impact Heavy Socket

Scope Of Delivery

- 1 x 1/2" impact socket wrench insert in each of the wrench sizes plastic coated 17 - 19 - 21 mm
- 1 x 1/2" impact cardan joint 17 - 19 mm

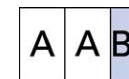

Title	Outside dimension W x H x D	PU Assortment	Article No.
Hard Foam Inlet for 1/2" Impact Socket AGR: 03.701	110 x 33 x 337 mm	1	043937

INTERNAL/Approved (2019-03-23 00:46:43)

Hard Foam Inlet with Extra Deep 1/2" Impact Socket Set

Scope Of Delivery

- 1 x extra deep 1/2" impact socket insert, in each of the wrench sizes, WS 13 - 15 - 16 - 18 - 21 - 22 - 24 - 27 - 30 - 32 mm
- 1 x 1/2" impact extension 125 mm
- 1 x 1/2" impact cardan joint

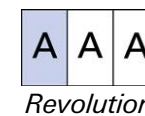
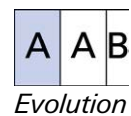

Title	Outside dimension W x H x D	PU Assortment	Article No.
FOAMLINING+IMPACT SOCKET 1/2" AGR: 03.701	228 x 33 x 337 mm	1	043938

Impact Socket Premium Set 6 pc's



Title	PU Piece	Article No.
Premium Impact Socket Set 6 pcs AGR: 03.018	1	245170
Scope Of Supply	Piece	Article No.
Premium Impact Socket, Smart	1	245245
Premium Impact Socket	1	245242
Premium Impact Socket, MB	1	245244
Premium Impact Socket	1	245241
Premium Impact Socket	1	245240
Premium Impact Socket, Opel	1	245239

Claw foot spanner Set Car

Title	PU Piece	Article No.
Claw foot spanner Set Car	1	336409
AGR: 03.018		
Scope Of Supply	Amount	Article No.
Claw foot spanner 3/8", 10 mm	1	336408
Claw foot spanner 3/8", 11 mm	1	336407
Claw foot spanner 3/8", 12 mm	1	336402
Claw foot spanner 3/8", 13 mm	1	336405
Claw foot spanner 3/8", 14 mm	1	336401
Claw foot spanner 3/8", 15 mm	1	336403
Claw foot spanner 3/8", 16 mm	1	336406
Claw foot spanner 3/8", 17 mm	1	336400
Claw foot spanner 3/8", 18 mm	1	336404
CLAW SPANNER SIZE 19 3/8"	1	207103

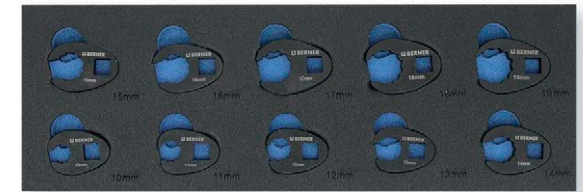

Set claw spanner NFZ

- Ideal for nut and pipe fittings
- 12-point profile allows small return angle of only 30 °
- 10-TLGs. Set for a variety of applications, particularly in the commercial vehicle sector
- Delivery in Berner's foam ticking (337 x 228 mm),
- ideal for Berner's Workshop trolley system

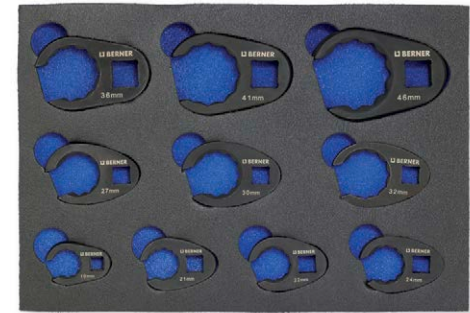

A A B

A A A



Title	Drive	PU Piece	Article No.
SET CLAW SPANNERS CV	/ 12KT	1	200858
AGR: 03.018			
Scope Of Supply		Piece	Article No.
CLAW SPANNER SIZE 19 3/8"		1	207103
CLAW SPANNER SIZE 21 1/2"		1	207102
CLAW SPANNER SIZE 22 1/2"		1	207101
CLAW SPANNER SIZE 24 1/2"		1	207100
CLAW SPANNER SIZE 27 1/2"		1	207099
CLAW SPANNER SIZE 30 1/2"		1	207097
CLAW SPANNER SIZE 32 1/2"		1	207096
CLAW SPANNER SIZE 36 3/4"		1	207095
CLAW SPANNER SIZE 41 3/4"		1	207176
CLAW SPANNER SIZE 46 3/4"		1	200860

Foam Inlay for Oilservice

Scope Of Delivery

- Each 1 x magnetic socket 3/8 ": 13-14-17-18-19-21 mm
- Each 1 x magnet Allen wrench 3/8 ": 8-10-12-13-14-17 mm
- Each 1 x magnet square 3/8 ": 8-10 mm
- Magnetic wrench 3/8 "TX 45
- Oil filter clamping band 65-105 mm
- Adapter 3/8 "to 1/2"



Title	PU Piece	Article No.
Foam Inlay for Oilservice	1	336347
AGR: 03.018		

Hard Foam Inlet with Double Open-Ended Wrench Set

Scope Of Delivery

- 1 x double open-ended wrench in each of the wrench sizes 6x7
- 8x9
- 10x11
- 12x13
- 14x15
- 16x17
- 18x19
- 20x22
- 21x23
- 24x27 mm



A	A	B
---	---	---

A	A	A
---	---	---



A	A	B	A	A	A
---	---	---	---	---	---

Title	Outside dimension W x H x D	PU Assortment	Article No.
FOAMLINING+DOUBLERINGWRENCH AGR: 03.701	228 x 33 x 337 mm	1	034581

Foam Inlay with Double Fork Spanner Set Super Slim



A	A	B
---	---	---

A	A	A
---	---	---

A	A	B
---	---	---

A	A	A
---	---	---

Title	PU Piece	Article No.
Double Fork Spanner Set Super Slim	1	336249

AGR: 03.701

Scope Of Supply

	Amount	Article No.
Double Open-Ended Spanner Super Slim 10 x 11 mm	1	336231
Double Open-Ended Spanner Super Slim 12 x 13 mm	1	336230
Double Open-Ended Spanner Super Slim 14 x 15 mm	1	336233
Double Open-Ended Spanner Super Slim 16 x 17 mm	1	336227
Double Open-Ended Spanner Super Slim 18 x 19 mm	1	336229
Double Open-Ended Spanner Super Slim 20 x 22 mm	1	336232
Double Open-Ended Spanner Super Slim 21 x 23 mm	1	336235
Double Open-Ended Spanner Super Slim 6 x 7 mm	1	336234
Double Open-Ended Spanner Super Slim 8 x 9 mm	1	336228

INTERNAL/Approved (2019-03-23 00:47:57)

Hard Foam Inlet with Deep Offset Double Open-Ended Wrench

Scope Of Delivery

- 1 x double double open-ended wrench in each of the wrench sizes 6 x 7
- 8 x 9
- 10 x 11
- 12 x 13
- 14 x 15
- 16 x 17
- 18 x 19
- 20 x 22
- 21 x 23 mm

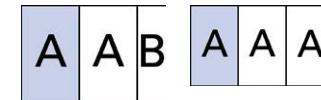
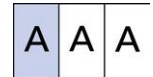
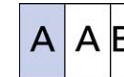
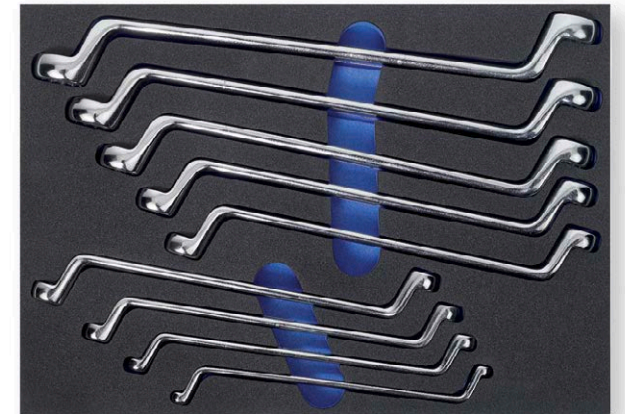

Title	Outside dimension W x H x D	PU Assortment	Article No.
FOAMLINING+DO.RING SPANN. AGR: 03.701	228 x 33 x 337 mm	1	034580

Hard Foam Inlet with combination wrench set

Scope Of Delivery

- 1 x combination wrench in each of the wrench sizes 6 - 7 - 8 - 9 - 10 - 11 - 12 - 13 - 14 - 15 - 16 - 17 - 18 - 19 - 21 - 22 - 24 - 27 mm



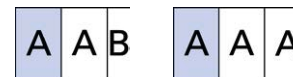

Title	Outside dimension W x H x D	PU Assortment	Article No.
Hard foam tool inlet with combination wrench	228 x 33 x 337 mm	1	034582

AGR: 03.701

Hard Foam Inlet with Double Open-Ended/ Combination Wrench Set

Scope Of Delivery

- 1 x double open-ended in each of the wrench sizes 22 x 24, 24 x 27, 30 x 32, 30 x 34 mm
- 1 x combination wrench in each of the wrench sizes, wrench size 30, 32, 34, 36 mm

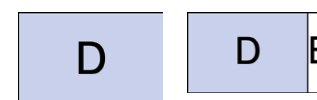
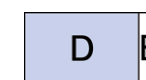

Title	Outside dimension W x H x D	PU Assortment	Article No.
FOAMLININGRINGSPAN/COMB.SPAN.	566 x 33 x 337 mm	1	039722

AGR: 03.701

Hard Foam Inlet with Non-Slip Combination Ratcheting Box-End Wrench

- Versatile applicable due to the I-socket-profile on the ring ratchet, covers all common square, hexagonal, ten-sectioned, double hex, multi-toothed, inch and outside-TXT-screws
- Ratchet with left/right switch, 15° angled
- Applicable even on tight areas, because during the ratcheting only little space is needed (only for 4°) on the basis of the finely toothed ratchet with 90 teeth
- Now profile (non-slip) at the open-end enables also application on screw heads and nuts, which are 60% rounded

Hints

- Suitable for Smart-Box empty 43572

Scope Of Delivery

- Each 1 Fork-Ring Ratchet Wrench Non-Slip WS 8 - 10 - 11 - 12 - 13 - 14 - 15 - 16 - 17 - 18 - 19

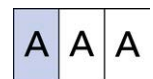

Title	Outside dimension W x H x D	PU Assortment	Article No.
FOAMLINING+NON-SLIP AGR: 03.701	228 x 33 x 337 mm	1	043942

Foam Inlay with Fork/Ring-Ratchet Spanner, Straight

Scope Of Delivery

- Includes one Pc. from 8-9-10-11-12-13-14-15-16-17-18-19 mm

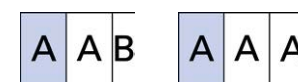
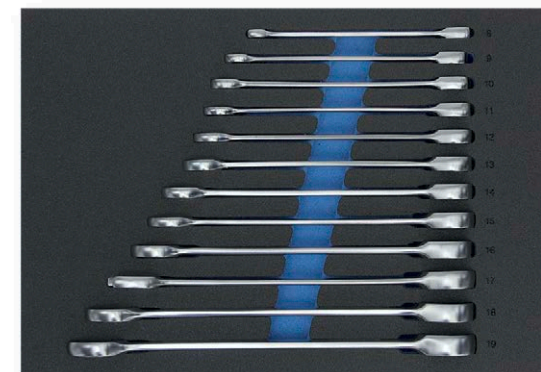

Title	PU Piece	Article No.
Foam In. w. Fork/Ring-Ratchet Sp., Straight AGR: 03.701	1	336349

Hard Foam Inlet with Combination Ratcheting Box-End Wrench Set with Joint

Scope Of Delivery

- Each 1 x non-slip combination ratcheting box-end wrench with joint in each of the wrench sizes 8 - 9 - 10 - 11 - 12 - 13 - 14 - 15 - 16 - 17 - 18 - 19 mm



Title	Outside dimension W x H x D	PU Assortment	Article No.
FOAMLINING + RING RATCH. AGR: 03.701	228 x 33 x 337 mm	1	039718

Hard foam inlay with Dolphin shaft ring ratchet wrench set with joint

- Open-end spanner with 15° chamfer
- Ratchet combination spanner with an I-socket profile
- Outside ratchet head for sunken screws
- Twisted handle, therefore the spanner lies better in the hand
- In a Smartbox with a foam inlay

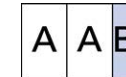
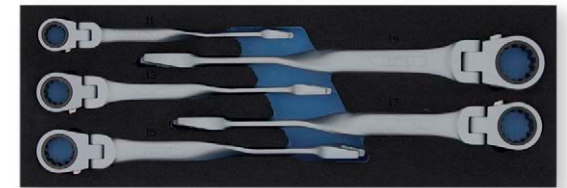

Scope Of Delivery

- 1 combination wrench per joint
SW 10 - 13 - 15 - 17 - 19 mm

Title	Outside dimension W x H x D	PU Piece	Article No.
DOLPHIN TWISTER WRENCH SET	110 x 33 x 337 mm	1	183766

AGR: 03.701

Scope Of Supply

	Piece	Article No.
Dolphin Twister Wrench 10mm	1	183765
Dolphin Twister Wrench 13mm	1	183764
Dolphin Twister Wrench 15mm	1	183763
Dolphin Twister Wrench 17mm	1	183762
Dolphin Twister Wrench 19mm	1	183761

Double Ring Ratchet Wrench Set, Greater Offset

- Versatile, I-Socket-profile covers all standard 6-Kant, 12 Kant, customs and foreign-TX-screws from
- Ratchet with a simple forward / reverse switch
- Applicable even in tight spaces because the ratchets little space is needed (only 4 °) due to the fine-toothed ratchet with 90 teeth

Characteristics

- Delivery with Berner storage and transport case which includes foam inlay, suitable for Evolution and Revolution workshop trolley systems



Title	PU Set	Article No.
Double Ring Ratchet Wrench	1	082419
AGR: 03.701		
Scope Of Supply	Amount	Article No.
Ring Ratchet Wrench 8x10 mm	1	-
Ring Ratchet Wrench 12x14 mm	1	-
Ring Ratchet Wrench 13x15 mm	1	-
Ring Ratchet Wrench 16x18 mm	1	-
Ring Ratchet Wrench 17x19 mm	1	-

Foam Inlay with Ring Ratchet Tube Spanner

- Easy to attach to Hoses or Pipes
- Secure fit on the screw connection
- Very slender construction
- Due to the ratchet system, do not remove the spanner from the screw connection for adjusting.
- Very good to use with tight hydraulic lines or similar
- The additional joint can be used almost anywhere

Application Area

- For loosening and tightening pipe or pipe fittings

Scope Of Delivery

- Each one from SW 10-11-12-13-14-17-19-22-24-27-30-32 mm

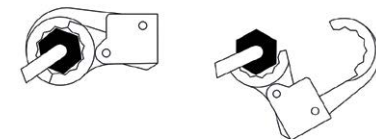
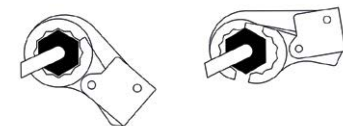
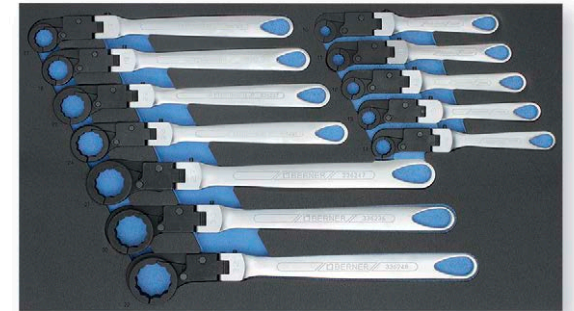

Title	PU Piece	Article No.
Foam Inlay with Ring Ratchet Tube Spanner AGR: 03.701	1	336240

INTERNAL/Approved (2019-03-23 00:49:26)

Workshop trolleys

Scope Of Supply	Amount	Article No.
Ring Ratchet Tube Spanner 10 mm	1	336246
Ring Ratchet Tube Spanner 11 mm	1	336239
Ring Ratchet Tube Spanner 12 mm	1	336244
Ring Ratchet Tube Spanner 13 mm	1	336241
Ring Ratchet Tube Spanner 14 mm	1	336238
Ring Ratchet Tube Spanner 17 mm	1	336243
Ring Ratchet Tube Spanner 19 mm	1	336242
Ring Ratchet Tube Spanner 22 mm	1	336237
Ring Ratchet Tube Spanner 24 mm	1	336245
Ring Ratchet Tube Spanner 27 mm	1	336247
Ring Ratchet Tube Spanner 30 mm	1	336236
Ring Ratchet Tube Spanner 32 mm	1	336248

Ratchet Fork Spanner 3 Size

- Very slim design and therefore also on difficult to access Places
- Self-adjusting to the size
- Ratchet mechanism in the head, thus faster working. No removal of the key from the screw / nut anymore Spanner don't has to be replaced
- Prevents damage to the screw / nut about Wrong size
- Also to be used on damaged screws / nuts
- More secure than conventional keys by self clamping
- Suitable for metric and inch dimensions



Title	PU Piece	Article No.
Ratchet Fork Spanner 3 Size, Set	1	336250

AGR: 03.701

Scope Of Supply	Amount	Article No.
Ratchet Fork Spanner 3 Size, 12-14	1	336252
Ratchet Fork Spanner 3 Size, 15-17	1	336253
Ratchet Fork Spanner 3 Size, 18-20	1	336254
Ratchet Fork Spanner 3 Size, 9-11	1	336251

Hard Foam Inlet with Allen Wrench

Scope Of Delivery

- 1 x allen wrench in the wrench size 1.5 - 2 - 2.5 - 3 - 4 - 5 - 6 - 7 - 8 - 10

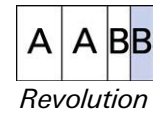
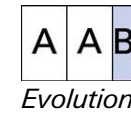

Title	Outside dimension W x H x D	PU Assortment	Article No.
Hard Foam Inlet with Allen Wrench AGR: 03.701	110 x 33 x 337 mm	1	048084

Hard Foam Inlet with Multi-Screwdriver

Scope Of Delivery

- Megapro Bitsch robbery Dreher, Megapro extra bit internal 6-SW edge 2.5 to 4, Megapro extra bit internal 6-kant SW 2-3
- Multi-Ratchet
- Impact screwdriver set

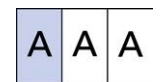

Title	Outside dimension W x H x D	PU Assortment	Article No.
Hard Foam Inlet with Multi-Screwdriver AGR: 03.701	228 x 33 x 337 mm	1	043941

INTERNAL/Approved (2019-03-23 00:49:50)

Hard foam inlet with universal pliers set

Scope Of Delivery

- 1 x pair of 3-component side cutters 145 mm
- 1 x pair of 3-component side cutters 160 mm
- 1 x pair of needle nose 3-component pliers, straight pattern, 205 mm
- 1 x pair of power combination max pliers 180 mm



A A B
Evolution

A A A
Revolution

Title	Outside dimension W x H x D	PU Piece	Article No.
Hard foam inlet with pliers set CPI AGR: 03.701	228 x 33 x 337 mm	1	100541

Foam Inlay with 3K Pliers and Water Pump Pliers MX

- Each tool, without slipping safely stored and in its place
- Missing tools are immediately noticed by a 2-layer, black-brown order system
- The insert is largely resistant to chemicals (against a large number of oils, alkalis and acids), moisture-resistant, stable and long-lasting



Title	PU Piece	Article No.
Pliers Set MX 4 pc's AGR: 03.209	1	341013
Scope Of Supply	Amount	Article No.
Heavy-Duty Combination Pliers „Combi-Max“ 180 mm	1	100534
Side Cutters with 3-Component Soft Grip 160 mm	1	100521
Needle Nose Pliers with 3-Component Soft Grip, Straight 205 mm	1	100529
Hard foam insert for 4pc. Pliers Set MX, empty	1	352182
Water Pump Pliers MX	1	338275

INTERNAL/Approved (2019-03-23 00:49:57)

Pliers Set 3 components 4 pieces

Scope Of Delivery

- 1 x side cutter 3K 160 mm
- 1 x flat round nose pliers straight 3K 205 mm
- 1 x max. power combination pliers 3K 180 mm
- 1 x pocket deLUX "SUN"

Title	Height, External	Depth, Exterior	External Width	PU Piece	Article No.
3-K PLIERSSET 4-PCS SUN	33 mm	337 mm	228 mm	1	134336

AGR: 03.209

Scope Of Supply

	Piece	Article No.
Side Cutters with 3-Component Soft Grip 160 mm	1	100521
Heavy-Duty Combination Pliers „Combi-Max“ 180 mm	1	100534
Needle Nose Pliers with 3-Component Soft Grip, Straight 205 mm	1	100529
"Pocket deLUX "SUN" Micro USB without charger"	1	206957

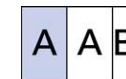

Hard foam inlet with circlip pliers set with multi-grip pliers

Scope Of Delivery

- 1 x for external circlips, 10 – 25 mm
- 1 x for external circlips, 19 – 60 mm
- 1 x for external circlips, 40 – 100 mm
- 1 x for internal circlips, 12 – 25 mm
- 1 x for internal circlips 19 – 60 mm
- 1 x pair of multi-grip pliers 250 mm

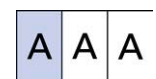
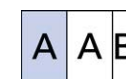

Evolution



Revolution

Title	Height x width x depth	PU Piece	Article No.
FOAMLINING WITH RING PLIERS	33 x 228 x 337 mm	1	121460

AGR: 03.701

Hard Foam Inlet with File Set

Scope Of Delivery

- 1 x brake caliper file
- 1 x key file with wooden handle: flat blunt, flat pointed, half round, round, triangular, square
- 1 x flat blunt file 250 mm
- 1 x triangular file 250 mm
- 1 x half round file 250 mm
- 1 x round file 250 mm

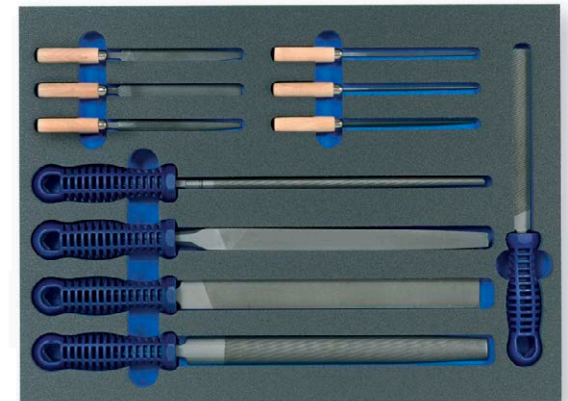

C B

C A

C B C A

INTERNAL/Approved (2019-03-23 00:50:28)

Title

Outside dimension W x H x D

PU
Assortment

Article No.

Hard foam inlet with hammer tool set

Scope Of Delivery

- 1 x Topline hammer 500g
- 1 x Plastic hammer 350g
- 1 x Flat chisel
- 1 x Prick punch, 8-edged, 12 mm x 120 mm
- 1 x Split pin tool in each of the diameters 3, 4, 5, 6 mm



A	A	B
---	---	---

A	A	A
---	---	---

A	A	B	A	A	A
---	---	---	---	---	---

Title	Outside dimension W x H x D	PU Assortment	Article No.
Empty hard foam inlet with hammer tool set	228 x 33 x 337 mm	1	039716

AGR: 03.701

Scope Of Supply

	Piece	Article No.
Locksmith's Hammer	1	244581
Plastic Hammer	1	244614
Sheet Metal Flat Chisel DIN 6453 Lenght 200 mm 5000/8	1	068209
Split Pin Tool 3 mm	1	068411
Split Pin Tool 4 mm	1	068420
Split Pin Tool 5 mm	1	068438
Split Pin Tool 6 mm	1	068446
Center Punch in accordance with DIN 7250	1	068390
039448 Hard foam insert for hammer tool set, empty	1	039448

INTERNAL/Approved (2019-03-23 00:50:39)

Hard foam inlet with pin punch with hand protection

Scope Of Delivery

- 1 x Pin Punch with Ø of 3, 4, 5, 6, 8 mm

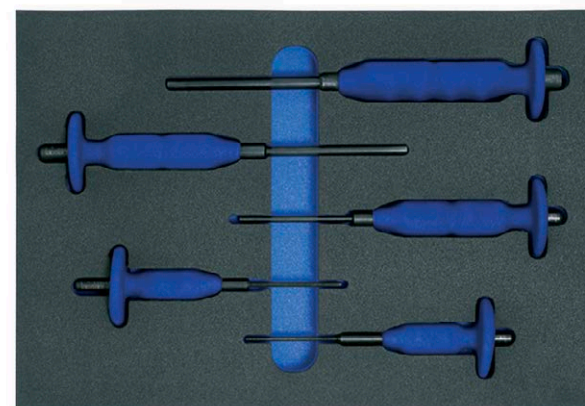
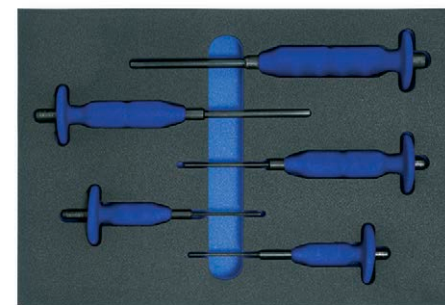

16

Title	Outside dimension W x H x D	PU Assortment	Article No.
Hard foam insert for pin punch AGR: 03.701	228 x 33 x 337 mm	1	043943

Hook Set

Application Area

- Ideal for insertion and removal of O-rings
For assembly and disassembly of seals

Characteristics

- With ergonomic plastic handle, supplied complete with practical foam inserts two diameters

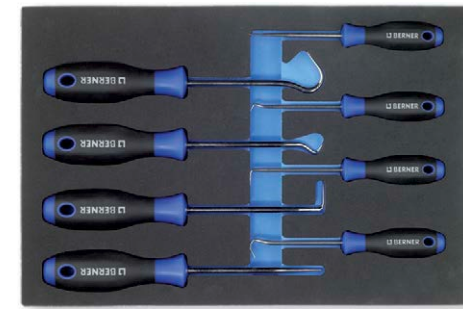

Title	PU Piece	Article No.
HOOKSET 8-PC	1	131361
AGR: 03.701		
Scope Of Supply	Piece	Article No.
Hook streight 150mm	1	131357
Hook angled 65° 150mm	1	131359
Hook angled 90° 150mm	1	131362
Hook angled 125° 150mm	1	131364
Hook streight 280mm	1	131358
Hook angled 55° 280mm	1	131360
Hook angled 90° 280mm	1	131363
Hook angled 132° 280mm	1	131365

Hard Foam Inlet with Measuring- /and Cutting Set

Scope Of Delivery

- 1 x scriber 250 mm
- 1 x pocket measuring tape 3m
- 1 x pocket caliper 150mm
- 1 x magazine cutter blue line 100/18
- 1 x saw frame saw blade
- 10 x saw blades 32 teeth



A	A	B
---	---	---

Evolution

A	A	A
---	---	---

Revolution

Title	Outside dimension W x H x D	PU Assortment	Article No.
FOAMLINING+MEASURE/CUTTING AGR: 03.701	228 x 33 x 337 mm	1	051569

Foamlining with Cutter



Title	Outside dimension W x H x D	PU Amount	Article No.
Foamlining for Cutter	228 x 33 x 337 mm	1	218368
Foamlining with Cutter	228 x 33 x 337 mm	1	219381

AGR: 03.701 / 08.104

Hard Foam Inlet with PU Scraper with 30 blades

Scope Of Delivery

- 1 x PU scraper handle
- Each 10 x blades 12-16 - 20 mm

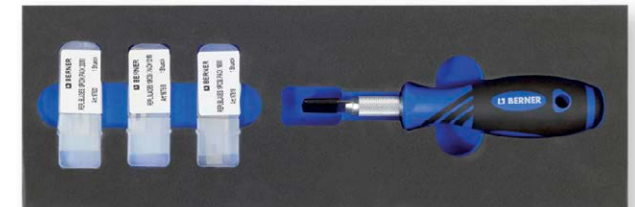

Title	Outside dimension W x H x D	PU Assortment	Article No.
Hard Foam Inlet with PU-Scraper AGR: 03.701	110 x 33 x 337 mm	1	043944
Spare Parts		PU Piece	Article No.
Extra Blades 12 mm 10 piece		1	167518
Extra Blades 16 mm 10 piece		1	167519
Extra Blades 20 mm 10 piece		1	167520

Hard Long Foam Inlet for "Revolution" - Balancing Part/Empty Compartment

Application Area

- For fixing the tool organizers at the front and back in the drawers of the "Revolution" workshop cart

Characteristics

- Ideal for small parts



Title	Outside dimension W x H x D	PU Piece	Article No.
Hard long foam inlet – balancing part AGR: 08.104	682 x 51 x 59 mm	1	042262

INTERNAL/Approved (2019-03-23 00:51:14)

Hard Foam Inlet - Balancing Part/ Empty Compartment

Characteristics

- Ideal for small parts

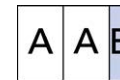

Title	Outside dimension W x H x D	PU Piece	Article No.
FOAMLINING COMPENSAT/EMPTY COM AGR: 08.104	110 x 51 x 337 mm	1	039440

Hard Foam Inlet - Cube Foam

Application Area

- For individual partitioning of organizers for various parts
- Small and pre-punched parts with a cubic shape enable precise separation

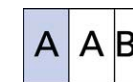
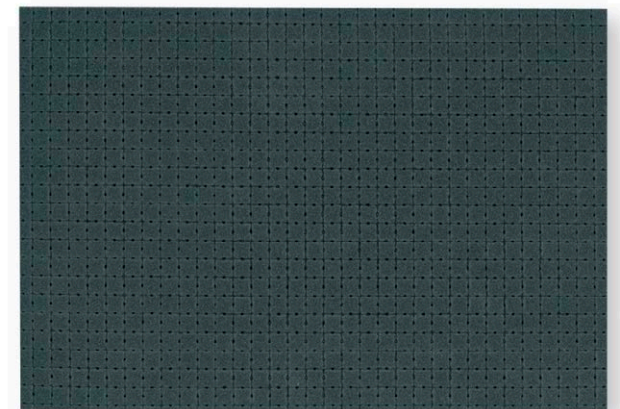
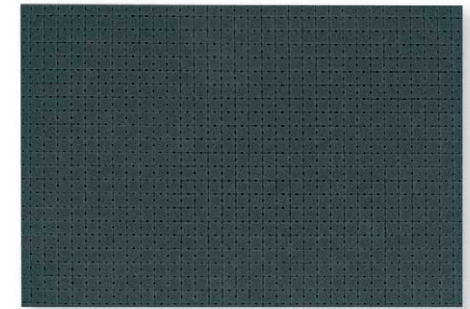

Title	Outside dimension W x H x D	PU Piece	Article No.
Hard foam inlet – cube foam	228 x 33 x 337 mm	1	039457

AGR: 08.104

Terminal Release Tool Set

- The compact, ergonomic and blue anodized aluminum handles with collar and knurled edges guarantee safe working without slipping off.
- Due to the very short design of the unlocking, even hard-to-reach cable plug connections can be unlocked without any problem.
- In the unlocking process, the barbed hooks of the tool are pressed against the connecting clamp, whereby the cable with plug can then be pulled out
- The unlocking set allows easy, damage-free and time-saving unlocking through the various inserts
- Everything is neatly packaged in a foam insert



INTERNAL/Approved (2019-03-23 00:51:33)

Hints

- 2801 (Art.-Nr.335603): Audi, BMW, Ford, Mercedes, Opel, Renault, Seat, VW
- 2802 (Art.-Nr.335602): Audi, BMW, Ford, VW
- 2803 (Art.-Nr.335601): Audi, BMW, Ford, Mercedes, Opel, Renault, Seat, VW
- 2804 (Art.-Nr.335600): BMW, Ford
- 2805 (Art.-Nr.335599): Audi, BMW, Mercedes, Opel, Seat, Skoda, VW
- 2806 (Art.-Nr.335598): Audi, BMW, Mercedes, Opel, Renault, Seat, Skoda, VW
- 2807 (Art.-Nr.335597): BMW, Mercedes
- 2808 (Art.-Nr.335596): Audi, Seat, Skoda, VW
- 2809 (Art.-Nr.335595): Audi, Opel, Renault
- 2810 (Art.-Nr.335549): BMW, Mercedes
- 2811 (Art.-Nr.336693): BMW, Mercedes
- 2812 (Art.-Nr.335592): Audi, BMW, Mercedes, Opel, Seat, VW
- 2813 (Art.-Nr.335591): BMW, Mercedes, Opel
- 2814 (Art.-Nr.335590): BMW, Mercedes
- 2815 (Art.-Nr.335589): Audi, BMW, Opel, VW
- 2816 (Art.-Nr.335588): BMW, Mercedes
- 2817 (Art.-Nr.335587): Audi, BMW, Mercedes, Skoda, Opel, Seat, VW
- 2818 (Art.-Nr.335586): Audi, BMW, Mercedes, Opel, Seat, Skoda, VW
- 2819 (Art.-Nr.335585): Audi, BMW, Ford, Mercedes, Opel, Renault, Seat, VW
- 2820 (Art.-Nr.335584): Halteklemmen zurückformen

Title	PU Piece	Article No.
Terminal Release Tool Set	1	335435

AGR: 03.209

Scope Of Supply	Amount	Article No.
Terminal Release Tool 2820	1	335584
Terminal Release Tool 2801	1	335603
Terminal Release Tool 2802	1	335602
Terminal Release Tool 2803	1	335601
Terminal Release Tool 2804	1	335600

Scope Of Supply	Amount	Article No.
Terminal Release Tool 2805	1	335599
Terminal Release Tool 2806	1	335598
Terminal Release Tool 2807	1	335597
Terminal Release Tool 2808	1	335596
Terminal Release Tool 2809	1	335595
Terminal Release Tool 2810	1	335594
Terminal Release Tool 2811	1	335593
Terminal Release Tool 2812	1	335592
Terminal Release Tool 2813	1	335591
Terminal Release Tool 2814	1	335590
Terminal Release Tool 2815	1	335589
Terminal Release Tool 2816	1	335588
Terminal Release Tool 2817	1	335587
Terminal Release Tool 2818	1	335586
Terminal Release Tool 2819	1	335585

Hard foam inlay empty

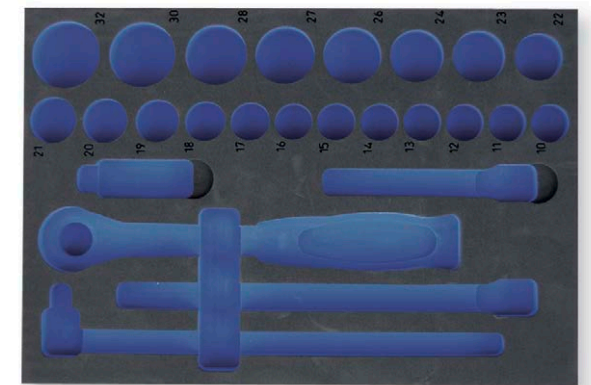

Workshop trolleys

Title	Outside dimension W x H x D	PU Piece	Article No.
INLETT EMPTY 240301	-	1	248639
Lid Foam Inlay SB XL	-	1	210493
Foam Inlay Test Equipment empty, const	-	1	329150
Foam Inlay Test Equipment empty KFZ	-	1	329151
EXPANDED.POLY.SKT SPANN1/4"LS	110 x 33 x 337 mm	1	048110
FOAM LEVER BFD 1/2" 60T	110 x 33 x 337 mm	1	210769
FOAM LEVER BFD 1/4" 1/2" 60T	110 x 33 x 337 mm	1	210772
FOAM LEVER BFD 1/4" 3/8" 60T	110 x 33 x 337 mm	1	210768
FOAM LEVER BFD 1/4" 60T	110 x 33 x 337 mm	1	210764
FOAM LEVER BFD 3/8" 60T	110 x 33 x 337 mm	1	210765
FOAM LEVER I SOCKET 1/2" 60T	110 x 33 x 337 mm	1	210767
FOAM LEVER I SOCKET 1/4" 60T	110 x 33 x 337 mm	1	210766
Empty Hard Foam Inlet with Allen Wrench	110 x 33 x 337 mm	1	047821
FOAMLINING IMPACTSOCKET	110 x 33 x 337 mm	1	043556
FOAMLINING SOCKET 1/2" HEX	110 x 33 x 337 mm	1	039450
FOAMLINING SOCKET LONG	110 x 33 x 337 mm	1	039449
Empty Hard Foam Inlet for TX 33 x 110 x 337	110 x 33 x 337 mm	1	039456
FOAMLINING I-SOCKET 1/4"	110 x 51 x 337 mm	1	039444
Empty hard foam inlet for pliers set CPI	228 x 33 x 337 mm	1	105886
EXPANDED.POLY.SKT SPANN.1/2"LS	228 x 33 x 337 mm	1	048113
EXPANDED.POLY.SKT SPANN.3/8"LS	228 x 33 x 337 mm	1	048112
Foam insert for 4pc. Pliers Set MX, empty	228 x 33 x 337 mm	1	352182
FOAMLINING I-SOCKET 1/2" LS	228 x 33 x 337 mm	1	048114
Empty Hard foam inlet for loop ratchet	228 x 33 x 337 mm	1	039446
FOAMLINING NON-SLIP	228 x 33 x 337 mm	1	043552
Empty Hard Foam Inlet for Pliers Set 3	228 x 33 x 337 mm	1	043557
FOAMLINING RING PLIERS	228 x 33 x 337 mm	1	121184
FOAMLINING RING RATCH. 2	228 x 33 x 337 mm	1	044418
Empty hard foam insert for pin punch	228 x 33 x 337 mm	1	043554
EXPANDED. POLY. COMBIWRENCH	228 x 51 x 337 mm	1	033956
EXPANDED. POLY. DO. COM.WRENCH	228 x 51 x 337 mm	1	033958
EXPANDED. POLY. DOUB.WRENCH	228 x 51 x 337 mm	1	033957

Title	Outside dimension W x H x D	PU Piece	Article No.
Hard foam inlet for hammer tool set, empty	228 x 51 x 337 mm	1	039448
Empty Hard Foam Inlet for File Set	456 x 51 x 337 mm	1	039443
FOAMLINING 3/4" SET EPE	566 x 33 x 337 mm	1	052682
FOAM TOOL SET 151 BFD 60 T	566 x 33 x 337 mm	1	210771
FOAM TOOL SET 151 I SOCKET 60T	566 x 33 x 337 mm	1	210770
FOAMLINING RINGSPAN/COMB.SPAN.	566 x 51 x 337 mm	1	039442

AGR: 03.105 / 08.104

Service Car 150KG GFK

- The plastic version avoids damages of the vehicle paint in case of light brushes
- The deposit trays are closed, and they are oil and fuel resistant
- Objects which may leak can be safely placed on the vehicle
- The big wheels ensure an easy and safe manoeuvring in the workshop, also on uneven floor

Hints

- No brakes



Title	PU Piece	Article No.
PZS-303-2B PLASTIC SERVICE CAR	1	111146
AGR: 08.100		
Spare Parts	PU Amount	Article No.
Spare wheel fix for 111146	1	341397
Spare wheel steer for 111146	1	341337

Trolley

- The handle is removeable and can be stored very easily. Also in cars
- Contact area is made from robust plastic, with 2 practical openings for carrying and with anti-slip covering
- Very light
- Very easy to drive due to big wheels
- Very robust and versatile
- Can be used for the transportation of tyres as well

Application Area

- For the transportation of objects

Technical Data

Weight	14 kg
Max load capacity	300 kg



Title	External Width	Height, External	Depth, Exterior	Height, folded	PU Piece	Article No.
PLATFORM TRUCK 300 KG	590 mm	900 mm	900 mm	270 mm	1	175082

AGR: 08.100

Spare Parts

	PU Amount	Article No.
SPARE WHEEL FLEXIBLE FOR175082	1	341137
SPARE WHEEL FOR 175082	1	341136

Hose Fittings

Technical Data

Material Brass

Title	For Hose Internal Ø, Inch	PU Piece	Article No.
Hose Fitting	1/2 "	1	034020

AGR: 02.334



Hose Fittings

Technical Data

Material Brass

Title	For Hose Internal Ø, Inch	PU Piece	Article No.
Hose Fitting	1/2 "	1	034019
NOZZLE BRASS W.FAST COUPL.1"	1 "	1	052457
Hose Fitting	3/4 "	1	033984

AGR: 02.334



Hose Fittings

Technical Data

Material Brass

Title	For Hose Internal Ø, Inch	PU Piece	Article No.
FAST COUPLING BRASS 1" IT	1 "	1	052459
Hose Fitting	3/4 "	1	034025

AGR: 02.334

Hose Fittings

Technical Data

Material Brass

Title	For Hose Internal Ø, Inch	PU Piece	Article No.
Hose Fitting	1/2 "	1	034026
FAST COUPLING BRASS 1" OT	1 "	1	052458
Hose Fitting	3/4 "	1	034027

AGR: 02.334



Hose Fittings

Technical Data

Material Brass

Title	For Hose Internal Ø, Inch	PU Piece	Article No.
Hose Fitting	1/2 "	1	034023
HOSE-COUPLING BRASS 1"	1 "	1	052456
Hose Fitting	3/4 "	1	034024

AGR: 02.334



Hose Fittings

Technical Data

Material Brass

Title	For Hose Internal Ø, Inch	PU Piece	Article No.
FIX CLAMP 1"	1 "	1	052461
FIX CLAMP 3/4"	3/4 "	1	052460

AGR: 02.334 / 08.695



Quick connect Formdichtung moulded seal

Application Area

- Suitable for all above couplings

Title	External-Ø	Wall Thickness	PU Piece	Article No.
QUICK COUPLING FORMSEAL 33 mm		6 mm	10	080984

AGR: 08.695



Hose connector without waterstop

Technical Data

Material Plastic

Title	For Hose Internal Ø, Inch	PU Piece	Article No.
HOSE-COUPLING PL. 1/2" WO.STOP	1/2 "	1	186239
HOSE-COUPLING PL. 3/4" WO.STOP	3/4 "	1	186241

AGR: 02.334



Hose connector with waterstop

Technical Data

Material Plastic

Title	For Hose Internal Ø, Inch	PU Piece	Article No.
HOSE-COUPLING PL. 1/2" W.STOP	1/2 "	1	186240
HOSE-COUPLING PL. 3/4" W.STOP	3/4 "	1	186242

AGR: 02.334



valve connection IG

- Water-operated coupling made out of plastic used at construction sites

Hints

- Plug couplings are occasionally compatible with systems of other suppliers.

Technical Data

Material		Plastic		
Title	For Hose Internal Ø, Inch	PU Piece	Article No.	
TAP ADAPTER PL. 1" IG	1 "	1	186244	
TAP ADAPTER PL. 3/4" IG	3/4 "	1	186243	

AGR: 02.334



Hose casing patch

Technical Data

Material		Plastic		
Title	For Hose Internal Ø, Inch	PU Piece	Article No.	
HOSE REPAIR KIT 1/2"	1/2 "	1	186249	
HOSE REPAIR KIT 3/4"	3/4 "	1	186248	

AGR: 02.334



Y-Distributor

Technical Data

Material Plastic

Title	PU Piece	Article No.
CONNECTING PIECE Y PLASTIC	1	186246

AGR: 02.334



double connector

- Solid water-operated coupling made out of brass used at construction sites

Hints

- Plug couplings are occasionally compatible with systems of other suppliers.

Technical Data

Material Plastic

Title	PU Piece	Article No.
DOUBLE CONNECTOR PLASTIC	1	186247

AGR: 02.334



component adapter

Technical Data

Material Plastic

Title	For Hose Internal Ø, Inch	PU Piece	Article No.
ACCESSORY ADAPTER 3/4" PLASTIC	3/4 "	1	186250

AGR: 02.334



Extrusion die

Technical Data

Material Plastic

Title	PU Piece	Article No.
SPRAY NOZZLE PLASTIC	1	186245

AGR: 02.334



PVC Hosepipe for Water

- 5-layer construction provides flexibility and stability at high pressure, resistant to twisting and driving over - for simple and easy manual handling
- Soft PVC ensures a long life UV-resistance, kink resistance and abrasion resistance
- The smooth inner surface prevents deposits and guarantees more optimal flow

Characteristics

- High temperature resistance of -20 ° C to +60 ° C, cadmium-free

Hints

- Both hoses have no DVGW approval and are therefore not suitable for drinking water supply.
(DVGW = German Association of Gas and Water Industry Association)

Technical Data

Material Polyvinyl Chloride (PVC)

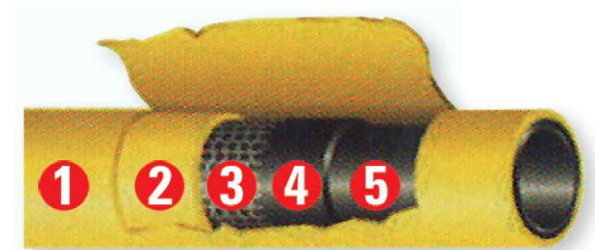

Title	Zoll	Wall Thickness	Operating Pressure, Max.	Burst Pressure	Temperature range	Color	Length	PU Amount	Article No.
PVC Hosepipe for Water	1/2 "	2.25 mm	8 bar	20 bar	-20 - 60 °C	Yellow	50 m	1	034021
HOSE PVC 1" 50M	-	2.9 mm	6 bar	16 bar	-20 - 60 °C	Yellow	50 m	1	052455
PVC Hosepipe for Water	3/4 "	2.6 mm	6 bar	16 bar	-20 - 60 °C	Yellow	50 m	1	034022

AGR: 02.330 / 08.695

Compressed air hose rubber

- Especially robust, durable design, suitable for air, water, waste water and non-aggressive media
- Oil resistance of the core is limited, abrasion resistant cover, aging and weather resistant

Scope Of Delivery

- Complete with compressed air-claw couplings



Title	PU Roll	Article No.
Compressed air hose rubber	1	243468
AGR: 08.695		

Outside hose coupling

- Coupling made out of malleable cast iron according to DIN 3489
- Galvanized and yellow passivated (chrome-V1-free)
- With dual action cam security

Title	For Hose Internal Ø, Inch	PU Piece	Article No.
Outside hose coupling	1/2 "	1	243477
Outside hose coupling	1 "	1	243475
Outside hose coupling	3/4 "	1	243476

AGR: 08.695



Inner hose coupling

- Coupling made out of malleable cast iron according to DIN 3489
- Galvanized and yellow passivated (chrome-V1-free)
- With dual action cam security

Title	For Hose Internal Ø, Inch	PU Piece	Article No.
Inner hose coupling	1/2 "	1	243473
Inner hose coupling	1 "	1	243474
Inner hose coupling	3/4 "	1	243472

AGR: 08.695



Hose coupling

- Coupling made out of malleable cast iron according to DIN 3489
- Galvanized and yellow passivated (chrome-V1-free)
- With dual action cam security

Title	For Hose Internal Ø, Inch	PU Piece	Article No.
Hose coupling	1/2 "	1	243470
Hose coupling	3/4 "	1	243469

AGR: 08.695



Hose clamp compressed air

- Hose clamp mad eout of malleable cast iron
- Galvanized and yellow passivated (chrome-VI-free)
- Two parted with loose tounge



Title	For Hose Internal Ø, Inch	PU Piece	Article No.
Hose clamp compressed air	3/4 "	1	243466

AGR: 08.695

Hose connecting pipe

- Hose connecting pipe out of steel according to DIN 20038
- Galvanized and yellow passivated (chrome-VI-free)



Title	For Hose Internal Ø, Inch	PU Piece	Article No.
Hose connecting pipe	3/4 "	1	243471

AGR: 08.695

Easy Step PREMIUM

- Easy to use.
- Flexible.
- Quality, Sécurité and Design.

Characteristics

- Easy to pull out to the desired length and securing it before use is just as quick. When the red locking catches have unfolded under each rung, this indicates that the ladder is ready for use and can handle loads of up to 150 kg.
- New conception with triangular tube design makes the ladder strong and torsionally rigid and it is easy to push together. Rubber tops, angled and grooved steps also mean that you can feel safe at all times.
- With the minimal turning radius, the ladders are perfect even in small spaces. The ladder can be adjusted to the optimal height to fit your needs precisely.

Hints

- When the red locking catches have unfolded under each rung, this indicates that the ladder is ready for use and can handle loads of up to 150 kg
- Step depth: 50mm

Technical Data

Material	Aluminium
Max load capacity	150 kg



Title	Number of rungs	Length leaning ladder	Width	Weight	PU Piece	Article No.
Easy Step PREMIUM	10	0.8 - 3.2 m	0.47 m	11 kg	1	335300
Easy Step PREMIUM	13	0.89 - 4.1 m	0.47 m	15.2 kg	1	335299

AGR: 08.610

Accessories Available

	PU Amount	Article No.
Pro adjustable safety feet Premium 3,2	1	335519

Spare Parts

	PU Amount	Article No.
Rubber feet 99 mm / 4,1 m	1	335518
Rubber feet Premium 3,2m	1	335517

Accessories telescope premium ladder 3,2 m

- Non-skid feet with adjustable height from 0 to 22 cm
- Ensure perfect support of the ladder against walls or posts (delivered by 2)

Application Area

- Adjustable feet and slip: height adjustable from 0 to 22 cm. Used to position the ladder in a staircase to offset the drop. Ensures perfect support of the ladder against the walls, columns .. (delivered by 2).
- Spikes for safety feet are attached under the feet of safety in case of use of the scale on soft ground.
- Rubber pads: spare parts in case of wear or loss Original skates.



Title	PU Piece	Article No.
Pro adjustable safety feet Premium 3,2	1	335519
Rubber feet 99 mm / 4,1 m	1	335518
Rubber feet Premium 3,2m	1	335517
Ground spike for safety feet Premium 3,2m	1	335516

AGR: 08.610

Aluminium telescope ladder 3.8 m 13 rungs II

- Due to the low weight of approx. 13 kg and yet a maximum length of about 380 cm, the ladder is very easy to transport.
- Individually usable, as the Aluleiter has different lengths
- Can be set
- Large rubberized feet for a safe stand
- When the telescopic ladder is extended, the individual locks sprout themselves and are released again by push of a button
- Tight-proof square profile rungs

Application Area

- This ladder is very suitable everywhere, where little space or storage space is present. Due to their minimum size of approx. 0.9 m, it is also very good in stowing vehicles

Technical Data

Max load capacity	150 kg
-------------------	--------



Title	Number of rungs	Length leaning ladder	Width	Transport Length	Weight	PU Piece	Article No.
Alu-Telescopic Ladder 13 Steps II	13	0.90 - 3.87 m	0.50 m	0.90 m	13 kg	1	332972

AGR: 08.610

Wood step ladder with rungs, double-sided access

- Certified according to Austrian standard Z 1501
- Impregnated
- From 8 rungs it is equipped with rung tighteners
- Main rung in hardwood
- Metal parts fully galvanized
- Made in Austria



Further workshop equipment

Title	Number of rungs	Height double ladder	Transport Length	PU Piece	Article No.
WOOD-STEPLADDERN 3 STEPS	2 x 3	1.10 m	1.10 m	1	245095
WOOD-STEPLADDERN 4 STEPS	2 x 4	1.3 m	1.37 m	1	084242
WOOD-STEPLADDERN 5 STEPS	2 x 5	1.6 m	1.67 m	1	084243
WOOD-STEPLADDERN 6 STEPS	2 x 6	1.9 m	1.97 m	1	084244
WOOD-STEPLADDERN 7 STEPS	2 x 7	2.2 m	2.27 m	1	084245
WOOD-STEPLADDERN 8 STEPS	2 x 8	2.5 m	2.57 m	1	084246
WOOD-STEPLADDERN 9 STEPS	2 x 9	2.9 m	2.97 m	1	084247
WOOD-STEPLADDERN 10 STEPS	2 x 10	3.1 m	3.17 m	1	084248
WOOD-STEPLADDERN 12 STEPS	2 x 12	3.8 m	3.87 m	1	084250
WOOD-STEPLADDERN 14 STEPS	2 x 14	4.40 m	4.40 m	1	245094

AGR: 08.610

Accessories Available

	PU Piece	Article No.
PLASTIC GROUND EXTRA SMOOTH	1	084253
PLASTIC GROUND SMALL 80	1	084252

Wood-Ladder

- Made in Austria
- EN 131-1 certified
- Impregnated
- Rungs in hardwood design
- With a rung tensioner, if there are 17 rungs or more, the holms are additionally glued

Technical Data

Material	Wood
Max load capacity	150 kg
Width	410 mm



Title	Number Of Rungs/Ladder Parts	Length Single Ladder	PU Piece	Article No.
Wood-Ladder	5	1.40 m	1	245127

AGR: 08.610

Extension for wood ladder 3-9 sprouts

- Content: 2 rail extensions made of wood and 4 metal clamps, 2 of them adjustable with adjustment screw



Title	PU Paar	Article No.
Extension for wood ladder 3-9 sprouts AGR: 08.610	1	363373

Plastic support foot

Hints

- For ladders starting at 4 rungs

Title	PU Piece	Article No.
PLASTIC GROUND EXTRA SMOOTH	1	084253
PLASTIC GROUND SMALL 80	1	084252

AGR: 08.610



Flanged stepladder

- Allows good user positioning
 - ▶ 2 side walk stepladder
 - ▶ Bottom width of 430 mm (2x3) and 480 mm (2x5)
- Secure
 - ▶ Closure guide (clamping) on the bars
 - ▶ High-strength belts to prevent spacing
 - ▶ 80 mm non-skid steps
 - ▶ Non-slip rubber feet screwed in the ladder jamb - thus easily replaceable
- Robust
 - ▶ Strong cast aluminum joints
 - ▶ Profiles 70 mm
- Tested in accordance with DIN EN 131, TÜV / GS

Technical Data

Max load capacity	150 kg
-------------------	--------



Title	Number of rungs	Transport Length	Weight	PU Piece	Article No.
Flanged stepladder	2 x 3	0.7 m	5.1 kg	1	210760
Flanged stepladder	2 x 5	1.17 m	8 kg	1	210759

AGR: 08.610

Berner Folding Steps 6 Functions

- Versatile: 6 Integrated functions in one single product.
- Easy handling, rapid to use and adaptable for an effective work.
- Lightweight and compact for transport and storage.
- Solid profiles thanks to its anodized aluminum and bi-material articulations.
- Stable with a ground clearance of 0.70 x 0.70 m unfolded.
- Secure: protection railing height 440 mm.

Characteristics

- Conforms to European standard EN 14-183.
- 2 years warranty. * Against manufacturing and materials defects for parts in aluminum and steel.

Processing Information

- 1F: Position Step ladder with height access to 2.50 m.
- 2F: Bridge position for cutting large sections (Wood, PVC).
- 3F: Trestles position for cutting intermediate sections (Wood, PVC).
- 4F: Practical easy quick clamps position to cut small section (threaded rods, copper pipes ...).
- 5F: Ergonomic workbench position for working (0.9 m above the floor).
- 6F: Position cutting table (0.7 m above the floor).

Hints

- Dimensions, folded (height x width x depth): 1.04 x 0.70 x 0.09 m
- Conforms to European standard EN 14-183
- 2 year warranty on manufacturing and material defects for parts in aluminum and steel

Technical Data



Further workshop equipment

Max load capacity

150 kg



Title	Number of rungs	platform height	Weight	PU Piece	Article No.
6 Functions Berner Stepladder	2	0.5 m	10 kg	1	333747

AGR: 08.610

ALU-Safety Runway

- Non-slip profile on the running platform
- With tread plate profile on the steps
- Double-sided to step on
- With large platform for secure stand
- With safety locks for the steps
- Foldable and therefore space saving
- Plastic edges at feet protect the platform and the floor
- Stirrups and steps made of aluminum
- Solid aluminum construction
- Platform size 960 x 300 mm



Technical Data

Material	Aluminium
Max load capacity	150 kg

Title	Number of rungs	Width	platform height	Transport Length	Weight	PU Set	Article No.
ALU-Safety Runway	1	300 mm	0.49 m	0.96 m	7300 g	1	051217

AGR: 08.192

Telescopic ladder **TOPline**

- Adapted for professional users
 - ▶ Strong and compact for transport, with double telescopic function
 - ▶ Can be used as auto-stable stepladder, even on stairs, and as a single and a double ladder
 - ▶ Recommended model for maintenance work and finishing, decoration, painting
 - ▶ Heavy duty profiles (70x31 mm external / 63x27 mm internal)
 - ▶ 5 year warranty (on defects related to workmanship and aluminium and steel parts)
- Maximum security
 - ▶ Ergonomic rubber feet for maximum grip
 - ▶ Full aluminium hinges (3 steel pins) with double positioning system (locked or let free)

Hints

- Optionnal stabilizer under-bar available separatly

Technical Data

Material	Aluminium
Max load capacity	150 kg



Title	Number of rungs	Height double ladder	Transport Length	Weight	PU Piece	Article No.
Telescopic sliding ladder 4x4 (8+8)	4 x 4	1.91 - 4.01 m	1.22 m	12 kg	1	368906
Telescopic sliding ladder 4x5 (10+10)	4 x 5	2.44 - 5.15 m	1.50 m	14.2 kg	1	368907

AGR: 08.610

INTERNAL/Approved (2019-03-23 00:55:50)

Wall and Top Cabinet

- Removable middle partition wall for storing extremely bulky tools

Application Area

- Can be used as a wall cabinet or top cabinet

Characteristics

- Sturdy tool cabinet made of sheet steel
- 2-door, with perforated plate on all side walls, rear walls and door panels
- Used as an attachment for rolling workbench "Evolution" or as a wall cabinet
- Perforated metal for use of the holder no. 1, 3, 4 and 8
- When used as a top cabinet, it is recommended to take conventional wood screws (6x20) with washers and screw through the designated punched with the worktop. Wood screws are not included

Scope Of Delivery

- 2 individually adjustable shelves

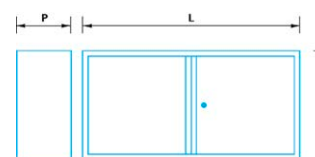

Title	Height x width x depth	PU Piece	Article No.
Wall and Top Cabinet	600 x 1200 x 300 mm	1	141710

AGR: 08.110

Holder-Assortment, 10 Part

Application Area

- For cutting discs and grinding wheels

Characteristics

- Suitable for heavy loads

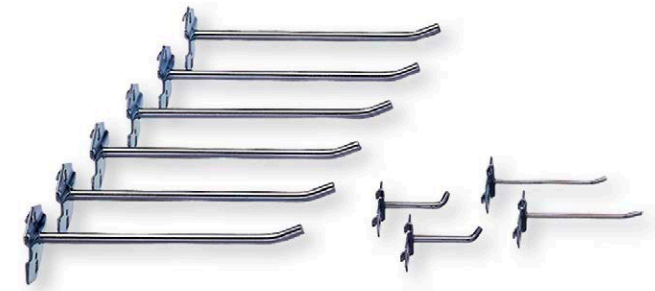

Title	PU Piece	Article No.
Holder-Assortment, 10 Parts	1	343013
AGR: 07.110		
Scope Of Supply	Piece	Article No.
Holder 1/100 with hooks	2	203661
Holder 1 / 200 with hooks	6	265136
Holder 1/50 with hooks	2	194913

"Evolution" Rolling Workbench

Scope Of Delivery

- Rolling workbench without top cabinet

Title	Height x width x depth	Weight kg	PU Piece	Article No.
"Evolution" Rolling Workbench	925 x 1200 x 600 mm	68 kg	1	141709

AGR: 08.102



Spare parts for mobile workbench.

Hints

- Directional wheel with brake replacement maid revolution is compatible.

Title	PU Paar	Article No.
Pair of rails for narrow drawers	1	060118
Pair of rails for wide drawers	1	060119

AGR: 08.100



Accessories for "Evolution" Rolling Workbench

Characteristics

- Bera assortments can be housed in pairs in the drawers

Hints

- One inlet fits in one BS-basic box
- Two inlets fit in one Bera module shelf drawer

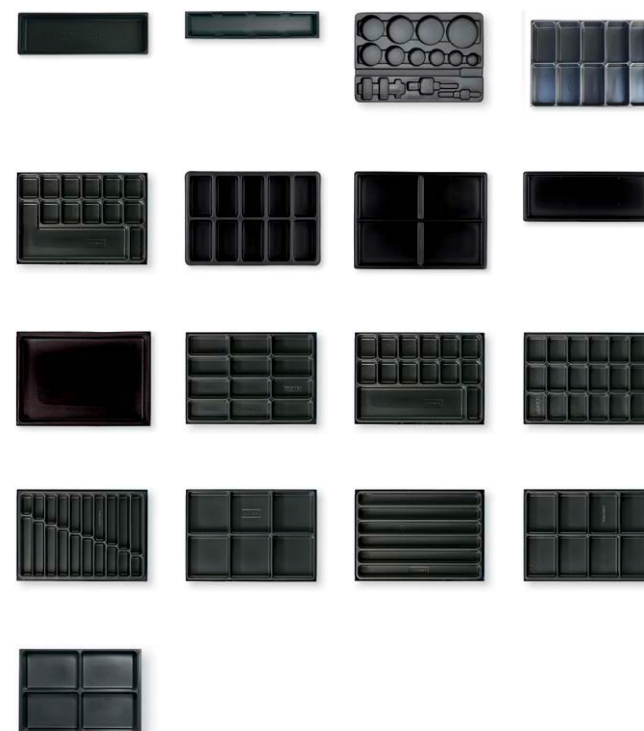

Further workshop equipment

Title	Subjects, Number	Height, External	External Width	Depth, Exterior	PU Piece	Article No.
SPACER EMPTY 340X65X30	-	51 mm	325 mm	70 mm	1	041508
Plastic inlets	4 PC	50 mm	325 mm	225 mm	1	007148
Square plastic	6 PC	50 mm	325 mm	225 mm	1	317241
Plastic inlets	6 PC	50 mm	325 mm	225 mm	1	278904
Plastic inlets	8 PC	50 mm	325 mm	225 mm	1	024198
BERA plastic insert tray 10 cavities	10 PC	50 mm	325 mm	225 mm	1	912181
Plastic inlets	12 PC	50 mm	325 mm	225 mm	1	234800
Plastic inlets	14 PC	50 mm	325 mm	225 mm	1	232815
Plastic inlets	18 PC	50 mm	325 mm	225 mm	1	232807
Plastic inlets	20 PC	50 mm	325 mm	225 mm	1	232823

AGR: 07.955 / 08.104

Cross and lengthwise dividers

Characteristics

- Cross and lengthwise dividers for the drawers can be retrofitted without problems

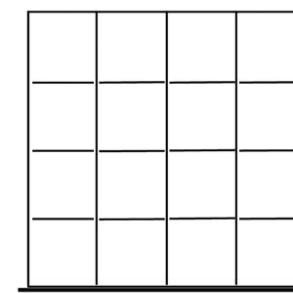
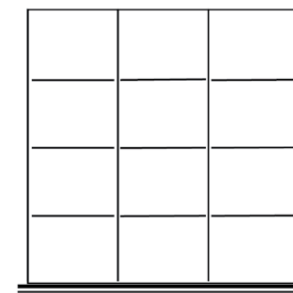
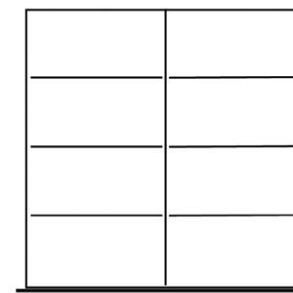

16

Title	Longitudinal Divider, Quantity	Cross Divider, Quantity	PU Piece	Article No.
Drawer Divider Set 8 way	1 PC	6 PC	1	141711

AGR: 08.102

"Compact 8266" Workbench

Characteristics

- Worktop is made from 40 mm thick, multilayered glued beechwood, foot stand U-profile 75 x 50 mm, with floor plates for floor mounting, cabinet and draw can be locked, with ample storage space behind the hinged door that is divided by 2 removable shelves, drawers move smoothly even with a full load

Title	Height x width x depth	Weight kg	PU Piece	Article No.
Compact 8266	840 x 1500 x 700 mm	75 kg	1	428266

AGR: 08.102



"Compact 8267" Workbench

Characteristics

- Worktop is made from 40 mm thick, multilayered glued beechwood, foot stand U-profile 75 x 50 mm, with floor plates for floor mounting, cabinet and draw can be locked, with ample storage space behind the hinged door that is divided by 2 removable shelves, drawers move smoothly even with a full load

Title	Height x width x depth	Weight kg	PU Piece	Article No.
"Compact 8267" Workbench	840 x 2000 x 700 mm	115 kg	1	108876

AGR: 08.102



Folding Work Bench

- Wooden worktop with metal guards around all the edges
- Weather-resistant, non-warping
- Collapsible frame underneath
- Stable and with load-bearing capability
- Flat surfaces
- 30 mm thick wooden worktop

Application Area

- For use in highly demanding conditions on building sites and in workshops



Title	Height x width x depth	Weight kg	PU Piece	Article No.
FOLDING WORKBENCH 1000X700MM	700 x 1000 x 700 mm	3.1 kg	1	110586

AGR: 08.102

Foldable Support Block

- Practical and saves space as it can be folded
- Stable, max. load 100 kg per support block
- Safe operation due to slip-proof support
- Saves time due to easy operation

Title	Height x width x depth	PU Paar	Article No.
Foldable Support Block	800 x 1000 x 85 mm	1	138767

AGR: 08.009



Folding trestle wood 90 cm

- Made in Austria

Hints

- Not verified
- Not impregnated

Title	PU Piece	Article No.
FOLDING TRESTLE 90 CM	1	084251

AGR: 08.610



124 Delivery Table "ASSO"

Application Area

- Robust delivery table for large-dimensioned front shields

Characteristics

- The fastening chains guarantee a maximal opening of the bracket of 1000 mm, the delivery arms are equipped with a soft rubber guard, the device will be installed and is ready for use

Title	PU Piece	Article No.
124 SET/DOWN TABLE "ASSO"	1	148193

AGR: 08.193



Rolling Seat – Car Creeper

- Fully upholstered lying area for comfortable use
- Movable support parts and lever operation for easy changeover from the lying to the sitting position
- Lightweight and safe stand due to stable steel construction
- Effortless movement due to 7 steering castors
- Practical tool storage
- Load capacity: about 200 kg

Application Area

- Working underneath vehicles or working in a comfortably seated position
- Suitable as a rolling seat for work at knee level due to the ergonomically suited seating height of 450 mm, e.g. for bodywork
- Suitable as a dolly for working on floor level due to low height of just 90 mm, e.g. for repairs underneath the vehicle

Characteristics

- Color: Blue, weight: 11 kg, easy-to-clean surface
- Length: 1250 mm Width: 450 mm Height: 150 mm

Technical Data

Material	Metal
Surface protection	painted
Weight	11 kg
Bearing Load, Max.	200 kg



Title	Height	Length	Width	PU Piece	Article No.
Rolling seat / dolly	150 mm	1250 mm	450 mm	1	157027

AGR: 08.190

Spare Parts

	PU Piece	Article No.
Wheel for car-creeper	1	014277
REPL.WH F.ROLL SEAT-ROLL.BOARD	1	158907

INTERNAL/Approved (2019-03-23 00:57:20)

Further workshop equipment

Rolling workstool

- 5 rolls with the Ø of 60 mm for stable standing

Application Area

- For comfortable sitting at the workplace

Technical Data

Weight	6 kg
Bearing Load, Max.	150 kg
Base Plate, Width	400 mm

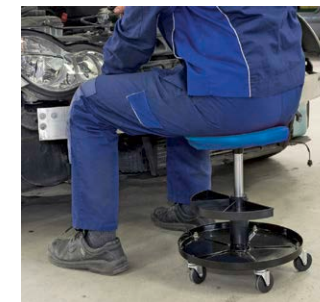

Title	Ø	Height	Height, Max.	PU Piece	Article No.
WORK SEAT 5 WHEEL	320 mm	380 mm	510 mm	1	184119

AGR: 08.191

Spare Parts

	PU Piece	Article No.
SPARE PART WHEEL FOR SEAT	1	184311

Work Roll Chair Premium

- Very robust work stool made of welded metal base
- 4 large ball bearing casters for easy maneuvering
- Large storage compartment for tools or materials
- Ideally suited for working on axles, brakes or the like

Application Area

- Working in sitting position on the vehicle

Title	PU Piece	Article No.
Work Roll Chair Premium	1	336396

AGR: 08.191

PU **Article No.**
Amount

1	336397
---	--------



Roll couch HD creeper

- Expanded swivel castor for improved sturdiness.
- Ergonomically shaped, without stress on the shoulders and arm.
- Concave tablets for depositing small parts, one on each side.
- 6 castors: quite silent movements, oil resistant.
- Headrest: soft and padded.
- With carrying handle.

Application Area

- For operations under vehicles.

Technical Data

Bearing Load, Max. 130 kg



Title	Height	Length	Width	PU Piece	Article No.
Roll couch HD creeper	90 mm	1000 mm	475 mm	1	336206

AGR: 08.190

Spare Parts

	PU Amount	Article No.
REPL.ROLLS FOR ROLLCOUCH PREM	1	186085

INTERNAL/Approved (2019-03-23 00:57:44)

Further workshop equipment

Racing Creeper 6 Wheel

- Large laying area
- Ergonomically shaped upholstery on the back and head area
- Lateral storage space for tools or materials, as well as storage facilities for e.g. Lamps on the headboard
- 6 large, ball bearing castors for easy maneuvering even on uneven ground
- Wide cut-out in the shoulder area for a lot of freedom of movement
- Honeycomb structure for high stability



Application Area

- Working in a lying position, e.g. Under vehicles

Title	Length	Length x width	External Width	Total Height	PU Piece	Article No.
Racing Creeper 6 Wheel	1045 mm	1045 x 517 mm	517 mm	90 mm	1	336395

AGR: 08.190

Spare Parts

	PU Amount	Article No.
Spare Wheel for Racing Creeper	1	336394

Safety Assembly Steps

- No tilting because of inclined feet, grid according to DIN 50976 which is non-slip, galvanised and riveted with the frame
- Approved by the German employer's liability insurance coverage ZH 1/454 Ziff. 4.6.6+5.6.4

Title	Length x width	Total Height	PU Piece	Article No.
SAFETY-ASSY. STEPS	620 x 690 mm	450 mm	1	162586

AGR: 08.192



Bench Vice

- Burnished thread-keay
- Hardened and knurled jaws
- Polished surface
- Hardened anvil
- Adjusting screws
- Hardened pipe clamping jaws

Characteristics

- Made from forged steel
- Surface hardened with big anvil
- precision guidance with forced blocking

Scope Of Delivery

- The vise is supplied without a rotary plate

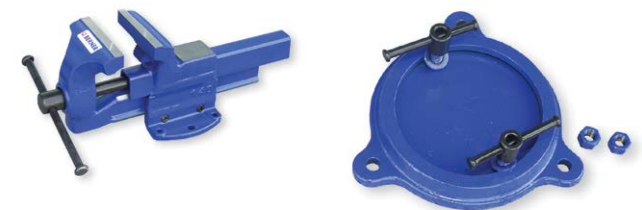
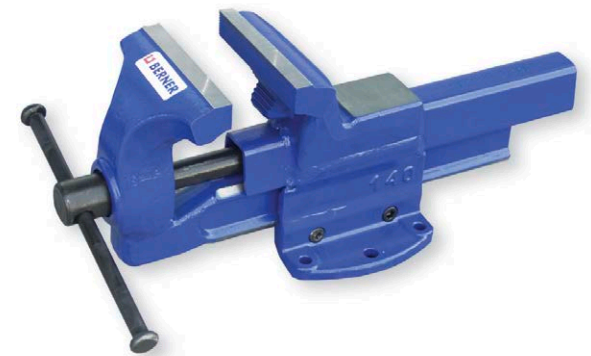
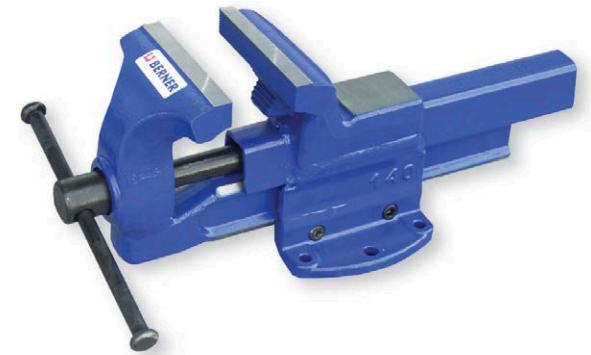

Fixing Jaw Aluminium

- Sizes from 115 mm to 150 mm
- To clamp coarse and medium-fine work pieces
- Profile consists of special alloyed aluminium with a degree of hardness which lies between copper and lead
- 6 linear grooves ensure the safe clamping of uneven work pieces, one deeper milled groove absorbs round pieces



Title	External Width	PU Piece	Article No.
MAGN-FIXING JAWS ALU 115 PAIR	115 mm	1	853390
MAGN-FIXING JAWS ALU 135 PAIR	135 mm	1	853383
MAGN-FIXING JAWS ALU 150 PAIR	150 mm	1	853376

AGR: 03.605

Protective Jaw Set

- 4 models solve all problems with clamping in bench and machine vices, e. g. with conical bolts or thin walled pipes
- Consist of a strong aluminium profile in an alloy, of which hardness lies between that of copper and lead
- The prism jaws are produced from an annealed aluminium
- The prisms are rectangular and coplanar and fit in every vice, even in machine vices and they are suitable for production and mounting
- Inserted special magnets cling the braces to the vice and they are only magnetic to the vice. Filings do not stick, and the fixed pieces are not magnetised

Scope Of Delivery

- Pairwise braces

Title	External Width	PU Set	Article No.
MAGNEFIX JAW SET 140MM	140 mm	1	018487

AGR: 03.605



Protective Jaw Set

- Implementation for jaw width 140 mm
- For clamping in of coarse to medium-fine pieces
- The profile consists out of a specially alloyed aluminium with a degree of hardness which lies between copper and lead
- 6 linear grooves ensure a safe clamping of irregular workshops and a secure clamping of irregular work pieces, a deep milled groove takes in round pieces

Scope Of Delivery

- In pairs



Title	Jaw Width	PU Paar	Article No.
MAGNEFIX BRACES TYPE N	140 mm	1	026973

AGR: 03.605

Protective Jaw P

- Implementation for jaw width 140 mm
- Prism jaw and pipe jaw out of hardened aluminium
- The jaws are equipped with a 120° horizontal and three 12° vertical millings
- The jaws have a 90° profile for horizontal work, for example scribing, punching. If a block is clamped in, the vice can serve as a structure plan for lighter work
- Only one jaw is being used during thread cutting (The vice should be positioned as a counterholder, which prevents twisting of the workpiece, that can damage the jaw)

Scope Of Delivery

- In pairs



Title	Jaw Width	PU Paar	Article No.
MAGNEFIX BRACES TYPE P	140 mm	1	026972

AGR: 03.605

INTERNAL/Approved (2019-03-23 00:58:25)

Further workshop equipment

Protective Jaw PPU

- Implementation for jaw width 140 mm
- For bar-shaped parts with highly sensitive details
- Out of polyurethane with a hardness of Shore A82 (polyurethane is known for its resilience)
- Equipped with a prismatic recesses, vertical and horizontal
- The polyurethan shapes around the details as e.g. threads, grooves or engravings, without damaging them

Scope Of Delivery

- In pairs

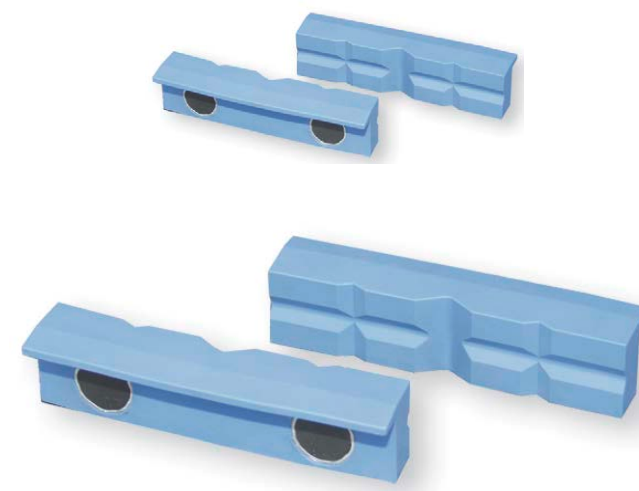

Title	Jaw Width	PU Paar	Article No.
MAGNEFIX BRACES TYPE PUP	140 mm	1	026970

AGR: 03.605

Protective Jaw PUF

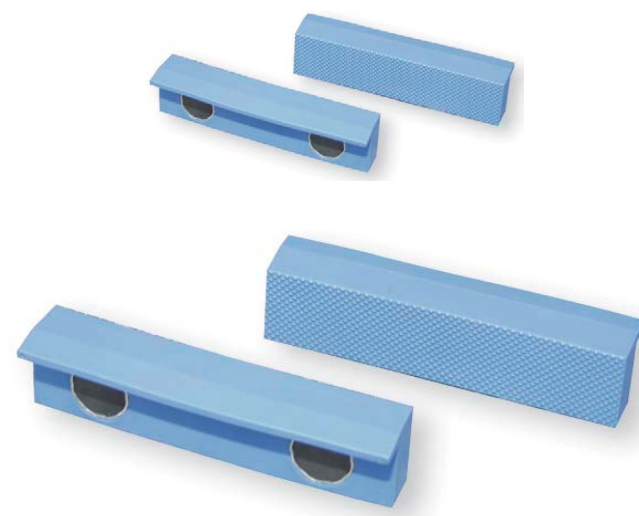

Title	Jaw Width	PU Paar	Article No.
MAGNEFIX BRACES TYPE PUF	140 mm	1	026971

AGR: 03.605

Hoisting Slings

- Approved by the respective professional association for all modes of assembly
- Color-coded according to bearing capacity
- Additionally woven-in tons straps for optimal safety



Application Area

- Lifting and securing of goods and tools

Characteristics

- Durable polyester (PES) belt loops with additionally reinforced end straps, safety factor 7:1, GS-tested (Safety Tested) according to EN 1492-1, CE mark, German brand quality

Title	Permitted tensile force	Permissible Carrying Capacity(U-Shape)	Length (m)	Total Width	Color	PU Piece	Article No.
Hoisting Slings	1000 daN	2000 daN	2 m	30 mm	Purple	1	055421
Hoisting Slings	1000 daN	2000 daN	3 m	30 mm	Purple	1	109124
Hoisting Slings	1000 daN	2000 daN	4 m	30 mm	Purple	1	055422
Hoisting Slings	1000 daN	2000 daN	5 m	30 mm	Purple	1	109119
Hoisting Slings	1000 daN	2000 daN	6 m	30 mm	Purple	1	200841
Hoisting Slings	2000 daN	4000 daN	2 m	60 mm	Green	1	200842
Hoisting Slings	2000 daN	4000 daN	4 m	60 mm	Green	1	055423
Hoisting Slings	2000 daN	4000 daN	6 m	60 mm	Green	1	055425
Hoisting Slings	3000 daN	6000 daN	2 m	90 mm	Yellow	1	200843
Hoisting Slings	3000 daN	6000 daN	4 m	90 mm	Yellow	1	055424
Hoisting Slings	3000 daN	6000 daN	6 m	90 mm	Yellow	1	055426

AGR: 08.900 / 08.901

Round Slings

- Impregnated and wear-resistant protective shell for an enhanced lifetime
- Color-coded according to load capacity
- Additionally woven-in tons straps and load capacity print for optimal safety



Application Area

- Hoisting and securing of goods and tools

INTERNAL/Approved (2019-03-23 00:58:44)

Further workshop equipment

Characteristics

- With single coat made of durable polyester (PES), safety factor of 7:1, GS-tested (Safety Tested) according to EN 1492-2, CE symbol, German brand quality

Hints

- The length indicated in the table is the perimeter. In order to obtain the usage dimension length L1, the perimeter is to be halved.

Title	Permitted tensile force	Permissible Carrying Capacity(U-Shape)	Useable Length	Length (m)	Color	PU Piece	Article No.
Round Sling	1000 daN	2000 daN	0.5 m	1 m	Purple	1	216420
Round Sling	1000 daN	2000 daN	1 m	2 m	Purple	1	055427
Round Sling	1000 daN	2000 daN	1.5 m	3 m	Purple	1	059612
Round Sling	1000 daN	2000 daN	2 m	4 m	Purple	1	055429
Round Sling	1000 daN	2000 daN	2.5 m	5 m	Purple	1	216421
Round Sling	1000 daN	2000 daN	3 m	6 m	Purple	1	200844
Round Sling	1000 daN	2000 daN	4 m	8 m	Purple	1	059611
Round Sling	2000 daN	4000 daN	0.5 m	1 m	Green	1	216422
Round Sling	2000 daN	4000 daN	1 m	2 m	Green	1	216419
Round Sling	2000 daN	4000 daN	1.5 m	3 m	Green	1	055428
Round Sling	2000 daN	4000 daN	2 m	4 m	Green	1	055430
Round Sling	2000 daN	4000 daN	2.5 m	5 m	Green	1	216418
Round Sling	2000 daN	4000 daN	3 m	6 m	Green	1	200845
Round Sling	2000 daN	4000 daN	4 m	8 m	Green	1	216417
Round Sling	3000 daN	6000 daN	0.5 m	1 m	Yellow	1	216416
Round Sling	3000 daN	6000 daN	1 m	2 m	Yellow	1	216415
Round Sling	3000 daN	6000 daN	1.5 m	3 m	Yellow	1	216414
Round Sling	3000 daN	6000 daN	2 m	4 m	Yellow	1	055431
Round Sling	3000 daN	6000 daN	2.5 m	5 m	Yellow	1	216413
Round Sling	3000 daN	6000 daN	3 m	6 m	Yellow	1	055432
Round Sling	3000 daN	6000 daN	4 m	8 m	Yellow	1	059691
Round Sling	4000 daN	8000 daN	1 m	2 m	Grey	1	216412
Round Sling	4000 daN	8000 daN	1.5 m	3 m	Grey	1	216411
Round Sling	4000 daN	8000 daN	2 m	4 m	Grey	1	216409
Round Sling	4000 daN	8000 daN	2.5 m	5 m	Grey	1	216408
Round Sling	4000 daN	8000 daN	3 m	6 m	Grey	1	216407

Title	Permitted tensile force	Permissible Carrying Capacity(U-Shape)	Useable Length	Length (m)	Color	PU Piece	Article No.
Round Sling	4000 daN	8000 daN	4 m	8 m	Grey	1	216405
Round Sling	4000 daN	8000 daN	5 m	10 m	Grey	1	216406

AGR: 08.901

Round Slings

- With an impregnated and abrasion-proof protective coat for a long lifetime
- Color-coded according to carrying capacity as well as additional woven tonnage stripes and a load capacity imprint



Characteristics

- • double coating out of resistant polyester(PES)
- • Safety factor 7:1, GS-sign, CE-sign
- • according to DIN V 61360

Title	Permitted tensile force	Permissible Carrying Capacity(U-Shape)	Useable Length	Length (m)	Color	PU Piece	Article No.
Round Slings	1000 daN	2000 daN	1 m	2 m	Purple [2]	1	151799
Round Slings	1000 daN	2000 daN	1.5 m	3 m	Purple [2]	1	109125
Round Slings	1000 daN	2000 daN	2 m	4 m	Purple [2]	1	151800
Round Slings	2000 daN	4000 daN	2 m	4 m	Green	1	151801
Round Slings	2000 daN	4000 daN	3 m	6 m	Green	1	151802
Round Slings	3000 daN	6000 daN	2 m	4 m	Yellow	1	109031
Round Slings	3000 daN	6000 daN	3 m	6 m	Yellow	1	151803
Round Slings	3000 daN	6000 daN	4 m	8 m	Yellow	1	151804

AGR: 08.901

One Way Round Sling

Characteristics

- Safety factor 1 : 5,
- Minimum breaking force is equivalent to the quintuple load capacity

Hints

- Color of sling 500 mm black
- Color of sling 1000 mm white
- Color may slightly differ from the picture

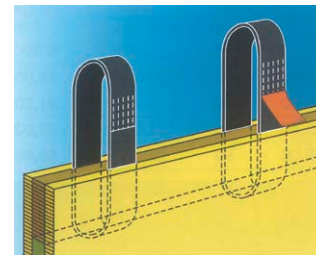

Title	Permissible Carrying Capacity (Sling)	Total Width	Color	PU Piece	Article No.
One Way Round Sling	730 daN	50 mm	black	90	151654
One Way Round Sling	1400 daN	50 mm	White	100	248620

AGR: 08.901

Edge Protector

- Protective hose from PVC-coated tissue material

Application Area

- Protects the tension belt from rubbing



Title	Length	Length x width	External Width	PU Piece	Article No.
EDGE PROTECTOR CT 50 AGR: 08.900	500 mm	500 x 50 mm	50 mm	1	109122

Further workshop equipment

Strip Protector

- Protection of the corners against large cargo of various size and quality
- Suitable for different forms of load
- Specially tested rubber coating
- Resistent against deformation and low or high temperature fluctuations
- Strap schooner PPCA with item number 248602, has a special cut in the middle of the strap. This enables attaching the strap to a pre-existing one.



Title	Length x total width	Color	PU Piece	Article No.
Edge Protection Profile	100 x 290 mm	black	1	248601
Edge Protection Profile	100 x 290 mm	black	1	248602

AGR: 08.900

Transport Belt Block

- For a fully stable mounting of the cargo
- No deformation through high or low outside temperatures
- Resists against a pressure of a few hundred kilograms



Title	Length x total width	Color	PU Piece	Article No.
Edge Protection Profile	40 x 100 mm	black	1	248600

AGR: 08.900

Edge Protection Profile

- Reliable protection of lashing straps or bundling ties
- Distribution of the clamping pressure in a beneficial ratio through wide surface
- Withstands a pressure of hundreds of kilogram
- Resistant against all weather conditions
- Lateral stop prevents shifting of the strap

Application Area

- Perfect edge securing for all kind of sensitive and fragile transported goods
- for smaller loads
- Special form for a better protection of the edges of the cargo



INTERNAL/Approved (2019-03-23 00:59:52)

Title	Length x total width	Color	PU Piece	Article No.
-------	----------------------	-------	----------	-------------

Edge Protection Profile

- Reliable protection of lashing straps or bundling ties
- Distribution of the clamping pressure in a beneficial ratio through wide surface
- Lateral stop prevents shifting of the strap
- CE-certified
- Break-proof

Application Area

- Perfect edge securing for all kind of sensitive and fragile transported goods

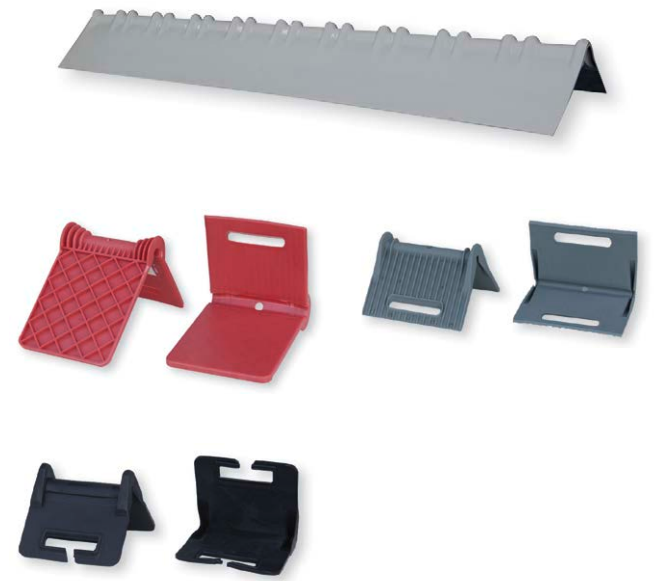

Title	Length x total width	Color	PU Piece	Article No.
Edge Protection Profile AGR: 08.900	175 x 1200 mm	White	1	248604

Edge Protection Profile

- Reliable protection of lashing straps or bundling ties
- Distribution of the clamping pressure in a beneficial ratio through wide surface
- break-proof
- Lateral stop prevents shifting of the strap
- Resistant against all weather conditions

Application Area

- Perfect edge securing for all kind of sensitive and fragile transported goods
- Especially suitable for smaller loads



Title	Length x total width	Color	PU Piece	Article No.
Edge Protection Profile	100 x 130 mm	Red	1	248603
Edge Protection Profile	100 x 130 mm	black	1	248613

AGR: 08.900

Edge Protection Profile

- Reliable protection of lashing straps or bundling ties
- Distribution of the clamping pressure in a beneficial ratio through wide surface
- Protects the corners against cargo
- Break-proof
- Lateral stop prevents shifting of the strap
- Resistant against all weather conditions

Application Area

- Perfect edge securing for all kind of sensitive and fragile transported goods
- Edge protection protects especially the lashing strap and sensitive products. Not suitable for palletized cargo and bulk materials. Particularly suitable for sensitive products like rolled goods, barrels, plasterboard or chipboards
- Permanently resistant



Title	Length x total width	Color	PU Piece	Article No.
Edge Protection Profile AGR: 08.900	160 x 210 mm	black	1	248609

Edge Protection Profile

- Reliable protection of lashing straps or bundling ties
- Distribution of the clamping pressure in a beneficial ratio through wide surface
- Patented
- Ce certified for idustry
- Lateral stop prevents shifting of the strap

Application Area

- Perfect edge securing for all kind of sensitive and fragile transported goods
- Edge protection protects especially the lashing strap and sensitive products. Not suitable for palletized cargo and bulk materials. Particularly suitable for sensitive products like rolled goods, barrels, plasterboard or chipboards
- Eco version of the edge protector KPDL



INTERNAL/Approved (2019-03-23 01:00:30)

Title	Length x total width	Color	PU Piece	Article No.
Edge Protection Profile	160 x 210 mm	Red	1	248607
Edge Protection Profile	160 x 210 mm	black	1	248608

AGR: 08.900

Edge Protection Profile

- Reliable protection of lashing straps or bundling ties
- Distribution of the clamping pressure in a beneficial ratio through wide surface
- Withstands a load of hundreds of kilogram
- Lateral stop prevents shifting of the strap

Application Area

- Perfect edge securing for all kind of sensitive and fragile transported goods

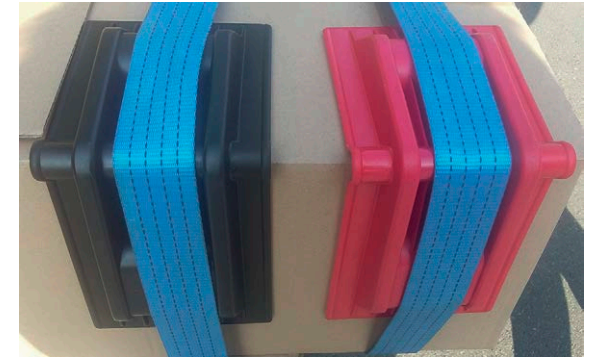

Title	Length x total width	Color	PU Piece	Article No.
Edge Protection Profile	160 x 230 mm	Red	1	248605
Edge Protection Profile	160 x 230 mm	black	1	248606

AGR: 08.900

Aluminum Clamping Bar

Application Area

- Securing of goods on the loading area
- Combination with barrier nets or frames

Characteristics

- Pipes made of high-quality aluminum with solid anti-slip rubber feet on both sides, stageless quick adjustment up to 15°, crepe rubber disks, safe release of the inclination of the pressed-on parts of spread mechanism



Title	Clamping range	Chain nominal thickness	PU Piece	Article No.
Clamping bar	2.26 - 2.63 m	38 mm	1	055434

AGR: 08.900

Partition Locking Device

Application Area

- Securing of goods at the platform gate

Characteristics

- Extractable aluminum profile with 2 locking devices



Title	Clamping range	PU Piece	Article No.
Partition Locking Device	2.40 - 2.70 m	1	055433

AGR: 08.900

Lashing Chain with Separate Tensioning Chain

Application Area

- Securing of heavy loads

Characteristics

- Ratched load clamping fixture with separate chain, quality class 8, reliable traction force (daN) with direct traction, manufactured in accordance with DIN EN 12195-3



Title	Permitted tensile force	Length total (mm)	Chain nominal thickness	Tension Distance	Tensioner Closed	PU Piece	Article No.
Lashing Chain	6300 daN	3500 mm	10 mm	140 mm	610 mm	1	055436*
Lashing Chain	4000 daN	3500 mm	8 mm	155 mm	560 mm	1	055435*

* = The delivery time is 35 days

AGR: 08.900

INTERNAL/Approved (2019-03-23 01:00:44)

Further workshop equipment

Container Mesh

- Simple operation provides maximum security
- High quality of polypropylene multifilament (PPM) technology ensures long service life

Application Area

- Covering full containers, tipping containers and trucks



Title	Length x total width	Mesh Size	Chain nominal thickness	Color	PU Amount	Article No.
Container Net	5 x 3.5 m	45 mm	3 mm	Green	1	055439
Container Net	6 x 3.5 m	45 mm	3 mm	Green	1	167690
Container Net	7 x 3.5 m	45 mm	3 mm	Green	1	055440
Container Net	8 x 3.5 m	45 mm	3 mm	Green	1	201020

AGR: 08.900

Cover Nets for Transporters

- Easy usage
- High-quality polypropylene-multifilament (PPM) guarantees an enhanced lifetime
- Knotless version

Application Area

- Covering of loading areas where vans and car drawn trailers

Hints

- Without rubber border strip

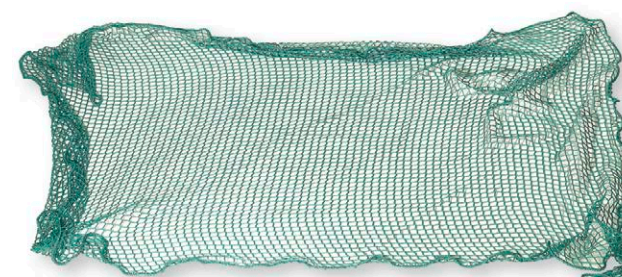

Title	Length x total width	Mesh Size	Chain nominal thickness	Color	PU Piece	Article No.
Cover Net for Transporters	2.5 x 3.5 m	35 mm	3 mm	Green	1	052957
Cover Net for Transporters	2.5 x 4 m	35 mm	3 mm	Green	1	052956
Cover Net for Transporters	2.5 x 4.5 m	35 mm	3 mm	Green	1	052958

AGR: 08.900

Expander Rope

Application Area

- Fixing of truck canvases

Characteristics

- Rubber version
- color: gray

Technical Data

Material Rubber

Title	Rope Length	Diameter (D) In Mm	Color	PU Ring	Article No.
Expander Rope	100 m	8 mm	Grey	1	110350

AGR: 16.612



Ring Hook

Application Area

- Fixing of truck canvases

Characteristics

- Hot-dip galvanized, with bore holes for countersunk screws

Technical Data

Material	Steel
Surface protection	hot dip galvanized

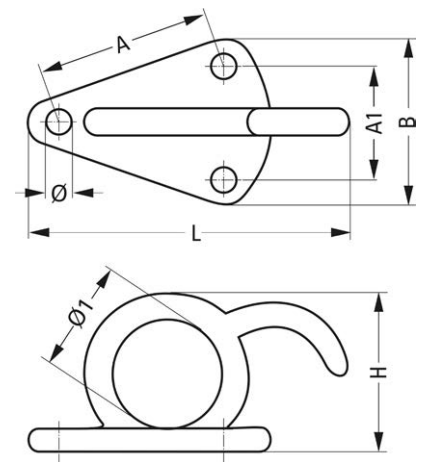

16

Title	Total Height	Width	Length	Hole Distance (A) In Mm	Hole Distance (A1) In Mm	Bef-Hole Diameter	Implementation-Ø (Ø1)	PU Piece	Article No.
Ring Hook	31 mm	45 mm	69 mm	34 mm	31 mm	5.3 mm	19 mm	25	366390

AGR: 16.611

Three Hole Canvas Hook

Application Area

- Fixing of truck canvases up to a rope diameter of 9 mm

Characteristics

- Hot-dip galvanized, small version, with bore holes for countersunk screws

Technical Data

Material	Steel
Surface protection	hot dip galvanized

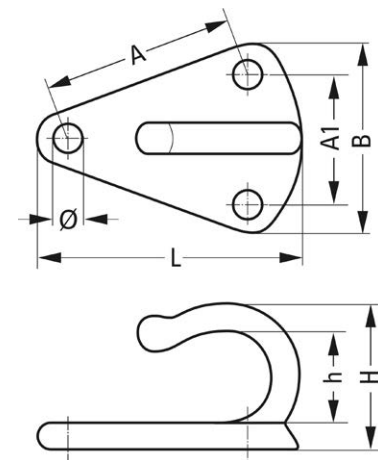

Title	Clear Height (H) In Mm	Total Height	Width	Length	Hole Distance (A) In Mm	Hole Distance (A1) In Mm	Bef-Hole Diameter	PU Piece	Article No.
Three Hole Canvas Hook	13 mm	24.5 mm	40 mm	50 mm	34 mm	28 mm	5.3 mm	25	110342

AGR: 16.611

Further workshop equipment

Anti-Slip Mat

- Enhanced level of protection and safety thanks to anti-slip effect.
- Better stability and safety
- Individual formats by means of own cuttings
- Reduction of the required lashing material as well as of the approved traction force
- Multiply reusable

Characteristics

- Rubber granules with a special, non-slip surface
Grater value 0.6 μ



Title	Length x total width	Chain nominal thickness	Color	PU Roll	Article No.
Anti-Slip Mat	5000 x 250 mm	8 mm	black	1	055441

AGR: 08.900

Anti-Grind-Matt

- Due to the use of a anti-slip mat the friction coefficient between the material and the underfloor is increased, higher security during transportation
- less tension belts are needed
- sizes are matched with the sizes of transport pallets



Application Area

- Load securing
- Storage of smooth or slippery materials



Title	Length	External Width	Total height	Color	PU Piece	Article No.
Anti-Slip Mat 61x122 cm	1220 mm	610 mm	4 mm	black	1	124503
Anti-Slip Mat 91x122 cm	1220 mm	910 mm	4 mm	black	1	124501
Anti-Slip Mat 30x182 cm	1820 mm	300 mm	4 mm	black	1	124500
Anti-Slip Mat 45x182 cm	1820 mm	450 mm	4 mm	black	1	124502

AGR: 08.106

CORDSTRAP Strapping system

- Easy handling
- Particularly high tear resistance
- Retensionable
- No scratching or damaging of surfaces
- Extensibility and resilience of the straps absorb jolts
- Does not rust, weather-resistant and UV-resistant
- No risk of injury

Title	PU Amount	Article No.
CORDSTRAP-CLAMB CTT-20	1	059064
CORDSTRAP-CLIP 13MM 1000STK	1	059066
CORDSTRAP-DISPENSER CSD-76	1	059065
POLY. ENCOMP. BELT 13MM 1400LM	1	059067

AGR: 08.900



Further workshop equipment

Coilstrap

Application Area

- For easy cohesiveness of metal-coiuls and other materials

Characteristics

- Polyester strap, 50 mm wide
- Infinitely variable through a velcro fastener



Title	Length (m)	Total Width	Color	PU Piece	Article No.
Coilstrap	1.5 m	50 mm	black	1	109053
Coilstrap	2.5 m	50 mm	black	1	109054

AGR: 08.900

Furniture Carrying Strap

- For all heights, because it is infinitely variable
- Comfortable carrying, no cutting in because of a broad shoulder pad

Characteristics

- Polyester strap without supportig hook



Title	Length (m)	Total Width	PU Piece	Article No.
Furniture Carrying Strap	4 m	40 mm	1	109056

AGR: 08.900

Furniture Carrying Strap Complete



Title	Length (m)	Total Width	PU Piece	Article No.
Furniture Carrying Strap	3 m	80 mm	1	109120

AGR: 08.900

Container lock TSR 4/24

- Surface hardened, strong weather-resistant steel bar
- The bar is forked at the bottom, which provides higher security
- For door poles from 200 mm - 450 mm or
 - ▶ alternativ 200 mm – 600 mm
- Flexible use / without installation
- No loose pieces
- Weight 8 kg
- Integrated 19 mm ABLOY-Cylinder (interchangeable) with
 - ▶ 3 PROTEC-key incl. key card
- Certification: VdS (No.: M 102325)
- Weather-resistant coat
- Can be painted with own colours

Application Area

- The surface hardened container lock is placed around the holders of the door pole (the bar is forked at the bottom). This ensures that the bar can not be removed after sawing through the door poles. The door remains locked.

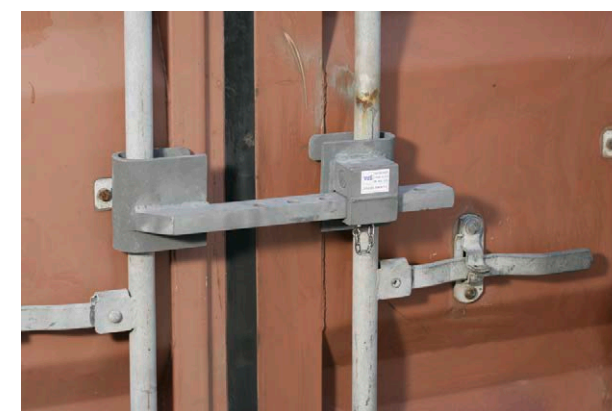
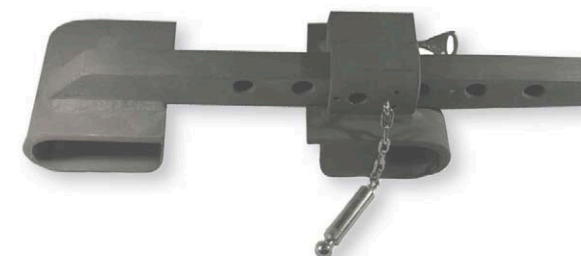
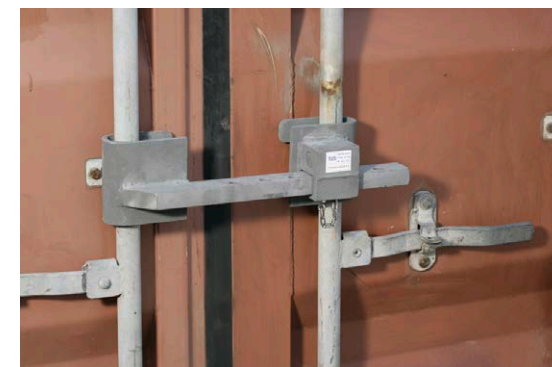

Title	PU Piece	Article No.
CONTAINER LOCK TSR 4/24	1	051227

AGR: 08.695

Steel Hand Truck 225KG

- For the transportation of heavy or big objects
- Because of the fold-out intake big objects like boxes, barrels or tyres can be transported
- The big air-filled wheels ensure a safe manoeuvring even on loose or uneven floor
- High objects also can be transported safely due to the specifically attached handle



Title	PU Piece	Article No.
HT-144395 STEEL HAND TRUCK	1	111147
AGR: 08.199		
Spare Parts	PU Amount	Article No.
SPARE WHEEL FOR 111147	1	341146

TOTAL Fire Extinguisher 6 kg

- Refillable, ready for immediate use at constant pressure
- Jet of extinguishing agent can be shut off
- Tested in accordance with DIN EN 3

Characteristics

- Portable constant pressure fire extinguisher with a 6 kg capacity, tube is weather and UV-resistant
- bracket integrated into the stable foot ring for an extinguishing nozzle, brass fitting with an integrated testing valve

Hints

1. In line with the Ordinance on Operational Safety Regulations, fire extinguishers should be replaced every 20 – 25 years
2. Fire extinguishers must be tested every 2 years and undergo a TÜV(German Association for Technical Inspection)inspection every 10 years

Scope Of Delivery

- Wall-mounting bracket



16

Title	Content	PU Piece	Article No.
TOTAL Fire Extinguisher 6 kg	6 Kg	1	032723

AGR: 04.237

Fire Extinguisher 6l Foam



Title	PU Piece	Article No.
FIRE EXTINGUISHER 6L FOAM AGR: 04.237	1	341009

FIRE EXTINGUISHER 12KG POWDER



Title	PU Piece	Article No.
FIRE EXTINGUISHER 12KG POWDER AGR: 04.237	1	362765

INTERNAL/Approved (2019-03-23 01:02:29)

Further workshop equipment

Extinguisher warning label

Title	PU Piece	Article No.
Signboard "Fire extinguisher" AGR: 08.600	1	341024



Motor vehicle bracket for extinguisher



Title	PU Piece	Article No.
Motor vehicle bracket for extinguisher AGR: 16.955	1	341368

Warning Sign High Voltage

Title	PU Piece	Article No.
Warning Sign High Voltage AGR: 08.600	1	352065



Warning Sign "Access forbidden"

Title	PU Piece	Article No.
Warning Sign "Access forbidden" AGR: 08.600	1	352066



Mandatory Sign "Gloves"

Title	PU Piece	Article No.
Mandatory Sign "Gloves" AGR: 08.600	1	352067



Mandatory Sign "Face protection"

Title	PU Piece	Article No.
Mandatory Sign "Face protection" AGR: 08.600	1	352068



Sign "Explosion protection"

Title	PU Piece	Article No.
Sign "Explosion protection" AGR: 08.600	1	352070



Sign "5 Safety Rules"

Title	PU Piece	Article No.
Sign "5 Safety Rules" AGR: 08.600	1	352069